





# ZIANG INDUSTRIES

**Certified**  
**ISO 13485:2016**  
**CE MDR 2017/ 745**





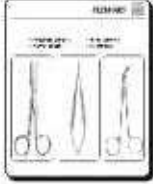

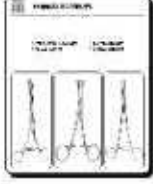
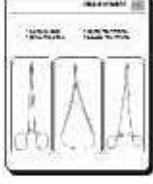
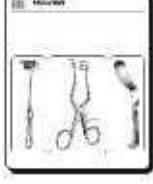
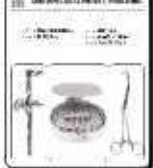



**ZIANA**  
**INDUSTRIES**

---

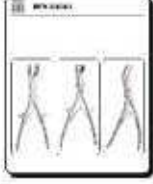
S. No.			Page No.
01	<i>Diagnostic / Preparation Instruments</i>		01
02	<i>Scalpel Holders, Amputation &amp; Saws</i>		25
03	<i>Scissors</i>		37
04	<i>Dressing &amp; Tissue Forceps</i>		95
05	<i>Haemostatic Forceps</i>		120
06	<i>Needle Holders</i>		162
07	<i>Retractors</i>		202
08	<i>Cardiovascular &amp; Thoracic Instruments</i>		289

# TABLE OF CONTENTS

S. No.			Page No.
09	<i>Intestinal &amp; Rectal Instruments</i>		331
10	<i>Urology Surgery</i>		350
11	<i>Gynecology / Obstetrics</i>		360
12	<i>Neurosurgery Instruments</i>		401
13	<i>Orthopaedics</i>		420
14	<i>Ear, Nose, Throat Surgery</i>		493
15	<i>Hollow Wares</i>		561
16	<i>Surgical Instrument Sets</i>		570

S. No.			Page No.
17	<i>Index</i>		584
18	<i>Ophthalmology Instruments</i>	<i>(Separate Catalogue)</i>	
19	<i>Dental Surgery Instruments</i>	<i>(Separate Catalogue)</i>	
20	<i>Beauty Care Instruments</i>	<i>(Separate Catalogue)</i>	
21	<i>Hospital Furniture Products</i>	<i>(Separate Catalogue)</i>	
22	<i>Veterinary Instruments</i>	<i>(Separate Catalogue)</i>	
23	<i>X-Ray (Radiology) Accessories</i>	<i>(Separate Catalogue)</i>	

# DIAGNOSTIC/PREPARATION INSTRUMENTS **ZIANA** INDUSTRIES

---

- **HAMMERS**
- **STETHOSCOPE**
- **CATHER FORCEPS**
- **LARYNGOSCOPES**
- **DISSECTING KITS**
- **CALIPERS**
- **SUCTION TUBES**
- **TROCARS**

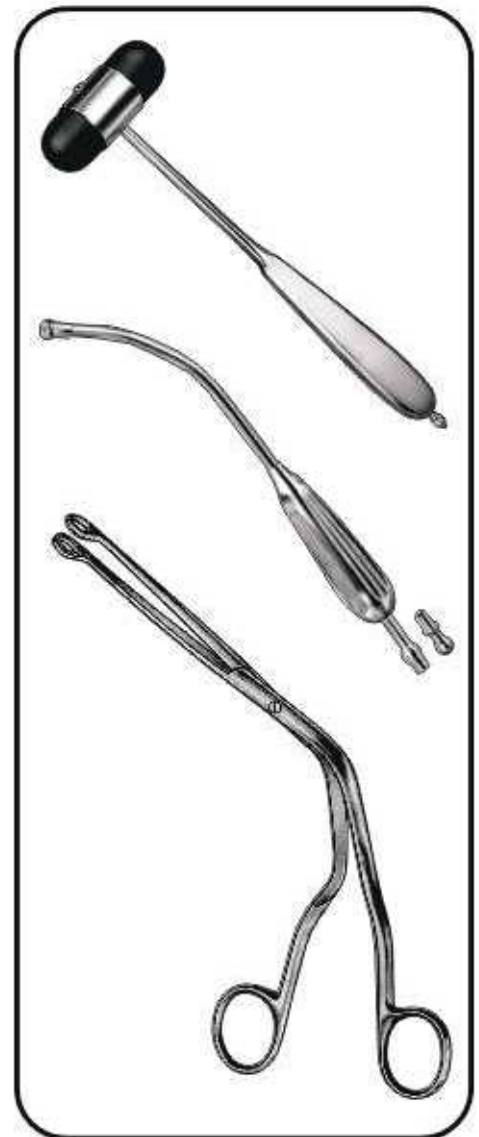
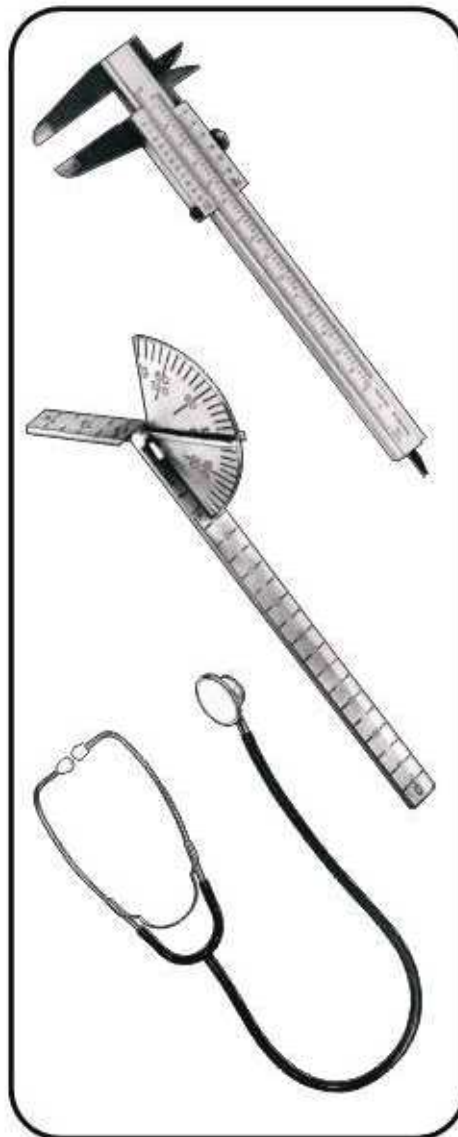



**NEURO-DUOFLEX**  
Z-11-001-220  
22 cm, 8 3/4"



**DEJERINE**  
Z-11-002-200  
20 cm, 8"



**DEJERINE**  
Z-11-003-200  
20 cm, 8"



**TROEMNER**  
Z-11-004-245 145 g  
Z-11-005-245 175 g  
Z-11-006-245 235 g  
24.5 cm, 9 3/4"  
spare rubber



**TROEMNER-SIMPLEX**  
Z-11-007-210  
21 cm, 8 1/4"



**BUCK**  
Z-11-008-185  
18.5 cm, 7 1/4"



**BUCK  
HAMMER**  
Z-11-009-180  
18 cm, 7"



**TAYLOR**  
Z-11-010-180 18 cm, 7"  
Z-11-011-200 20 cm, 8"



**TAYLOR**  
Z-11-012-180  
18 cm, 7"

Perkussionshämmer  
 Martillos de percusion

Marteaux-percuteurs  
 Martelli percussori



**BABINSKY**  
 Z-11-013-220  
 22 cm, 8 3/4"



**BABINSKY**  
 Z-11-014-220  
 22 cm, 8 3/4"



**RABINER**  
 Z-11-015-255  
 25.5 cm, 10"  
 with needle & brush



**BERLINER**  
 Z-11-016-200  
 20.0 cm, 8"



**TRAUBE**  
 Z-11-017-160  
 16 cm, 6 1/4"



**WARTENBERG**  
 Z-11-018-190  
 19 cm, 7 1/2"





**DUPLEX**  
Z-11-019-000  
super lightweight



**DUPLEX-BABY**  
Z-11-020-000  
super lightweight



**ANAESTOPHON**  
Z-11-021-000  
super lightweight



**PINARD WOODEN**  
Z-11-022-180  
18 cm, 7"



**PINARD ALUMINIUM**  
Z-11-023-150  
15 cm, 6"



**WEBER**  
Z-11-024-090  
9.0 cm, 3 1/2"  
Aesthesiometer

# CATHETER INTRODUCING FORCEPS

Kathetereinführzangen  
Pinzas para catéteres

Pinces pour introduire les sondes  
pinze per introdurre le sonda



# DIAGNOSTIC SETS WITH STANDARD ILLUMINATION

Kaltlicht-Laryngoskope und Zubehör  
Laringoscopios de luz fría y Accessories

Laryngoscopes de lumière froide et accessoires  
Laringoscopi di luce fredda ed accessori



**OTOSCOPE SET** (color available)  
Z-11-054-000



**MINI OTOSCOPE SET**  
Z-11-056-000



**OTOSCOPE SET**  
Z-11-055-000



**OTOSCOPE SET**  
Z-11-059-000



**DIAGNOSTIC SET**  
Z-11-033-000



**OTOSCOPE /  
OPHTHALMOSCOPE SET**  
Z-11-057-000



**DIAGNOSTIC SET**  
Z-11-058-000



**GUEDEL-NEGUS**  
Z-11-034-00 Battery handle only  
Fiber Optic  
Laryngoscope set  
with 4 blades  
(fig. 01 to 04) in  
wooden/ rexin box.



**MCINTOSH**  
Z-11-039-00  
Fiber Optic Laryngoscope set  
with 4 blades  
(fig. 01 to 04) in wooden/ rexin box.



Fig. 01  
Z-11-045-01

Fig. 02  
Z-11-046-02

Fig. 03  
Z-11-047-03

Fig. 04  
Z-11-048-04



**BATTERY HANDLE**  
Z-11-049-250  
without battery  
Use with battery - Size C  
(11-045-01 - 11-048-04  
11-050-01 - 11-053-04)

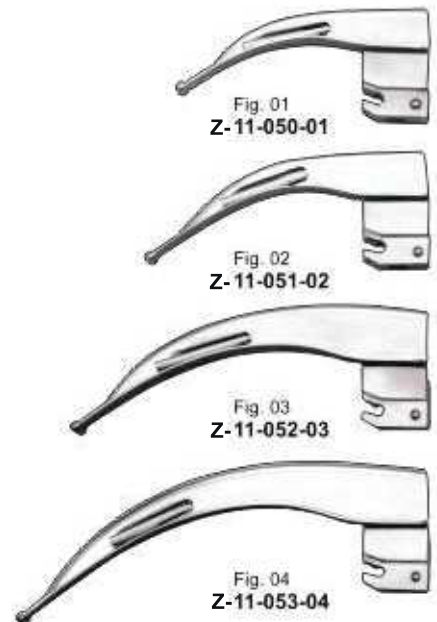

Fig. 01  
Z-11-050-01

Fig. 02  
Z-11-051-02

Fig. 03  
Z-11-052-03

Fig. 04  
Z-11-053-04



**GUEDEL-NEGUS / MILLER**

**Z-11-061-000**  
with three blade  
blades No. 1 to 3  
complete, in case.

**Z-11-062-000**  
With four blade  
blades No. 1 to 4  
complete, in case.



**FOREGGER**

**Z-11-074-000**  
with three Four Blades  
complete, in case.



**Z-11-063-001**  
for children  
working length  
70 mm



**Z-11-064-002**  
for adolescents  
working length  
90 mm



**Z-11-065-003**  
for women  
working length  
110 mm



**Z-11-066-004**  
for men  
working length  
175 mm



**Z-11-075-001**  
for children  
working length  
70 mm



**Z-11-076-002**  
for adolescents  
working length  
90 mm



**Z-11-077-003**  
for women  
working length  
110 mm



**Z-11-078-004**  
for men  
working length  
175 mm

# LARYNGOSCOPE CONVENTIONAL & FIBEROPTIC SET(DOUBLE SET)

Kaltlicht-Laryngoskope und Zubehör  
Laringoscopios de luz fría y Accessories

Laryngoscopes de lumière froide et accessories  
Laringoscopi di luce fredda ed accessori

**ZIANA**  
INDUSTRIES

## CONVENTIONAL SET



**CONVENTIONAL SET**  
Z-11-079-000  
**MAC + MILLER COMBO**  
Double Set of 10 Pcs.  
4 Miller Blades  
4 Mac Blades  
1 Handle Small  
1 Handle Medium

## FIBEROPTIC SET



**MAC + MILLER COMBO SET**  
Z-11-080-000  
Double Set of 10 Pcs.  
4 Miller Blades  
4 Mac Blades  
1 Handle Small  
1 Handle Medium

# FIBEROPTIC & DISPOSABLE LARYNGOSCOPE SET

Kaltlicht-Laryngoskope und Zubehör  
Laringoscopios de luz fría y Accessories

Laryngoscopes de lumière froide et accessoires  
Laringoscopi di luce fredda ed accessori

## FIBEROPTIC SETS



**MAC SET**  
Z-11-081-000  
Set of 5 pcs.



**MILLER SET**  
Z-11-082-000  
Set of 5 pcs.

## DISPOSABLE LARYNGOSCOPE SETS



**MAC DISPOSABLE SET**  
Z-11-083-000  
Set of 4 Blade + 1 Handle



**MILLER DISPOSABLE SET**  
Z-11-084-000  
Set of 4 Blade + 1 Handle



- Z-11-085-001**  
Set of 9 Pcs.
- Dissecting Forceps 11.5cm Sharp Point.
  - Teasing needle Sharp STR.
  - Teasing Needle Sharp Angular.
  - B.P Handle No.4.
  - Blade No. 22.
  - Thumb Forcep T.O.E 13cm.
  - Dissecting Scissor STR 11.5cm.
  - Dissecting Scissor STR 13cm.
  - Zipper Case Inside Red Velvet.



- Z-11-086-002**  
Set of 10 Pcs.
- Grooved Director with Tongue Tie 14cm.
  - Probe Double 14cm.
  - Mayo Hegar Needle Holder 14cm.
  - B.P Handle No.3
  - B.P Handle No.4
  - Dressing Scissor 14cm S/B STR.
  - Dressing Scissor 14cm S/B CVD.
  - Dressing Forcep 1x2 teeth 14cm.
  - Dressing Forcep Serrated 14cm.
  - Zipper Case Inside Red Velvet.



- Z-11-087-003**  
Set of 10 Pcs.
- Probe Double 13cm.
  - 2PCS, Scalpel S.S.
  - Grooved Director With Tongue Tie 14cm.
  - Mayo Hegar Needle Holder 14cm.
  - Dissecting Forceps 14cm 1x2 Teeth.
  - Dressing Forceps 14cm Serrated.
  - Dressing Scissor 14cm S/B STR.
  - Dressing Scissor 14cm S/B CVD.
  - Zipper Case Inside Red Velvet.



- Z-11-088-004**  
Set of 10 Pcs.
- Blow Pipe.
  - 3PCS Scalpel.
  - Dissecting Forceps 14cm.
  - Grooved Director With Tongue Tie 14cm
  - Triple Chain Hook.
  - Dressing Scissor Probe Pointed 14cm.
  - Probe Double 14 cm.
  - Zipper Case Inside Red Velvet.



**DISSECTING SET**  
Z-11-089-005 Containing 9 Instruments

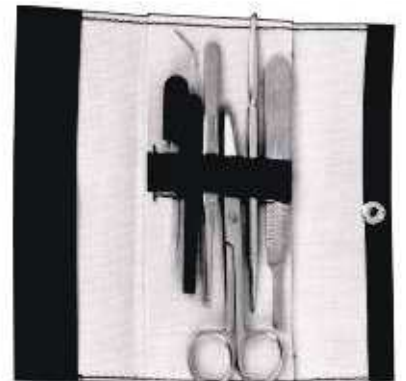

**Z-11-090-006**  
Set of 6 pcs.

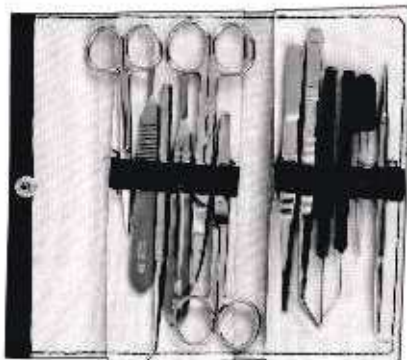

**Z-11-091-007**  
Set of 12 pcs.



**DISSECTING KET**  
Z-11-092-008  
Set of 2 pcs.



# CALIPERS, DYNAMOMETERS, FLEXOMETER

Schieblehren, Dynamometer, Winkelmesser  
Calipers, Dinamómetros, Goniómetro

Pieds à Coulisse, Dynamomètres, Goniomètres  
Calibro, Dinamometro, Goniometro



**GRADUATED TAPE MEASURER**

Z-11-093-001  
2 m long (1.5 m) graduated  
in inch & cm markings



Z-11-094-150  
15 cm, 6"  
cm & mm  
markings

**GRADUATED METAL RULER**



**JAMESON**  
Z-11-095-001



**TOWNLEY**  
Z-11-096-115  
11.5 cm, 4 1/4"



**MÖLTGEN**  
Z-11-097-001



**CARROLL**  
Z-11-098-145  
14.5 cm, 5 3/4"



**CALIPER**  
Z-11-099-150  
15.0 cm, 6"



**VERNIER**  
Z-11-100-120  
12 cm, 5"



**CASTROVIEJO-EPKER**  
Z-11-101-090  
9 cm, 3 1/2"  
Measuring range  
40 mm



**CASTROVIEJO-EPKER**  
Z-11-102-180  
18 cm, 7"  
Measuring range  
40 mm, straight



**CASTROVIEJO-EPKER**  
Z-11-103-180  
18 cm, 7"  
Measuring range  
40 mm, curved



**CASTROVIEJO**  
Z-11-104-080  
8 cm, 3"  
Measuring range  
15 mm



**CASTROVIEJO**  
Z-11-105-080  
8 cm, 3"  
Measuring range  
20 mm



**CASTROVIEJO**  
Z-11-106-080  
8 cm, 3"  
Measuring range  
20 mm

Ø 1.5 mm



**COUPLAND**  
Z-11-107-001

Ø 2.0 mm



**BYRD**  
Z-11-108-01 1.5 mm  
Z-11-109-02 2.5 mm  
Z-11-110-03 3.5 mm

Ø 8.0 mm



**COOLEY**  
Z-11-111-330  
33.0 cm, 13"



**MILLIN'S SUCTION TUBE**  
Z-11-112-001  
chromium-plated,  
with sliding "on & off"  
action.

Ø 8.0 mm



**COOLEY**  
Z-11-113-350  
35 cm, 13 3/4"

Ø 6.0 mm



**COOLEY**  
Z-11-114-300  
30.0 cm, 12"

Ø 10.0 mm



**COOLEY**  
Z-11-115-310  
31.0 cm, 12 1/4"



**Z-11-116-170**  
17 cm, 6 1/4"  
For aspirating fluid from the excretory ducts of large glands and for keeping the operating area clear



**Z-11-117-150**  
15 cm, 6"  
For aspirating fluid from the excretory ducts of large glands and for keeping the operating area clear



**Z-11-118-190**  
19 cm, 8 1/4"  
For aspirating fluid from the excretory ducts of large glands and for keeping the operating area clear



**BIEMER**  
Z-11-119-004 Ø 4 mm  
Z-11-120-006 Ø 6 mm  
Z-11-121-008 Ø 8 mm  
Z-11-122-010 Ø 10 mm  
Z-11-123-012 Ø 12 mm  
Z-11-124-014 Ø 14 mm  
Curettes for aspiration lipectomy, graduated, slightly curved



**BIEMER**  
Z-11-125-004 Ø 4 mm  
Z-11-126-006 Ø 6 mm  
Curettes for aspiration lipectomy, with three apertures, slightly curved malleable



**BIEMER**  
Z-11-127-008 Ø 8 mm  
Z-11-128-010 Ø 10 mm  
Z-11-129-012 Ø 12 mm  
Curettes for aspiration lipectomy, with three apertures, slightly curved malleable



Ø 11 mm

Ø 7.5 mm

**Z-11-130-230**  
23 cm, 9"  
double curved  
for general  
surgery

**Z-11-131-190**  
19 cm, 8 1/4"  
double curved  
for general  
surgery

**Z-11-132-220**  
22 cm, 8 1/4"  
double curved  
for general  
surgery

**TROCAR**  
**Z-11-133-170**  
17 cm, 6 1/4"  
For puncturing

**HOLLOW NEEDLE**  
**Z-11-134-150**  
15 cm, 6"  
sharp



**POOL**  
**Z-11-135-225**  
22.5 cm, 9"  
Suction cannula  
with outer tube  
to be screwed



**POOL**  
**Z-11-136-225**  
22.5 cm, 9"  
Suction cannula  
with outer tube  
to be screwed



**Z-11-137-180**  
18 cm, 7"  
for tonsillectomy,  
oral and laryngeal  
operations



**Z-11-138-220**  
22 cm, 8 1/2"  
suction cannula  
for tonsillectomy,  
oral and laryngeal  
operations



**Z-11-139-180**  
18 cm, 7"  
suction cannula  
for tonsillectomy,  
oral and laryngeal  
operations



**Z-11-140-170**  
17 cm, 6 3/4"  
S-shaped blunt cannula  
for aspirating fluid from  
the excretory ducts of  
large glands and for  
keeping the operations  
area clear



Sauger, Saugrohre  
 Tubos de aspiración



**ADSON**  
 Z-11-147-150 4 mm Ø  
 15 cm, 6"



**ADSON**  
 Z-11-148-150 4 mm Ø, 15 cm, 6"  
 Z-11-149-200 4 mm Ø, 20 cm, 8"  
 Z-11-150-200 5 mm Ø, 20 cm, 8"



**PLESTER**  
 Z-11-151-01 1.5 mm Ø  
 Z-11-152-02 2.0 mm Ø  
 Z-11-153-03 2.5 mm Ø  
 Z-11-154-04 3.0 mm Ø



**FRAZIER-FERGUSON**  
 Z-11-155-114 6 Fr.  
 Z-11-156-114 7 Fr.  
 Z-11-157-114 9 Fr.  
 Z-11-158-114 10 Fr.  
 Z-11-159-114 11 Fr.  
 Z-11.4 cm, 4 1/2"



**FRAZIER**  
 Z-11-160-190 6 Fr.  
 Z-11-161-190 7 Fr.  
 Z-11-162-190 9 Fr.  
 Z-11-163-190 11 Fr.  
 19 cm, 7 1/2"



**FRAZIER 30°**  
 Z-11-164-180 6 Fr.  
 Z-11-165-180 7 Fr.  
 Z-11-166-180 8 Fr.  
 Z-11-167-180 9 Fr.  
 Z-11-168-180 10 Fr.  
 Z-11-169-180 11 Fr.  
 Z-11-170-180 12 Fr.  
 Z-11-171-180 15 Fr.  
 18 cm, 7"



**FRAZIER 45°**  
 Z-11-172-180 6 Fr.  
 Z-11-173-180 7 Fr.  
 Z-11-174-180 8 Fr.  
 Z-11-175-180 9 Fr.  
 Z-11-176-180 10 Fr.  
 Z-11-177-180 11 Fr.  
 Z-11-178-180 12 Fr.  
 18 cm, 7"





Z-11-179-175 Ø 4.5 mm  
Z-11-180-175 Ø 5.5 mm  
17.5 cm, 7"  
Nasal suction tubes



**GORNEY**  
Z-11-181-180  
18 cm, 7"  
suction dissector



Z-11-182-200 4 mm wide  
Z-11-183-200 5 mm wide  
20 cm, 8"  
suction raspatories, sharp, bayonet-shaped, with styelt



**LOPEZ-REINKE**  
Z-11-184-235  
23.5 cm, 9"  
tonsil dissector with suction device



**PLESTER**  
19.5 cm, 8"  
with finger cut-off and stylet, thumb piece parallel to curved, with Luer hub



**FERGUSSON**  
18 cm, 7"  
with finger cut-off and stylet, thumb piece 90° to curved, with Luer hub



**FERGUSSON**  
Z-11-194-180 Ø 4.0 mm  
18 cm, 7"  
insulated, with finger cut-off and stylet, thumb piece 90° to curved, with Luer hub



**FRAZIER**  
Z-11-195-180 Ø 3.0 mm  
Z-11-196-180 Ø 5.0 mm  
18 cm, 7"  
insulated, with finger cut-off and stylet, thumb piece 90° to curved, with Luer hub



**Z-11-197-180**  
18 cm, 7"  
Ø 5.0 mm diam., Tip 6.5 mm wide nasal section tube, with luer hub

Trokare, Saugrohre  
Trócares, Tubos de aspiración

Trocarts, Tubos d aspiracion  
Trequarti, Tubi d aspirazion

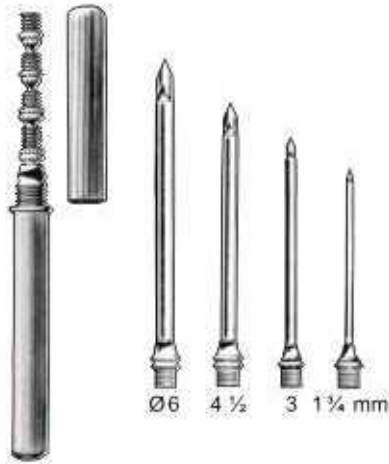

**UNIVERSAL**  
Z-11-198-01  
Set of 3 Pieces  
Z-11-199-02  
Set of 4 Pieces



**LUER**  
Z-11-200-01  
Luer lock adapter



**UNIVERSAL**  
Z-11-201-140  
14 cm, 5 1/2"



**LICHTWITZ**  
Z-11-202-185  
18.5 cm, 7 1/4"  
antrum trocar



**FRAZIER**



**YANKAUER**  
Z-11-205-270  
27 cm, 10 3/4"



**ANDREWS-PYNCHON**  
Z-11-206-235  
23.5 cm, 9 1/4"

Fig.	Item	Description	W.L	Tip
A	11-203-180	(18 cm, 7") Angled-75°	4.75"	10 French
B	11-204-180	(18 cm, 7") Angled-75°	4.75"	12 French



**STANDARD**  
18.5 cm, 7 1/4"

With stopcock and drain

- Z-11-207-185 3 mm x 80 mm
- Z-11-208-185 4 mm x 80 mm
- Z-11-209-185 5 mm x 80 mm
- Z-11-210-185 6 mm x 80 mm



**STANDARD**  
18.5 cm, 7 1/4"

With Stopcock

- Z-11-211-185 3 mm x 80 mm
- Z-11-212-185 4 mm x 80 mm
- Z-11-213-185 5 mm x 80 mm
- Z-11-214-185 6 mm x 80 mm



**NELSON**

Abdominal Trocars

- Z-11-215-170 3.0 mm x 80 mm 17.0 cm, 6 3/4"
- Z-11-216-170 4.0 mm x 80 mm 17.0 cm, 6 3/4"
- Z-11-217-170 5.0 mm x 80 mm 17.0 cm, 6 3/4"
- Z-11-218-170 6.0 mm x 80 mm 17.0 cm, 6 3/4"
- Z-11-219-210 7.5 mm x 110 mm 21.0 cm, 8 1/4"
- Z-11-220-210 9.5 mm x 110 mm 21.0 cm, 8 1/4"
- Z-11-221-210 11.0 mm x 110 mm 21.0 cm, 8 1/4"

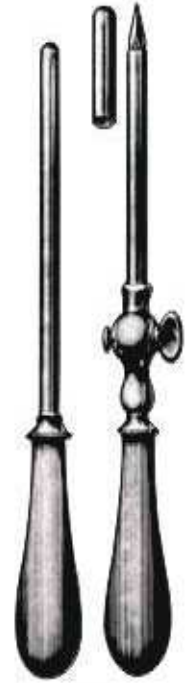

**BUELAU**

- Z-11-222-240 8 mm  
24.0 cm, 9 1/2"



**FLEURANT**  
Z-11-223-230  
23 cm, 9"  
5 mm Ø



**FLEURANT**  
Z-11-224-230  
23 cm, 9"  
5 mm Ø



**FLEURANT**  
Z-11-225-230  
23 cm, 9"  
5 mm Ø



**DOUGLAS**  
Z-11-226-03  
3 mm Ø



Z-11-227-110  
11 cm, 4 1/2"



**OCHSNER**

Gall Bladder Trocars

- Z-11-228-140 4.0 mm x 100 mm
- Z-11-229-140 5.5 mm x 100 mm
- Z-11-230-140 6.5 mm x 100 mm
- Z-14.0 cm, 5 1/2"



**LICHTWITZ**

Antrum Trocars

- Z-11-231-001
- 1.8 mm



**PIERCE**

- Z-11-232-004
- 4.0 mm



**KRAUSE**

- Z-11-233-005
- 5.5 mm



**KRAUSE**

- Z-11-234-005
- 5.5 mm



**COAKLEY**

- Z-11-235-002
- 2.25 mm



**LANDAU**

- Z-11-236-002
- 2.0 mm



**VOGEL**

- Dilatation Forceps
- Z-11-237-265
- 26.5 cm, 10 1/2"



**DUKE**

- Z-11-238-110
- 11 cm, 4 1/4"
- 5.5 mm



**BIRCH**

- Z-11-239-180
- 18 cm, 7"
- 4.5 mm



**NELSON**

- 21 cm, 8 1/4"



- 11-240-210
- 21 cm, 8 1/4"



- 11-241-210
- 21 cm, 8 1/4"



- Z-11-242-210
- 21 cm, 8 1/4"



- Z-11-243-210
- 21 cm, 8 1/4"

Ø 1.75 mm

**WULLSTEIN**

**Z-11-244-160**

16 cm, 5 3/4"

Suction tube, conical, silver, oliver  
with LUER hub

**WULLSTEIN**

**Z-11-245-160** Ø 1.5 mm

**Z-11-246-160** Ø 2.0 mm

16 cm, 5 3/4"

Suction tube, cylindrical, silver, with  
stylet with LUER hub

Usable length

**YASARGIL** usable length diam.

<b>Z-11-247-130</b>	13 cm, 5"	1.5 mm
<b>Z-11-248-150</b>	15 cm, 6"	1.5 mm
<b>Z-11-249-180</b>	18 cm, 7"	1.5 mm
<b>Z-11-250-220</b>	22 cm, 8 3/4"	1.5 mm
<b>Z-11-251-130</b>	13 cm, 5"	2.0 mm
<b>Z-11-252-150</b>	15 cm, 6"	2.0 mm
<b>Z-11-253-180</b>	18 cm, 7"	2.0 mm
<b>Z-11-254-220</b>	22 cm, 8 3/4"	2.0 mm

**YASARGIL** usable length diam.

<b>Z-11-255-130</b>	13 cm, 5"	2.5 mm
<b>Z-11-256-150</b>	15 cm, 6"	2.5 mm
<b>Z-11-257-180</b>	18 cm, 7"	2.5 mm
<b>Z-11-258-220</b>	22 cm, 8 3/4"	2.5 mm
<b>Z-11-259-130</b>	13 cm, 5"	3.5 mm
<b>Z-11-260-150</b>	15 cm, 6"	3.5 mm
<b>Z-11-261-180</b>	18 cm, 7"	3.5 mm
<b>Z-11-262-220</b>	22 cm, 8 3/4"	3.5 mm
<b>Z-11-263-180</b>	18 cm, 7"	4.5 mm

Ø 6.5-9 mm  
with LUER hub

**LANDOLT**

**Z-11-264-150**

15 cm, 6"

diam Ø 3mm

**Z-11-265-008** 08 mm / curved

**Z-11-266-011** 11 mm / curved

**Z-11-267-015** 15 mm / curved

Ø 3.5 mm

**Z-11-268-350** 35 cm, 14"

**Z-11-269-500** 50 cm, 20"

with rubber tip,  
with LUER hub

Ø 2.0 mm

Ø 9 mm

**Z-11-270-250** Ø 2.0 mm

**Z-11-271-250** Ø 2.5 mm

**Z-11-272-250** Ø 3.0 mm

25 cm, 10"

with finger cut-off  
thumb piece 90 to  
curved, with luer hub

Ø 6-9 mm



**FINSTERER**  
Z-11-273-320  
32 cm, 12 1/4"

Ø 9-13 mm

Ø 15 mm

Ø 2 mm

Ø 4.5 mm

**YASARGIL**  
LURE-LOCK Cone  
Z-11-274-200  
20 cm, 8"

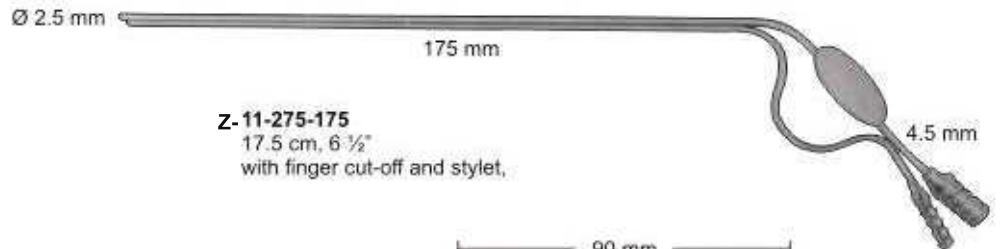

Z-11-275-175  
17.5 cm, 6 1/2"  
with finger cut-off and stylet,

4.5 mm

90 mm

**HOUSE**  
Z-11-276-001

	Suction tube diam.	irrigationtube diam.
Z-11-277-001	0.9 mm	0.7 mm
Z-11-278-002	1.2 mm	0.9 mm
Z-11-279-003	1.5 mm	1.2 mm

with finger cut-off and stylet,  
with lure hub

4 mm

Ø 9-6 mm



Z-11-280-001 3.5 mm  
with LURE-LOCK cone

Ø 9 mm

**LANDOLT**  
Z-11-281-001  
With finger cut-off and stylet, can be sterilized in an autoclave up to 3 bar (143 c)

Connection for suction hose

Ø 7.5-12 mm

4 mm diam., Untrashed contact to be touched by HF-electrodes

- **SCALPEL HOLDERS**
- **DISSECTING KNIVES**

- **AMPUTATION KNIVES**
- **SAWS**

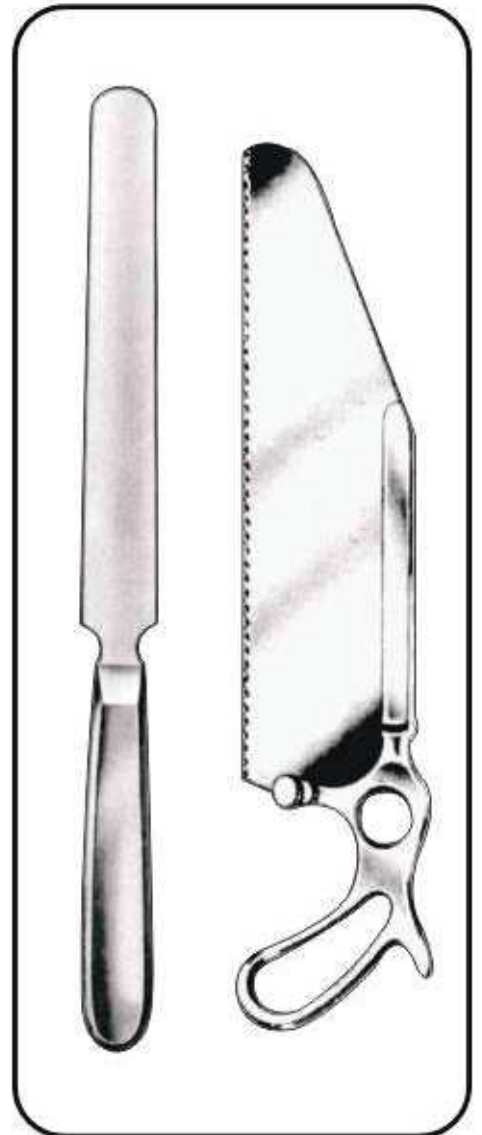
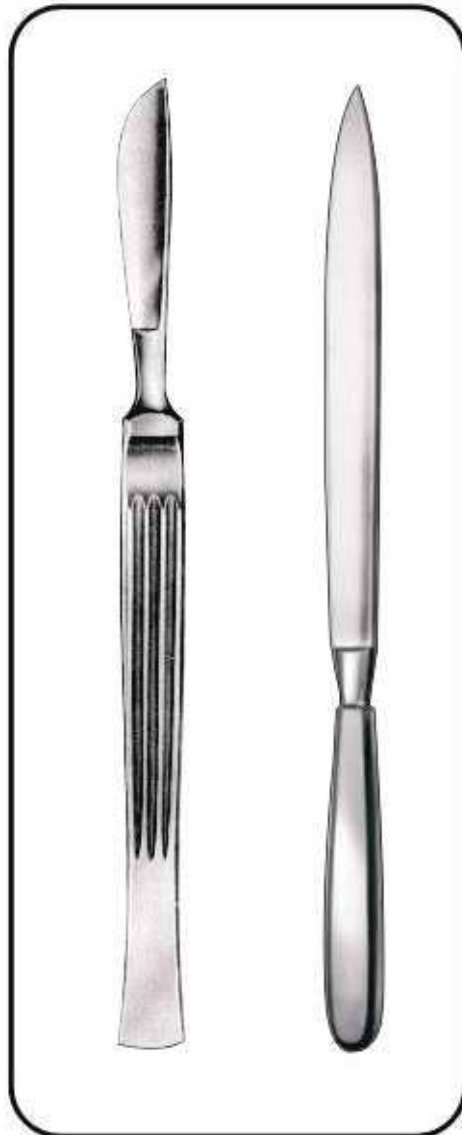

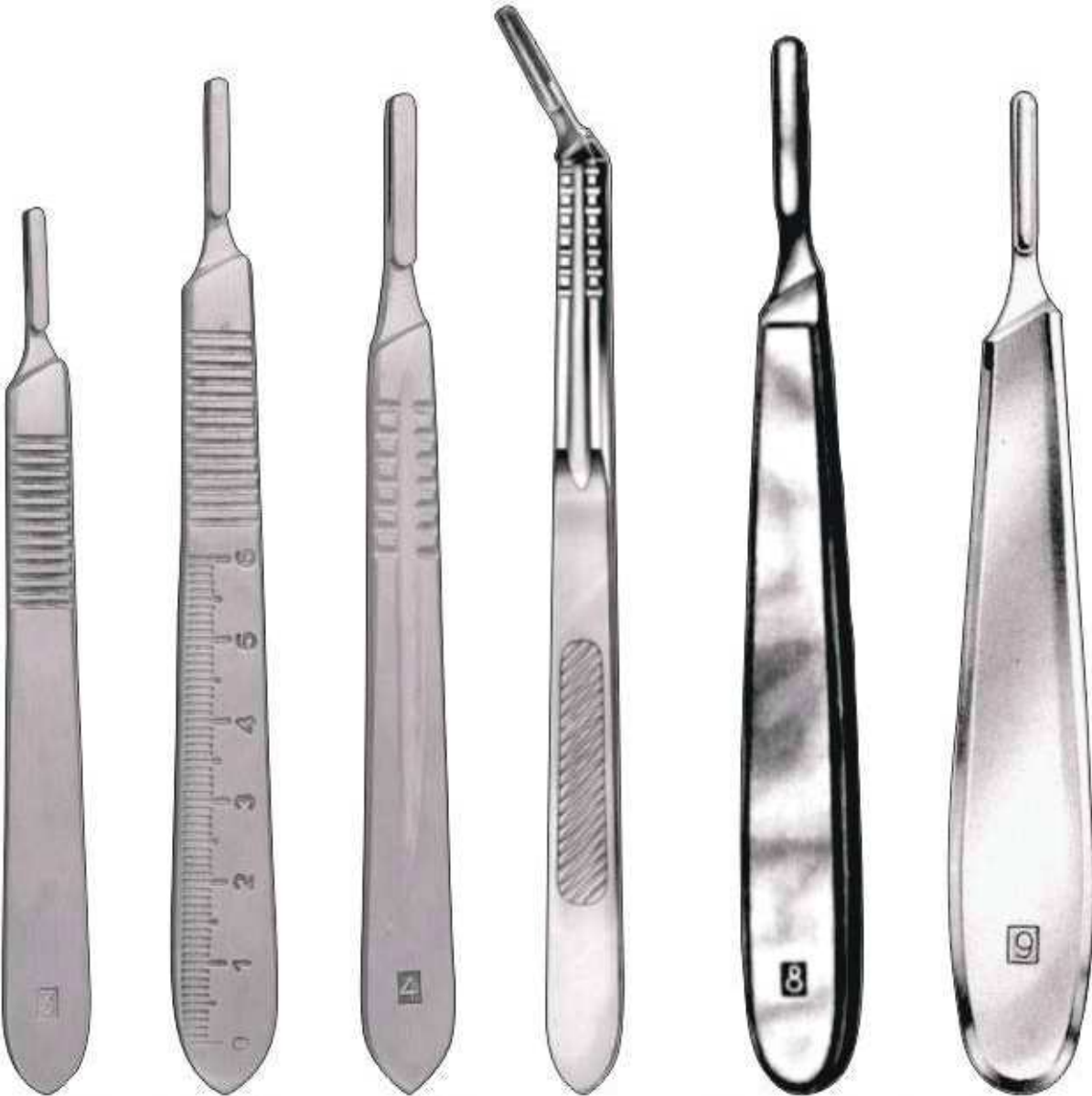

Blade Sizes



Blade Sizes

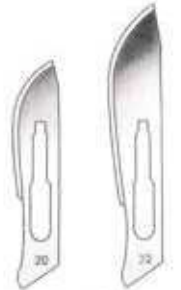

Blade Sizes

**#3 SCALPEL HANDLE**  
Z-13-001-120  
12.75 cm, 5"  
Blade Size  
10, 11, 12, 15

**#3 SCALPEL HANDLE/GRADUATED**  
Z-13-002-120  
12.75 cm, 5"  
Blade Size  
10, 11, 12, 15

**#4 SCALPEL HANDLE**  
Z-13-003-120  
12.75 cm, 5"  
Blade Size  
20, 22, 25

**4L SCALPEL HANDLE**  
Z-13-004-210  
21 cm, 8 1/4"

**SCALPEL PLASTIC HANDLE**  
Z-13-005-08  
# 8

**COLLIN**  
Z-13-006-09  
# 9





**SCALPEL  
PLASTIC  
HANDLE**  
Z-13-007-05  
# 5



**SCALPEL  
PLASTIC  
HANDLE**  
Z-13-008-06  
# 6



**#3, #4 SCALPEL  
HANDLE**  
Z-13-009-160  
16 cm, 6"



**SCALPEL  
HANDLE  
3L LONG**  
Z-13-010-120  
21 cm, 8 1/4"  
Blade Size  
10, 11, 12, 15



**#7 SCALPEL  
HANDLE**  
Z-13-011-160  
16.5 cm, 6 1/4"  
Blade  
10, 11, 12, 15



**SCALPEL  
HANDLE  
4L long**  
Z-13-012-210  
21 cm, 8 1/4"



**#3 SCALPEL HANDLE /  
LONG ANGLED**  
Z-13-013-200  
20.25 cm, 8 1/4"  
Blade Size  
10, 11, 12, 15



**SCALPEL  
HANDLE**  
Z-13-014-160  
16 cm, 6 1/4"



**SCALPEL  
HANDLE**  
Z-13-015-115  
11.5 cm, 4 1/2"



**SCALPEL  
HANDLE**  
Z-13-016-127  
12.7 cm, 5"



**SCALPEL  
HANDLE**  
Z-13-017-127  
12.7 cm, 5"



**SCALPEL  
HANDLE**  
Z-13-018-110  
11 cm, 4 1/4"



**SCALPEL  
HANDLE**  
Z-13-019-135  
13.5 cm, 5 1/2"



**SCALPEL  
HANDLE**  
Z-13-020-120  
12 cm, 4 3/4"



**KAYE**  
Z-13-021-150  
15 cm, 5 1/4"



**CORWIN ROUND**  
Z-13-022-145  
14.5 cm, 5 1/2"  
Blade Size  
10, 11, 12, 15



**SCALPEL HANDLE**  
Z-13-023-140  
14 cm, 5 1/2"



**SCALPEL HANDLE**  
Z-13-024-155  
15.5 cm, 6"



**TROUTMAN-CHRIS**  
Z-13-025-090  
9 cm, 3 1/2"



**TROUTMAN-CHRIS**  
Z-13-026-090  
9 cm, 3 1/2"



**BLADE HOLDER  
BLADE BREAKER**  
Z-13-027-110  
11 cm, 4 1/4"



**CASTROVIEJO**  
Z-13-028-130  
13 cm, 5 1/4"

Anatomische skalpelle  
 Bisturios para disección

Bistouris à dissection  
 Bisturios para disección



**DIEFFENBACH**  
 16 cm, 6 1/4"



Fig. 1  
 Z-13-029-160  
 16 cm, 6 1/4"

Fig. 2  
 Z-13-030-160  
 16 cm, 6 1/4"

Fig. 3  
 Z-13-031-160  
 16 cm, 6 1/4"

Fig. 4  
 Z-13-032-160  
 16 cm, 6 1/4"

Fig. 5  
 Z-13-033-160  
 16 cm, 6 1/4"



Fig. 6  
 Z-13-034-160  
 16 cm, 6 1/4"

Fig. 7  
 Z-13-035-160  
 16 cm, 6 1/4"

Fig. 8  
 Z-13-036-160  
 16 cm, 6 1/4"

Fig. 9  
 Z-13-037-160  
 16 cm, 6 1/4"

Fig. 15  
 Z-13-038-160  
 16 cm, 6 1/4"

Fig. 16  
 Z-13-039-160  
 16 cm, 6 1/4"

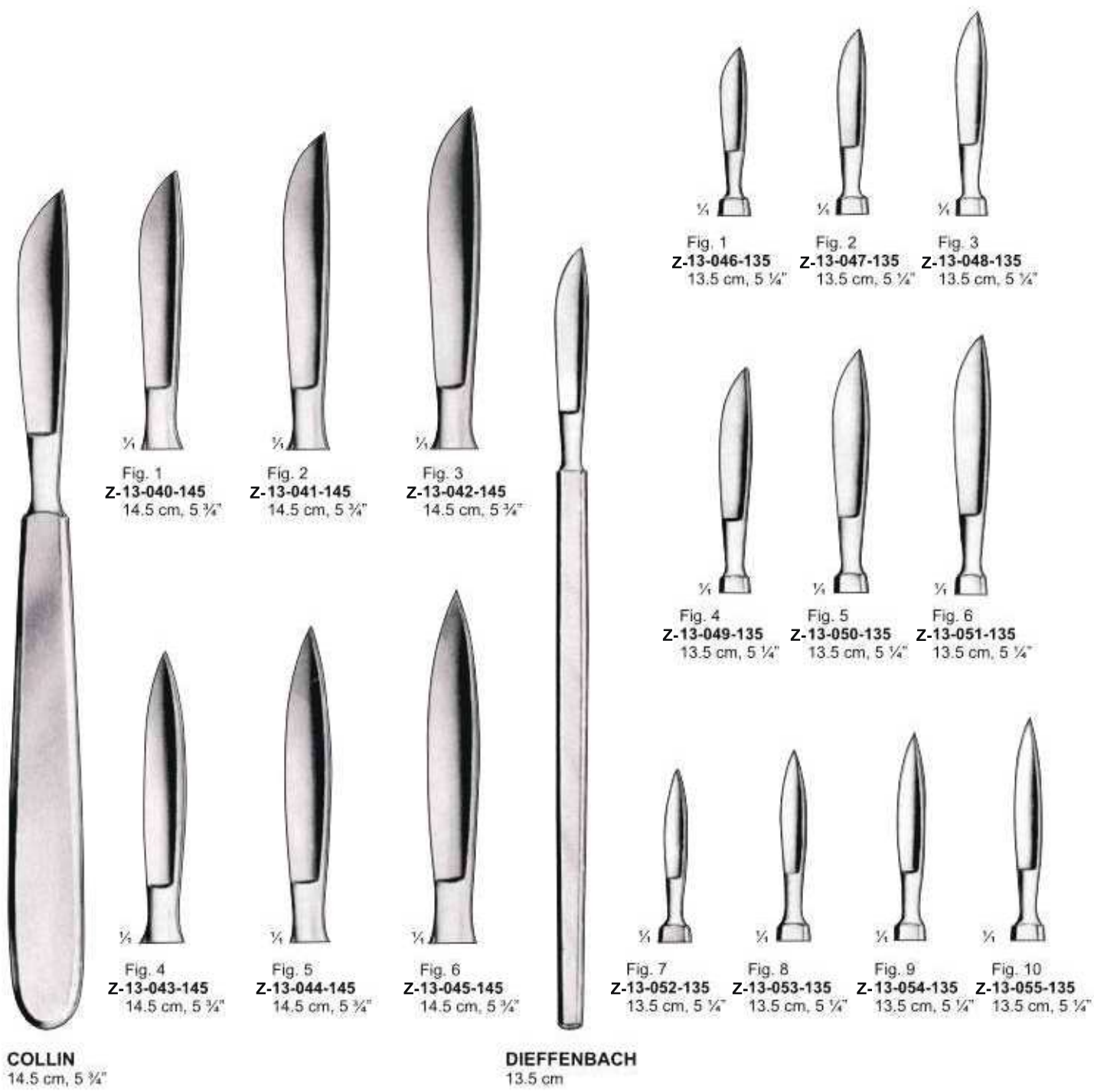

Fig. 1  
Z-13-040-145  
14.5 cm, 5 3/4"

Fig. 2  
Z-13-041-145  
14.5 cm, 5 3/4"

Fig. 3  
Z-13-042-145  
14.5 cm, 5 3/4"

Fig. 4  
Z-13-043-145  
14.5 cm, 5 3/4"

Fig. 5  
Z-13-044-145  
14.5 cm, 5 3/4"

Fig. 6  
Z-13-045-145  
14.5 cm, 5 3/4"

Fig. 1  
Z-13-046-135  
13.5 cm, 5 1/4"

Fig. 2  
Z-13-047-135  
13.5 cm, 5 1/4"

Fig. 3  
Z-13-048-135  
13.5 cm, 5 1/4"

Fig. 4  
Z-13-049-135  
13.5 cm, 5 1/4"

Fig. 5  
Z-13-050-135  
13.5 cm, 5 1/4"

Fig. 6  
Z-13-051-135  
13.5 cm, 5 1/4"

Fig. 7  
Z-13-052-135  
13.5 cm, 5 1/4"

Fig. 8  
Z-13-053-135  
13.5 cm, 5 1/4"

Fig. 9  
Z-13-054-135  
13.5 cm, 5 1/4"

Fig. 10  
Z-13-055-135  
13.5 cm, 5 1/4"

**COLLIN**  
14.5 cm, 5 3/4"

**DIEFFENBACH**  
13.5 cm

Anatomische skalpelle  
 Bisturías para disección



17 cm, 6 3/4"



Fig. 1  
 Z-13-056-170  
 17 cm, 6 3/4"



Fig. 3  
 Z-13-057-170  
 17 cm, 6 3/4"



Fig. 5  
 Z-13-058-170  
 17 cm, 6 3/4"



Fig. 7  
 Z-13-059-170  
 17 cm, 6 3/4"



Fig. 9  
 Z-13-060-170  
 17 cm, 6 3/4"



Fig. 10  
 Z-13-061-170  
 17 cm, 6 3/4"



Fig. 12  
 Z-13-062-170  
 17 cm, 6 3/4"



Fig. 14  
 Z-13-063-170  
 17 cm, 6 3/4"



Fig. 16  
 Z-13-064-170  
 17 cm, 6 3/4"



Fig. 18  
 Z-13-065-170  
 17 cm, 6 3/4"



**DISSECTING KNIFE**  
15 cm, 6"  
with metal handle

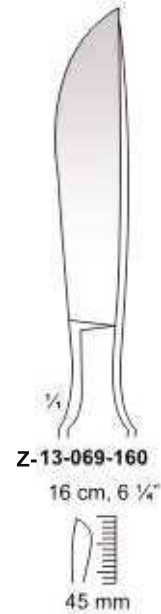
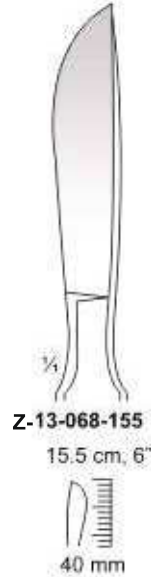
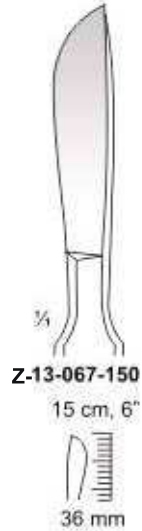
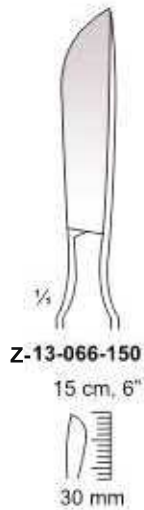

Anatomische skalpelle  
 Bisturías para disección

Bistouris à dissection  
 Bisturi para dissezione



**AYRE**  
 Z-13-076-235  
 23.5 cm, 9"  
 Cone Knife

**Z-13-077-230**  
 23 cm, 9"  
 Cone Knife

**SEGOND**  
 Z-13-078-270  
 27 cm, 11"  
 Myomatome

**OLIVECRONA**  
 Z-13-079-205  
 20.5 cm, 8"  
 Trigeminal knife

**Z-13-080-230**  
 23 cm, 9"  
 Trigeminal knife

**FOWLER**  
 Z-13-081-200  
 20 cm, 8"  
 Tonsil knife

**ABRAHAM**  
 Z-13-082-215  
 21.5 cm, 8 1/4"  
 Tonsil knife

**BRUNINGS**  
 Z-13-083-215  
 21.5 cm, 8 1/4"  
 Tonsil knife





**COLLIN**  
Z-13-084-130  
Z-13-085-160  
Z-13-086-190  
Z-13-087-220  
Z-13-088-280

**Blade**  
13 cm, 5"  
16 cm, 6 1/4"  
19 cm, 7 1/2"  
22 cm, 8 1/2"  
28 cm, 11 1/4"



**CATLIN**  
Z-13-089-160  
Z-13-090-190  
Z-13-091-220

**Blade**  
16 cm, 6 1/4"  
19 cm, 7 1/2"  
22 cm, 8 1/2"



**LISTON**  
Z-13-092-160  
Z-13-093-190  
Z-13-094-220

**Blade**  
16 cm, 6 1/4"  
19 cm, 7 1/2"  
22 cm, 8 1/2"



**LANGENBECK Blade**  
Z-13-095-120  
12 cm, 4 1/2"



**DIEFFENBACH**  
Z-13-096-130  
13 cm, 5"



**DIEFFENBACH**  
Z-13-097-130  
13 cm, 5"



**SIMON**  
Z-13-098-235  
23.5 cm, 9 1/4"



Fig. 1  
13-099-235



Fig. 2  
13-100-235



Fig. 3  
13-101-235



Fig. 4  
13-102-235



**WALB**  
Z-13-103-001

**WALB**  
Z-13-104-002

**WALB**  
Z-13-105-003

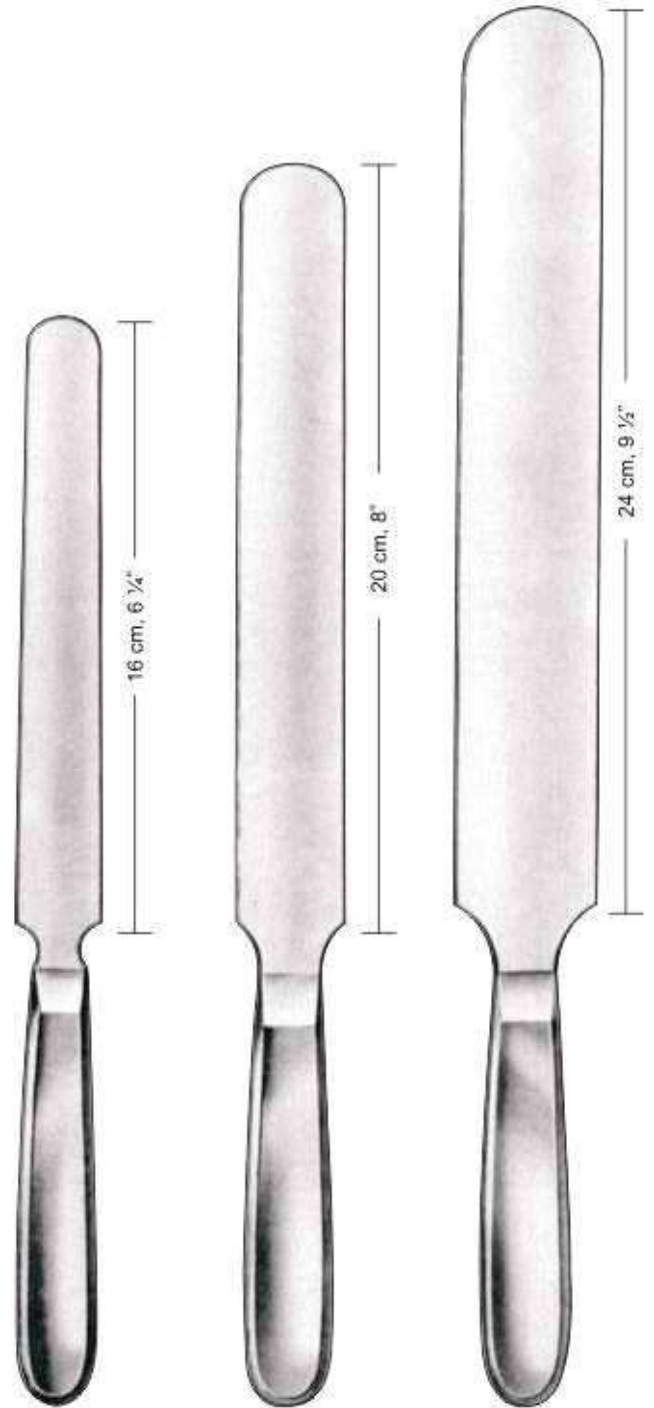

**VIRCHOW**  
Z-13-106-004

**VIRCHOW**  
Z-13-107-005

**VIRCHOW**  
Z-13-108-006

Amputationsmesser, Cuchillos para amputación  
Couteaux à amputation, coltelli per amputazione

Resektionsmesser, Cuchillos para resección  
Couteaux à résection, Coltelli per resezione



**AMPUTATION KNIFE**  
Z-13-109-290  
29 cm, 11 1/2"



**AMPUTATION KNIFE**  
Z-13-110-325  
32.5 cm, 13"



**CATLIN**  
Z-13-111-290  
29 cm, 11 1/2"



**RESECTION KNIFE**  
Z-13-112-180  
18 cm, 7"



**LANGENBECK**  
Z-13-113-180  
18 cm, 7"



**LANGENBECK**  
Z-13-114-180  
18 cm, 7"



**RAZOR**  
Z-13-115-001  
Hollow Blades On Both Sides  
Z-13-116-002  
Blade Flat / Hollow

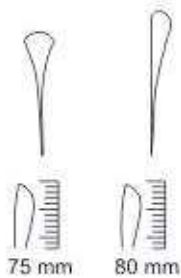

**CHARRIERE**  
Z-13-117-270 27 cm, 11"  
Z-13-118-300 30 cm, 12"



**CHARRIERE**  
Z-13-119-350  
35 cm, 13 1/4"



**SATTERLEE**  
Z-13-120-310  
31 cm, 12 1/4"



- OPERATING SCISSORS
- PLASTER SHEARS

- MICRO SCISSORS
- T.C. SCISSORS

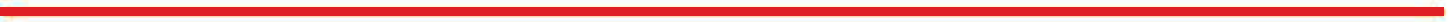
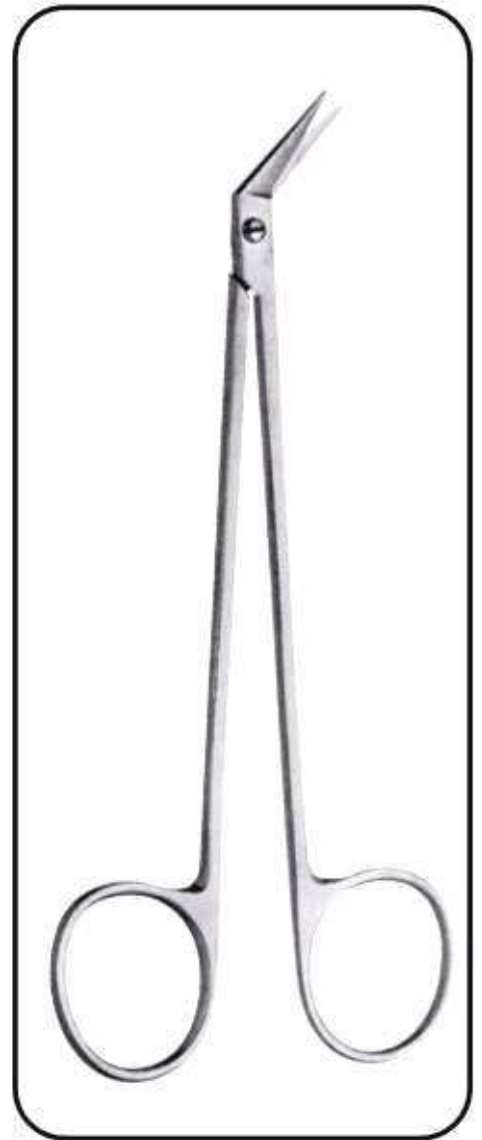
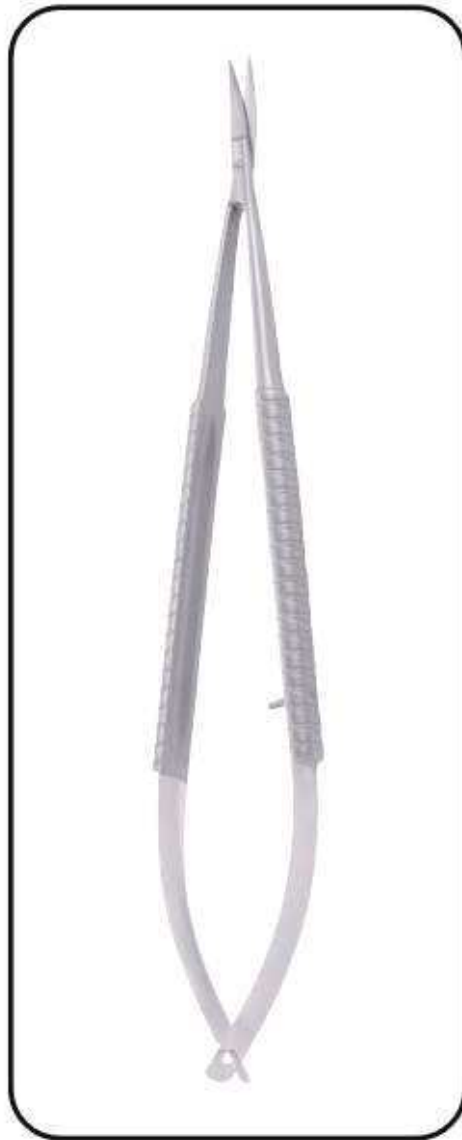
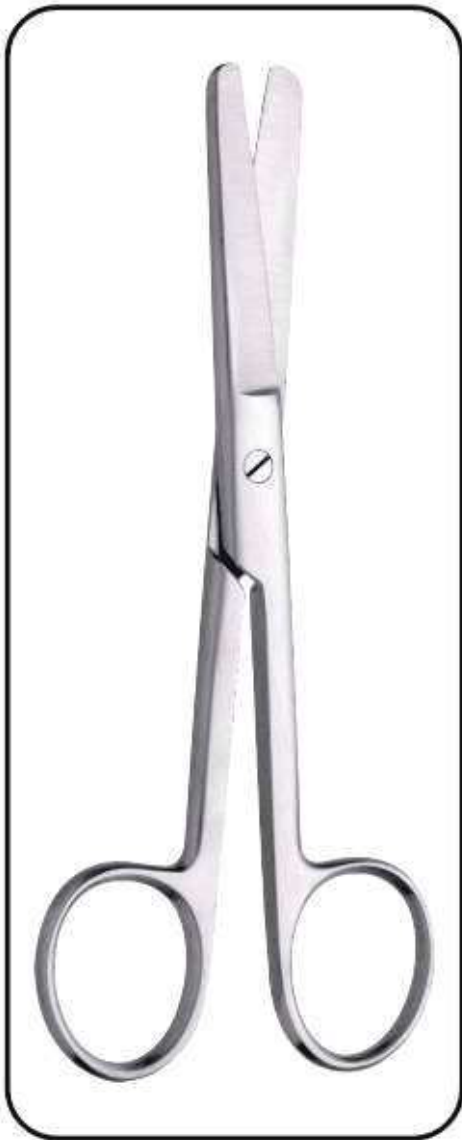

**ROUND PATTERN**

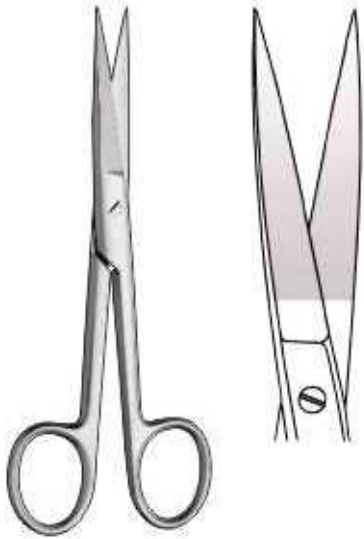

- STANDARD STRAIGHT**
- Z-15-001-115 11.5 cm, 4 1/2"
  - Z-15-002-130 13.0 cm, 5"
  - Z-15-003-140 14.0 cm, 5 1/2"
  - Z-15-004-150 15.0 cm, 6"
  - Z-15-005-160 16.0 cm, 6 1/4"
  - Z-15-006-175 17.5 cm, 7"
  - Z-15-007-185 18.5 cm, 7 1/4"
  - Z-15-008-200 20.0 cm, 8"
- S/S Str.

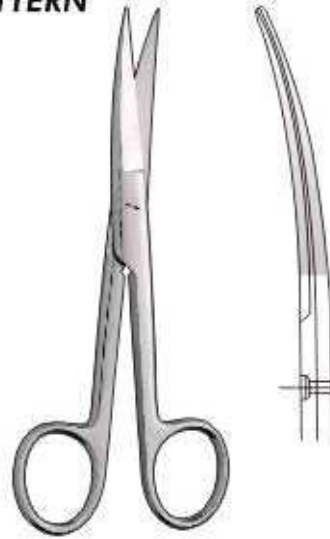

- STANDARD CURVED**
- Z-15-009-115 11.5 cm, 4 1/2"
  - Z-15-010-130 13.0 cm, 5"
  - Z-15-011-140 14.0 cm, 5 1/2"
  - Z-15-012-150 15.0 cm, 6"
  - Z-15-013-160 16.0 cm, 6 1/4"
  - Z-15-014-175 17.5 cm, 7"
  - Z-15-015-185 18.5 cm, 7 1/4"
  - Z-15-016-200 20.0 cm, 8"
- S/S Cvd.

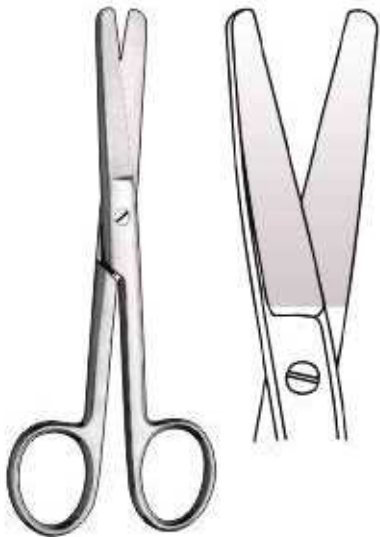

- STANDARD STRAIGHT**
- Z-15-017-115 11.5 cm, 4 1/2"
  - Z-15-018-130 13.0 cm, 5"
  - Z-15-019-140 14.0 cm, 5 1/2"
  - Z-15-020-150 15.0 cm, 6"
  - Z-15-021-160 16.0 cm, 6 1/4"
  - Z-15-022-175 17.5 cm, 7"
  - Z-15-023-185 18.5 cm, 7 1/4"
  - Z-15-024-200 20.0 cm, 8"
- B/B Str.



- STANDARD CURVED**
- Z-15-025-115 11.5 cm, 4 1/2"
  - Z-15-026-130 13.0 cm, 5"
  - Z-15-027-140 14.0 cm, 5 1/2"
  - Z-15-028-150 15.0 cm, 6"
  - Z-15-029-160 16.0 cm, 6 1/4"
  - Z-15-030-175 17.5 cm, 7"
  - Z-15-031-185 18.5 cm, 7 1/4"
  - Z-15-032-200 20.0 cm, 8"
- B/B Cvd.



- STANDARD STRAIGHT**
- Z-15-033-115 11.5 cm, 4 1/2"
  - Z-15-034-130 13.0 cm, 5"
  - Z-15-035-140 14.0 cm, 5 1/2"
  - Z-15-036-150 15.0 cm, 6"
  - Z-15-037-160 16.0 cm, 6 1/4"
  - Z-15-038-175 17.5 cm, 7"
  - Z-15-039-185 18.5 cm, 7 1/4"
  - Z-15-040-200 20.0 cm, 8"

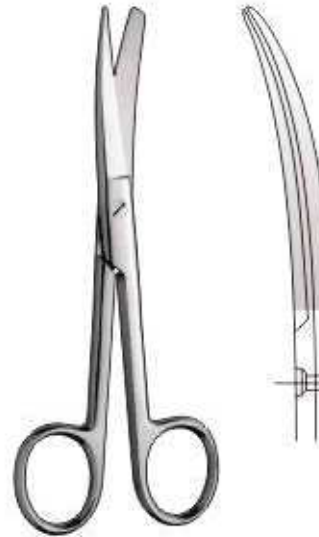

- STANDARD CURVED**
- Z-15-041-115 11.5 cm, 4 1/2"
  - Z-15-042-130 13.0 cm, 5"
  - Z-15-043-140 14.0 cm, 5 1/2"
  - Z-15-044-150 15.0 cm, 6"
  - Z-15-045-160 16.0 cm, 6 1/4"
  - Z-15-046-175 17.5 cm, 7"
  - Z-15-047-185 18.5 cm, 7 1/4"
  - Z-15-048-200 20.0 cm, 8"

Chirurgische scheren  
 Tijeras quirúrgicas

Ciseaux chirurgicaux  
 Forbici per chirurgia

FLAT PATTERN

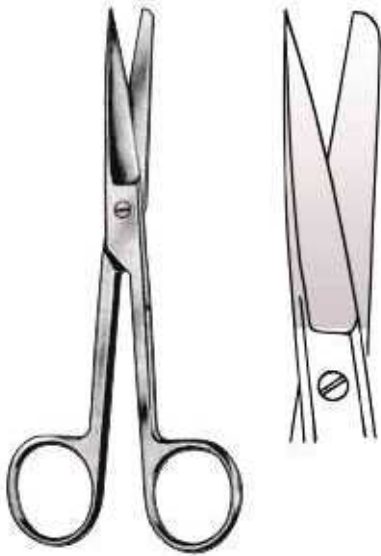

STANDARD STRAIGHT

- Z-15-049-115 11.5 cm, 4 1/2"
- Z-15-050-130 13.0 cm, 5"
- Z-15-051-140 14.0 cm, 5 1/2"
- Z-15-052-150 15.0 cm, 6"
- Z-15-053-160 16.0 cm, 6 1/4"
- Z-15-054-175 17.5 cm, 7"
- Z-15-055-185 18.5 cm, 7 1/4"
- Z-15-056-200 20.0 cm, 8"  
S/B Str.



STANDARD CURVED

- Z-15-057-115 11.5 cm, 4 1/2"
- Z-15-058-130 13.0 cm, 5"
- Z-15-059-140 14.0 cm, 5 1/2"
- Z-15-060-150 15.0 cm, 6"
- Z-15-061-165 16.0 cm, 6 1/4"
- Z-15-062-175 17.5 cm, 7"
- Z-15-063-185 18.5 cm, 7 1/4"
- Z-15-064-200 20.0 cm, 8"  
S/B Cvd.



STANDARD STRAIGHT

- Z-15-065-115 11.5 cm, 4 1/2"
- Z-15-066-130 13.0 cm, 5"
- Z-15-067-140 14.0 cm, 5 1/2"
- Z-15-068-150 15.0 cm, 6"
- Z-15-069-160 16.0 cm, 6 1/4"
- Z-15-070-175 17.5 cm, 7"
- Z-15-071-185 18.5 cm, 7 1/4"
- Z-15-072-200 20.0 cm, 8"  
S/S Str.



STANDARD CURVED

- Z-15-073-115 11.5 cm, 4 1/2"
- Z-15-074-130 13.0 cm, 5"
- Z-15-075-140 14.0 cm, 5 1/2"
- Z-15-076-150 15.0 cm, 6"
- Z-15-077-160 16.0 cm, 6 1/4"
- Z-15-078-175 17.5 cm, 7"
- Z-15-079-185 18.5 cm, 7 1/4"
- Z-15-080-200 20.0 cm, 8"  
S/S Cvd.



STANDARD STRAIGHT

- Z-15-081-115 11.5 cm, 4 1/2"
- Z-15-082-130 13.0 cm, 5"
- Z-15-083-140 14.0 cm, 5 1/2"
- Z-15-084-150 15.0 cm, 6"
- Z-15-085-160 16.0 cm, 6 1/4"
- Z-15-086-175 17.5 cm, 7"
- Z-15-087-185 18.5 cm, 7 1/4"
- Z-15-088-200 20.0 cm, 8"  
B/B Str.



STANDARD CURVED

- Z-15-089-115 11.5 cm, 4 1/2"
- Z-15-090-130 13.0 cm, 5"
- Z-15-091-140 14.0 cm, 5 1/2"
- Z-15-092-150 15.0 cm, 6"
- Z-15-093-160 16.0 cm, 6 1/4"
- Z-15-094-175 17.5 cm, 7"
- Z-15-095-185 18.5 cm, 7 1/4"
- Z-15-096-200 20.0 cm, 8"  
B/B Cvd.

**FINE PATTERN**



**GRAZIL STRAIGHT**  
Z-15-097-130 13.0 cm, 5"  
Z-15-098-145 14.5 cm, 5 3/4"  
S/S Str.



**GRAZIL CURVED**  
Z-15-099-130 13.0 cm, 5"  
Z-15-100-145 14.5 cm, 5 3/4"  
S/B Cvd.



**GRAZIL STRAIGHT**  
Z-15-101-130 13.0 cm, 5"  
Z-15-102-145 14.5 cm, 5 3/4"  
S/S Str.



**GRAZIL CURVED**  
Z-15-103-130 13.0 cm, 5"  
Z-15-104-145 14.5 cm, 5 3/4"  
S/S Cvd.



**GRAZIL STRAIGHT**  
Z-15-105-130 13.0 cm, 5"  
Z-15-106-145 14.5 cm, 5 3/4"  
B/B Str.



**GRAZIL CURVED**  
Z-15-107-130 13.0 cm, 5"  
Z-15-108-145 14.5 cm, 5 3/4"  
B/B Cvd.

**OPERATING, DISSECTING SCISSORS**

Chirurgische scheren, Präparierscheren  
Tijeras quirúrgicas, Tijeras de disección

Ciseaux chirurgicaux, Ciseaux à dissection  
Forbici per chirurgia, Forbici per dissezione



**DEAVER**  
Z-15-109-140  
14.0 cm, 5 ½"

**DEAVER**  
Z-15-110-140  
14.0 cm, 5 ½"

**MIXTER**  
Z-15-111-155  
15.5 cm, 6"

**MIXTER**  
Z-15-112-155  
15.5 cm, 6"

**JORGENSEN**  
Z-15-113-220  
22 cm, 8 ½"  
Curved



**INCISION SCISSORS**  
Z-15-114-130 13.0 cm, 5"  
Z-15-115-145 14.5 cm, 5 ½"

**INCISION SCISSORS**  
Z-15-116-155  
15.5 cm, 6"

**RICHTER**  
Z-15-117-145  
14.5 cm, 5 ½"

**FERGUSSON**  
Z-15-118-140 14.0 cm, 5 ½"  
Z-15-119-165 16.5 cm, 6 ½"  
Z-15-120-180 18.0 cm, 7"



Präparierscheren, Gynäkologische Scheren  
Tijeras de disección, Tijeras para ginecología

Ciseaux à dissection, ciseaux à gynécologie  
Forbici per dissezione, Forbici per ginecologia



**MAYO-STILLE**

Z-15-121-150 15.0 cm, 6"  
Z-15-122-170 17.0 cm, 6 3/4"  
Str.

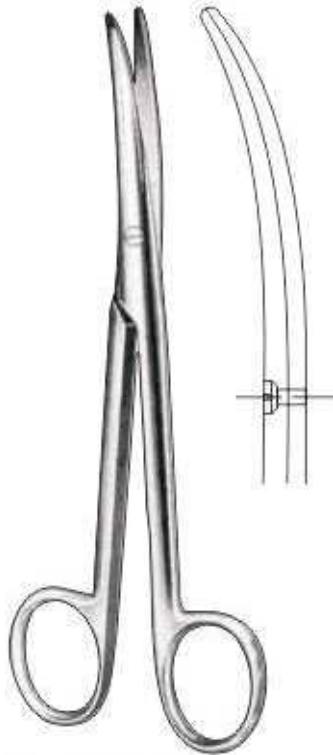

**MAYO-STILLE**

Z-15-123-150 15.0 cm, 6"  
Z-15-124-170 17.0 cm, 6 3/4"  
Cvd.

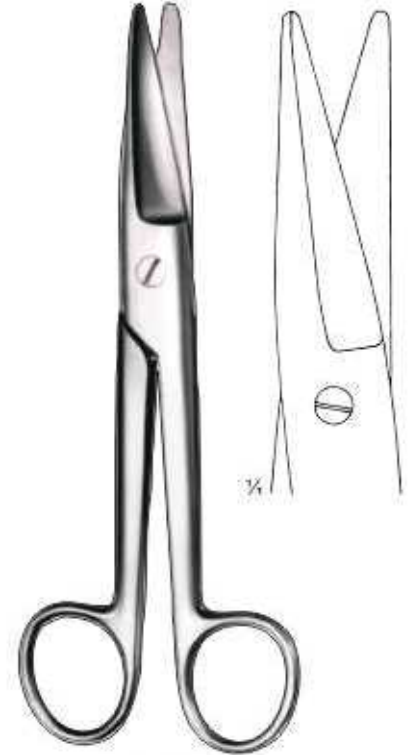

**MAYO-NOBLE**

Z-15-125-170  
17.0 cm, 6 3/4"  
Str.

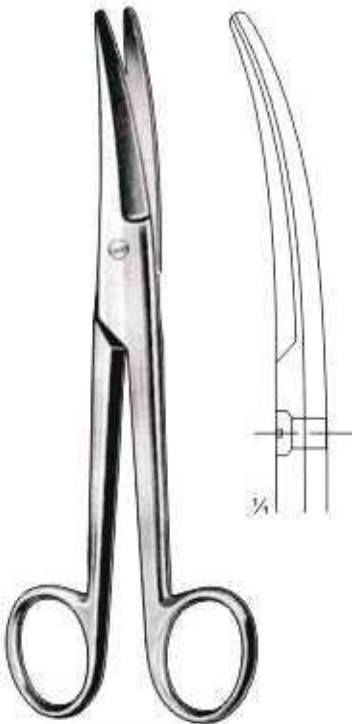

**MAYO-NOBLE**

Z-15-126-170  
17.0 cm, 6 3/4"  
Cvd.



**MAYO** Str.

Z-15-127-145 14.5 cm, 5 1/2"  
Z-15-128-150 15.0 cm, 6"  
Z-15-129-170 17.0 cm, 6 3/4"

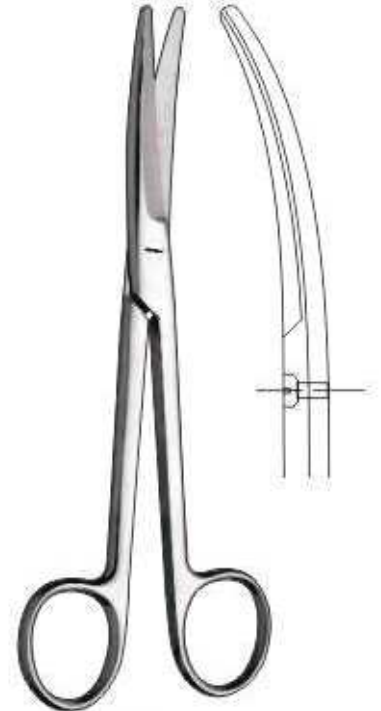

**MAYO** Cvd.

15-130-145 14.5 cm, 5 1/2"  
15-131-150 15.0 cm, 6"  
15-132-170 17.0 cm, 6 3/4"

Chirurgische scheren, Präparierscheren  
Tijeras quirúrgicas, Tijeras de disección

Ciseaux chirurgicaux, Ciseaux à dissection  
Forbici per chirurgia, Forbici per dissezione

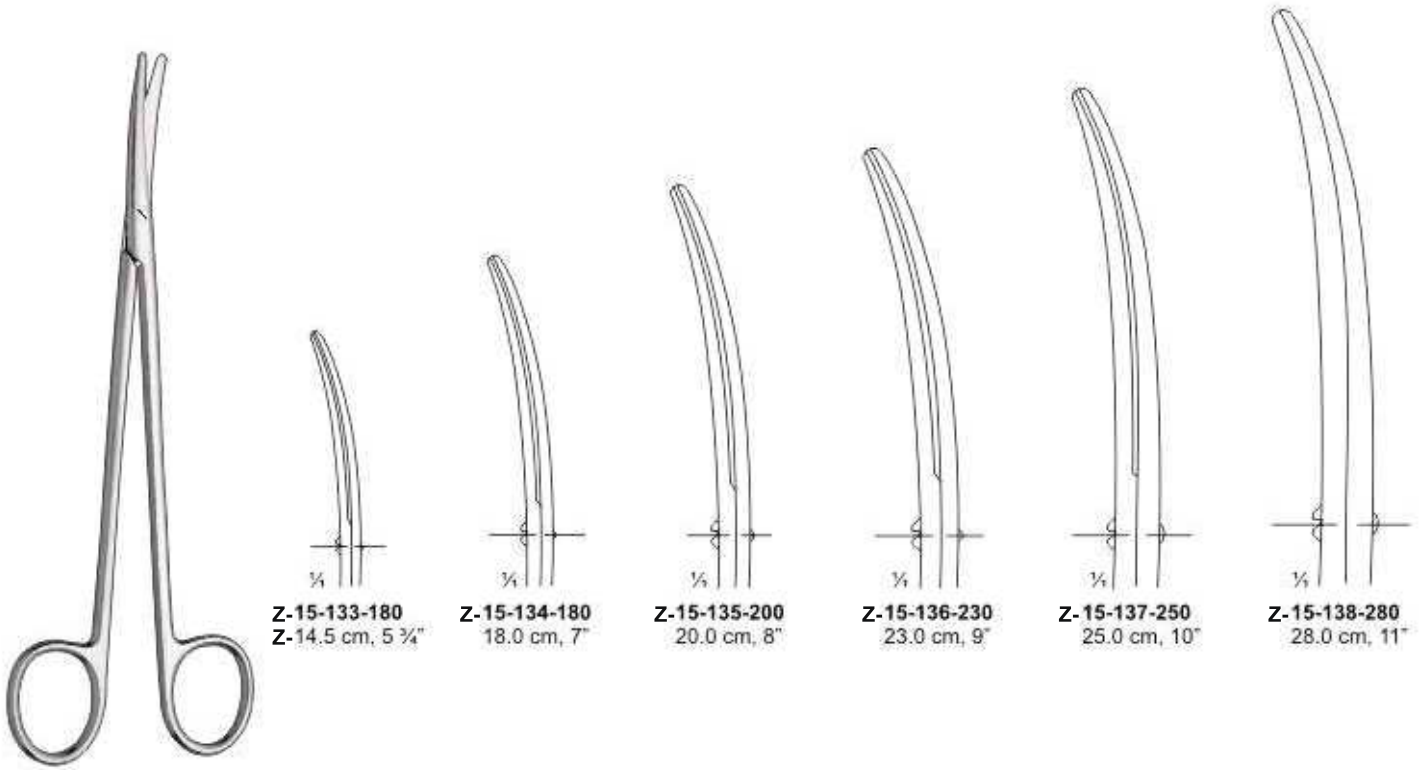

Z-15-133-180  
Z-14.5 cm, 5 3/4"

Z-15-134-180  
18.0 cm, 7"

Z-15-135-200  
20.0 cm, 8"

Z-15-136-230  
23.0 cm, 9"

Z-15-137-250  
25.0 cm, 10"

Z-15-138-280  
28.0 cm, 11"

**METZENBAUM**  
Blunt / Blunt

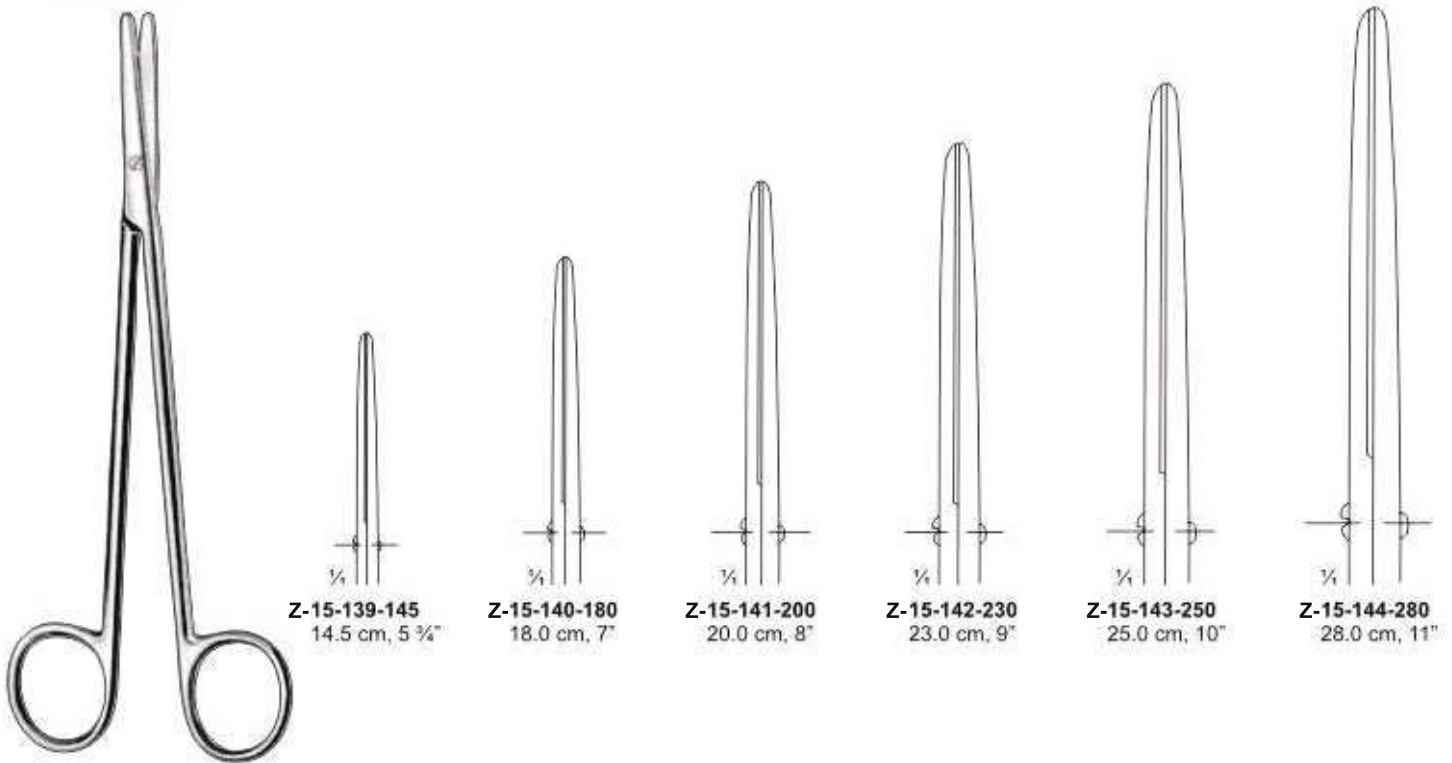

Z-15-139-145  
14.5 cm, 5 3/4"

Z-15-140-180  
18.0 cm, 7"

Z-15-141-200  
20.0 cm, 8"

Z-15-142-230  
23.0 cm, 9"

Z-15-143-250  
25.0 cm, 10"

Z-15-144-280  
28.0 cm, 11"

**METZENBAUM**  
Blunt / Blunt



Blade length  
6.4 cm  
5.1 cm  
4.4 cm

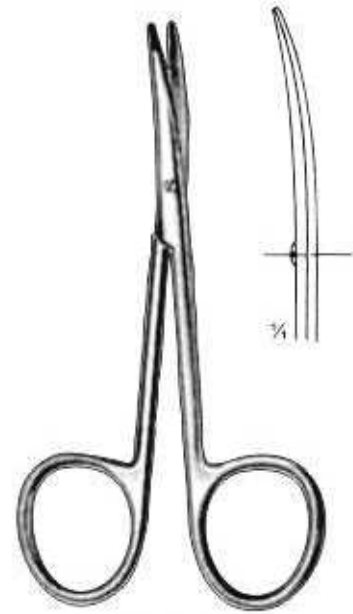

**METZENBAUM DISSECTING**

- Z-15-145-203 20.3 cm, 8"
- Z-15-146-229 22.9 cm, 9"
- Z-15-147-284 28.4 cm, 11"

Curved

**METZENBAUM-JAMISON**

- Z-15-148-152 15.25 cm, 6"

**METZENBAUM-BABY**

- Z-15-149-115 11.5 cm, 4 1/2"

**METZENBAUM-BABY**

- Z-15-150-115 11.5 cm, 4 1/2"

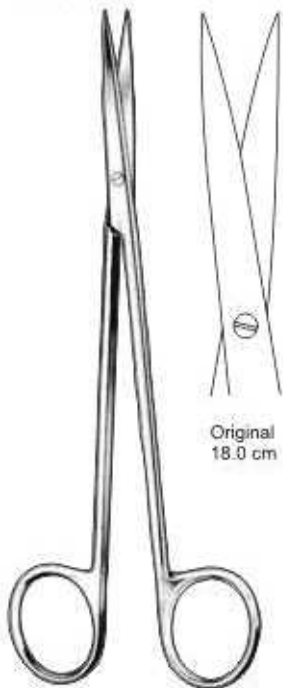

Original  
18.0 cm

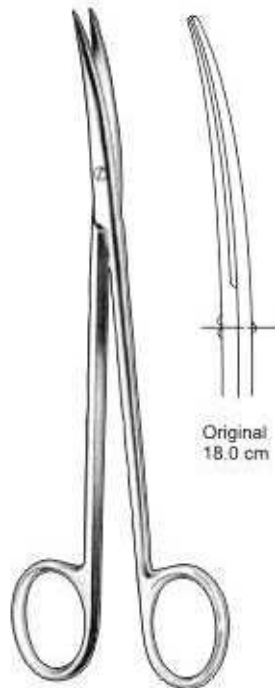

Original  
18.0 cm

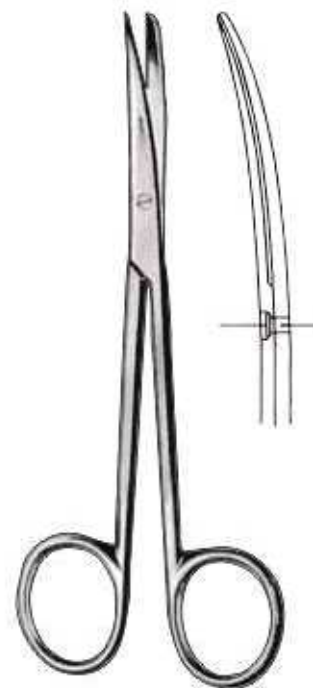

**METZENBAUM**  
Sharp/Sharp, Str.

- Z-15-151-145 14.5 cm, 5 1/2"
- Z-15-152-180 18.0 cm, 7"
- Z-15-153-200 20.0 cm, 8"
- Z-15-154-230 23.0 cm, 9"
- Z-15-155-250 25.0 cm, 10"
- Z-15-156-280 28.0 cm, 11"
- Z-15-157-300 30.0 cm, 12"

**METZENBAUM**  
Sharp/Sharp, Cvd.

- Z-15-158-145 14.5 cm, 5 1/2"
- Z-15-159-180 18.0 cm, 7"
- Z-15-160-200 20.0 cm, 8"
- Z-15-161-230 23.0 cm, 9"
- Z-15-162-250 25.0 cm, 10"
- Z-15-163-280 28.0 cm, 11"
- Z-15-164-300 30.0 cm, 12"

**METZENBAUM**  
Sharp/Blunt, Str.

- Z-15-165-145 14.5 cm, 5 1/2"
- Z-15-166-180 18.0 cm, 7"
- Z-15-167-200 20.0 cm, 8"
- Z-15-168-230 23.0 cm, 9"
- Z-15-169-250 25.0 cm, 10"
- Z-15-170-280 28.0 cm, 11"
- Z-15-171-300 30.0 cm, 12"

**METZENBAUM**  
Sharp/Blunt, Cvd.

- Z-15-172-145 14.5 cm, 5 1/2"
- Z-15-173-180 18.0 cm, 7"
- Z-15-174-200 20.0 cm, 8"
- Z-15-175-230 23.0 cm, 9"
- Z-15-176-250 25.0 cm, 10"
- Z-15-177-280 28.0 cm, 11"
- Z-15-178-300 30.0 cm, 12"

FACE-LIFE, DISSECTING, NASAL SCISSORS

Face-lift, Präparierscheren, Nasenscheren  
face-Lift, Tijeras de disección, Tijeras nasales

Face-lift, Ciseaux à dissection, Ciseaux nasaux  
Face-lift, Forbici per dissezione, Forbici nasali

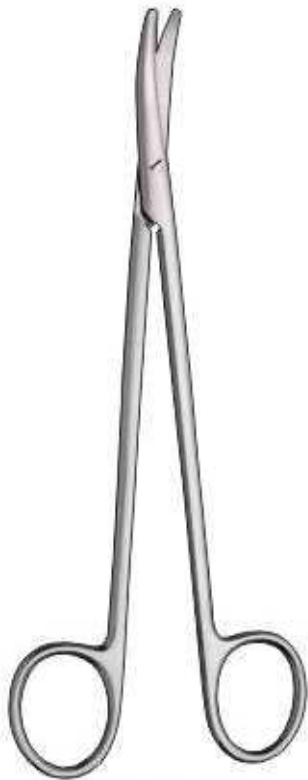

**THOREK-FELDMAN**  
Gall Bladder Scissor  
Z-15-179-180  
18.0 cm, 7"

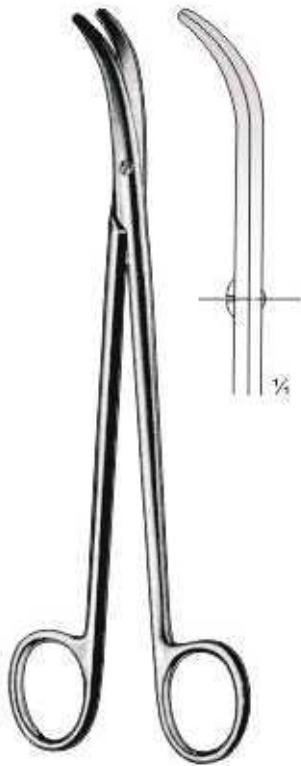

**THOREK**  
Z-15-180-190  
19.0 cm, 7 1/2"



**LEXER-BABY**  
Z-15-181-100  
10.0 cm, 4"

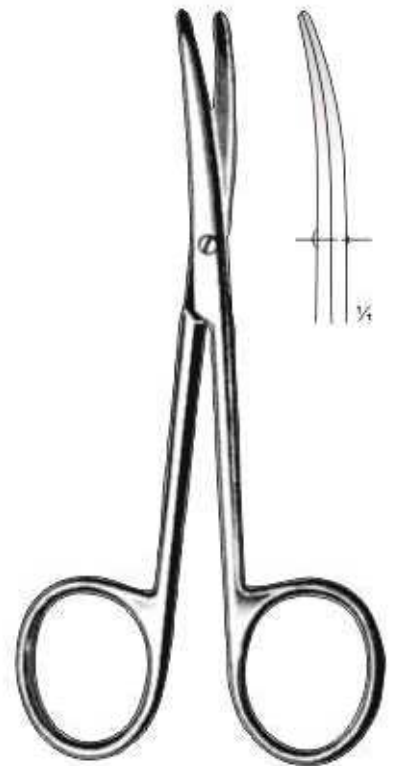

**LEXER-BABY**  
Z-15-182-100  
10.0 cm, 4"

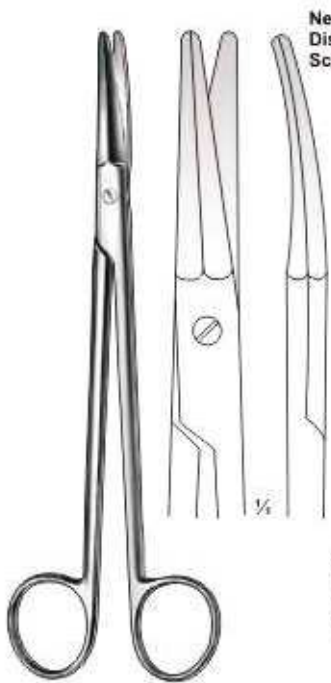

**KAYE FACE-LIFT  
SCISSORS**  
Z-15-183-185  
18.5 cm, 7 1/4"

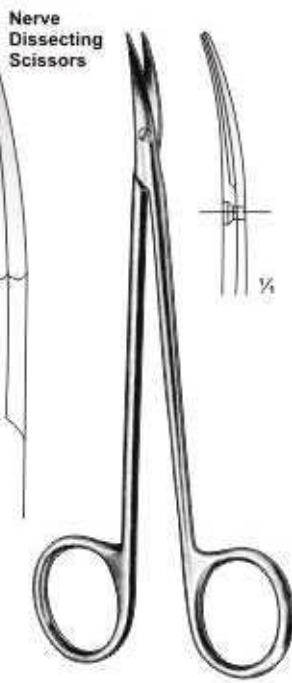

**Nerve Dissecting Scissors**  
Straight Z-15-184-150 15.0 cm, 6"  
Curved Z-15-185-150 15.0 cm, 6"



**LEXER**  
Z-15-186-160  
16.0 cm, 6 1/4"

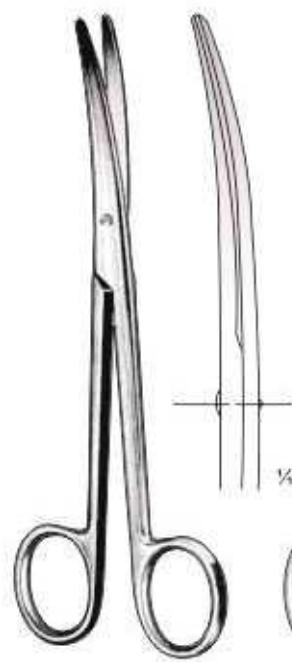

**LEXER**  
Z-15-187-160  
16.0 cm, 6 1/4"



**FOMON**  
Z-15-188-135  
13.5 cm, 5 1/4"

Chirurgische scheren, Präparierscheren  
Tijeras quirúrgicas, Tijeras de disección

Ciseaux chirurgicaux, Ciseaux à dissection  
Forbici per chirurgia, Forbici per dissezione



Plastic

**KILNER**  
Z-15-189-120 12.0 cm, 4 3/4"  
Z-15-190-150 15.0 cm, 6"  
Z-15-191-180 18.0 cm, 7"  
Z-15-192-200 20.0 cm, 8"  
Str.

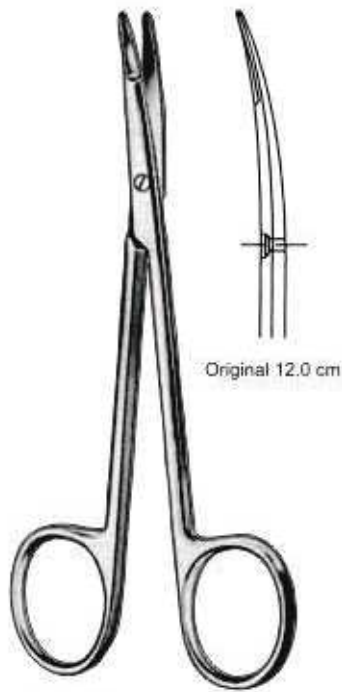

Original 12.0 cm

**KILNER**  
Z-15-193-120 12.0 cm, 4 3/4"  
Z-15-194-150 15.0 cm, 6"  
Z-15-195-180 18.0 cm, 7"  
Z-15-196-200 20.0 cm, 8"  
Cvd.



**REYNOLDS**  
Z-15-197-150 15.0 cm, 6"  
Z-15-198-180 18.0 cm, 7"  
Str.

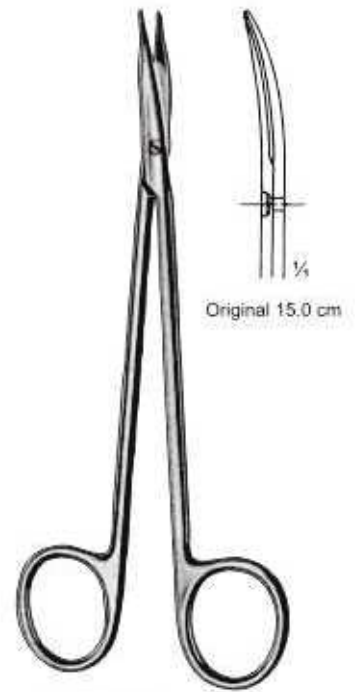

Original 15.0 cm

**REYNOLDS**  
Z-15-199-150 15.0 cm, 6"  
Z-15-200-180 18.0 cm, 7"  
Cvd.



**SANVENERO**  
Z-15-201-140  
14.0 cm, 5 1/2"  
Str.

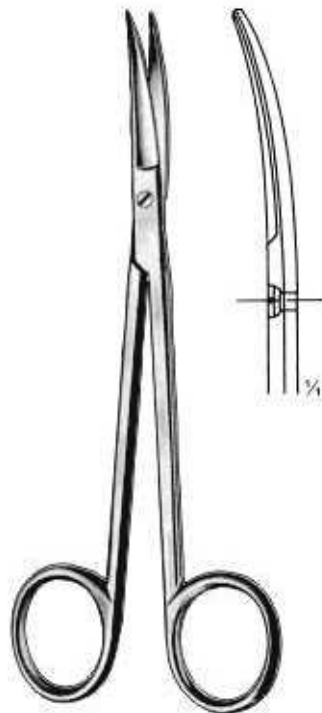

**SANVENERO**  
Z-15-202-140  
14.0 cm, 5 1/2"  
Cvd.



**JOSEPH**  
Z-15-203-140  
14.0 cm, 5 1/2"  
Str.

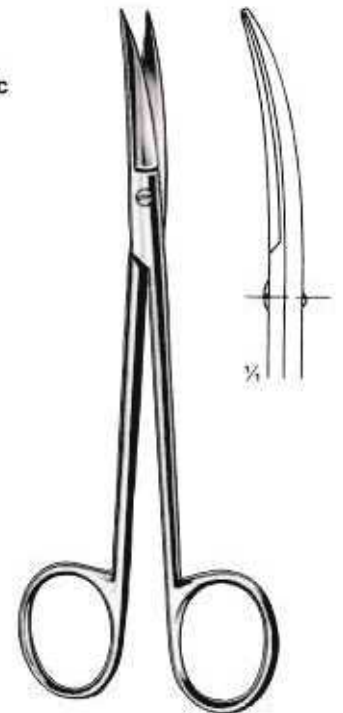

Plastic

**JOSEPH**  
Z-15-204-140  
14.0 cm, 5 1/2"  
Cvd.

**OPERATING, DISSECTING SCISSORS**

Chirurgische scheren, Präparierscheren  
Tijeras quirúrgicas, Tijeras de disección

Ciseaux chirurgicaux, Ciseaux à dissection  
Forbici per chirurgia, Forbici per dissezione



**KELLY**  
Z-15-205-160 16.0 cm, 6 ¼"  
Z-15-206-180 18.0 cm, 7"  
Str.

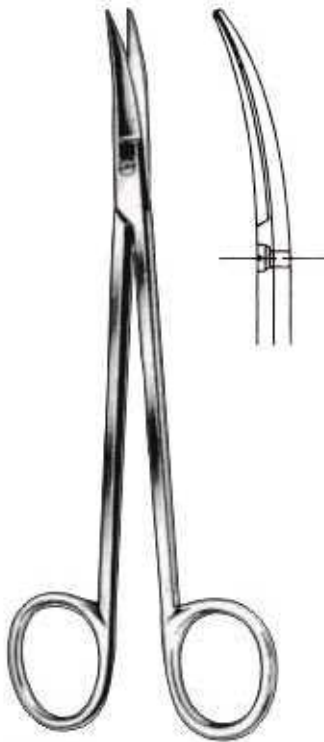

**KELLY**  
Z-15-207-160 16.0 cm, 6 ¼"  
Z-15-208-180 18.0 cm, 7"  
Cvd.



**VEZIEN**  
Z-15-209-180  
Z-18.0 cm, 7"

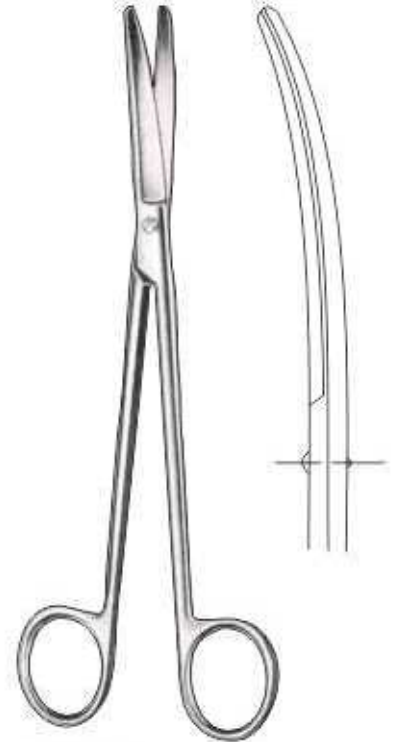

**WETHEIM**  
Z-15-210-145 14.5 cm, 5 ¾"  
Z-15-211-195 19.5 cm, 7 ¾"  
Z-15-212-225 22.5 cm, 8 ¾"



**DOYEN**  
Z-15-213-160  
16.0 cm, 6 ¼"  
S/B, Str.

**DOYEN**  
Z-15-214-160  
16.0 cm, 6 ¼"  
B/B, Str.

**DOYEN**  
Z-15-215-160  
16.0 cm, 6 ¼"  
B/B, Cvd.

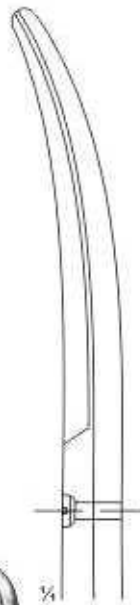

**DOYEN**  
Z-15-216-175  
17.5 cm, 6 ¾"  
B/B, Str.



**DOYEN**  
Z-15-217-175  
17.5 cm, 6 ¾"  
B/B, Cvd.

Präparierscheren, Gynäkologische Scheren  
Tijeras de disección, Tijeras para ginecología

Ciseaux à dissection, ciseaux à gynécologie  
Forbici per dissezione, Forbici per ginecologia



**DUBOIS**  
Z-15-218-270  
27.0 cm, 10 1/4"

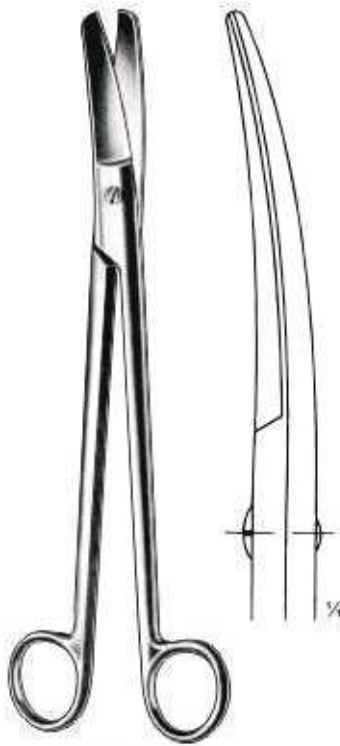

**DUBOIS**  
Z-15-219-270  
27.0 cm, 10 3/4"

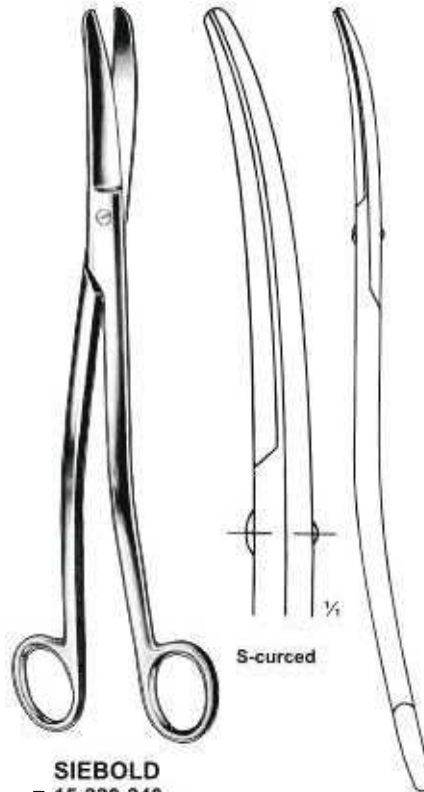

**SIEBOLD**  
Z-15-220-240  
24.0 cm, 9 1/2"



**CARDINALE**  
Z-15-221-280  
28.0 cm, 11"



**SIMS**  
Z-15-222-200 20.0 cm, 8"  
Z-15-223-230 23.0 cm, 9"  
Straight, B/B



Z-15-224-200  
20.0 cm, 8"  
Z-15-225-230  
23.0 cm, 9"  
S/B



Z-15-226-200  
20.0 cm, 8"  
Z-15-227-230  
23.0 cm, 9"  
S/S



**SIMS**  
Z-15-228-200 20.0 cm, 8"  
Z-15-229-230 23.0 cm, 9"  
Curved, B/B



Z-15-230-200  
20.0 cm, 8"  
Z-15-231-230  
23.0 cm, 9"  
S/B



Z-15-232-200  
20.0 cm, 8"  
Z-15-233-230  
23.0 cm, 9"  
S/S

Scisschen, Schnenscheren  
Tijeras para Iridectomia, Tijeras para tendones

**IRIS, TENDON SCISSORS** **ZIANA**  
Ciseaux à iridectomie, Ciseaux à Ténotomie  
Forbici per iridectomia, Forbici per tenotomia **INDUSTRIES**

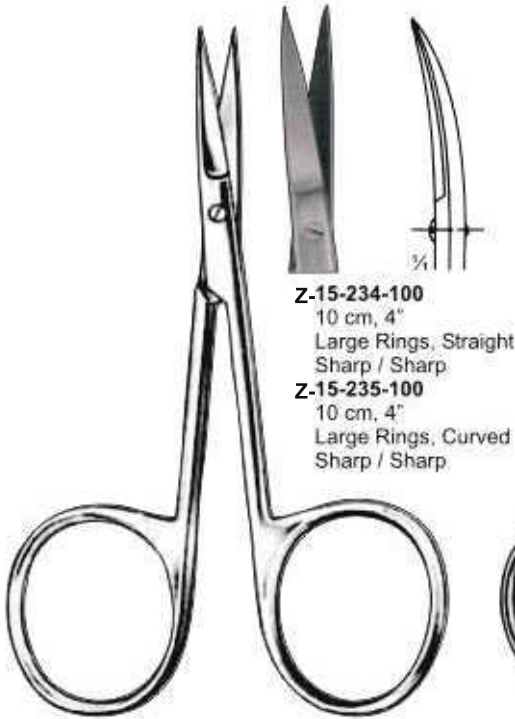

**Z-15-234-100**  
10 cm, 4"  
Large Rings, Straight  
Sharp / Sharp  
**Z-15-235-100**  
10 cm, 4"  
Large Rings, Curved  
Sharp / Sharp

IRIS

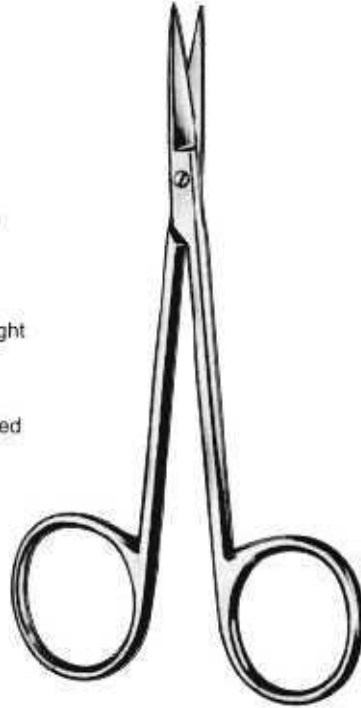

IRIS SCISSORS

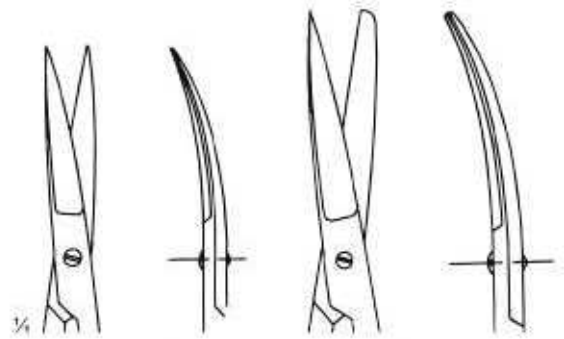

Item	Description	Tip
15-236-090	09 cm, 3 1/2" Straight	Sharp/Sharp
15-237-105	10.5 cm, 4 1/4" Straight	Sharp/Sharp
15-238-115	11.5 cm, 4 1/2" Straight	Sharp/Sharp
15-239-120	12.0 cm, 4 3/4" Straight	Sharp/Sharp
15-240-090	09 cm, 3 1/2" Curved	Sharp/Blunt
15-241-105	10.5 cm, 4 1/4" Curved	Sharp/Blunt
15-242-115	11.5 cm, 4 1/2" Curved	Sharp/Blunt
15-243-120	12.0 cm, 4 3/4" Curved	Sharp/Blunt

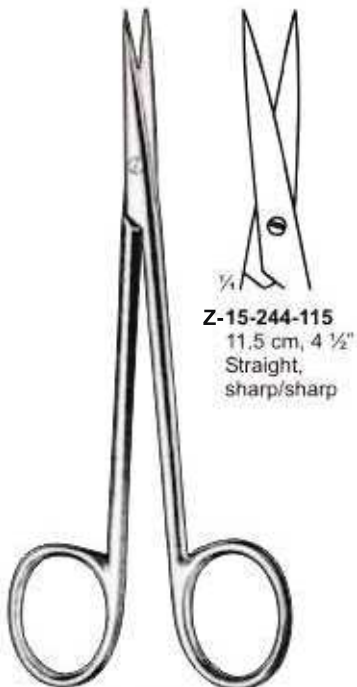

**Z-15-244-115**  
11.5 cm, 4 1/2"  
Straight,  
sharp/sharp

KILLNER

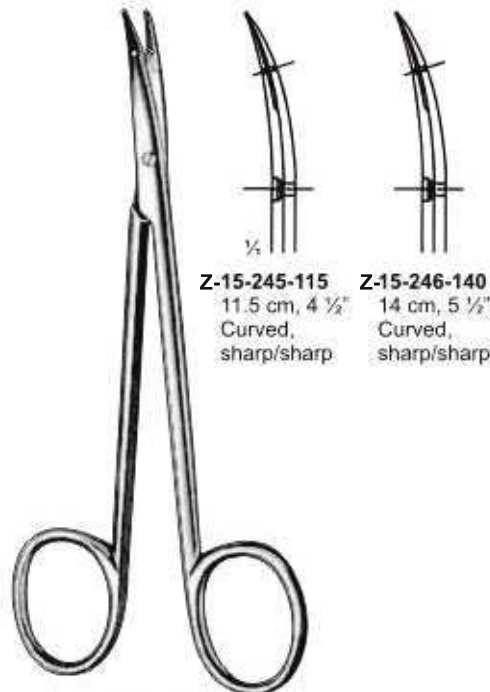

**Z-15-245-115**  
11.5 cm, 4 1/2"  
Curved,  
sharp/sharp

**Z-15-246-140**  
14 cm, 5 1/2"  
Curved,  
sharp/sharp

LITTLER

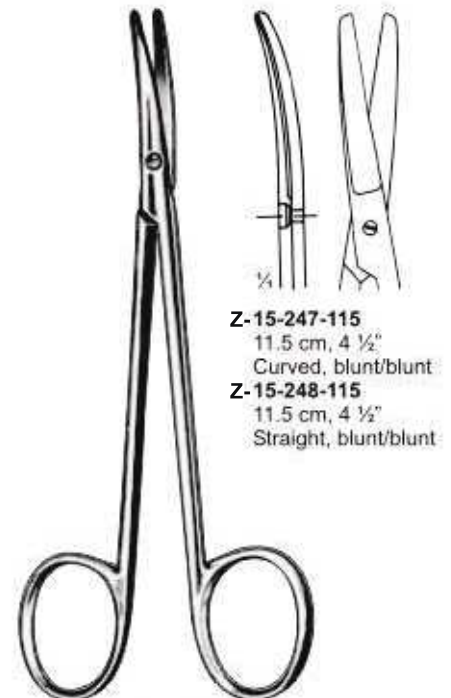

**Z-15-247-115**  
11.5 cm, 4 1/2"  
Curved, blunt/blunt

**Z-15-248-115**  
11.5 cm, 4 1/2"  
Straight, blunt/blunt

STRABISMUS





**IRIS ANGULAR**  
Z-15-249-114  
11.4 cm, 4 1/2"



**IRIS**  
Z-15-250-115  
11.5 cm, 4 1/2"



**POTTS-REYNOLDS  
TENOTOMY**  
Z-15-251-120  
12.0 cm, 4 1/4"  
Curved



**POTTS TENOTOMY**  
Z-15-252-152 15.2 cm, 6"  
Z-15-253-178 17.8 cm, 7"  
Z-15-254-203 20.3 cm, 8"

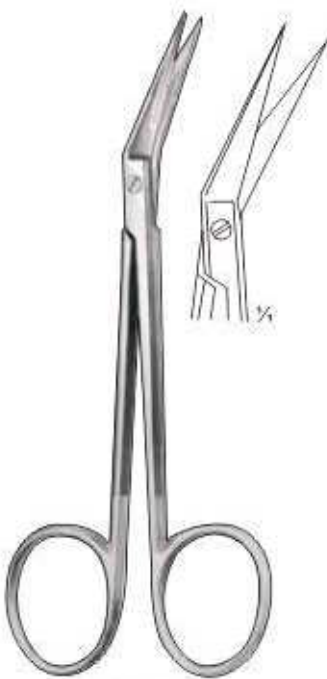

**IRIS ANGULAR**  
Z-15-255-110  
11cm 4 1/4"



**KNAPP IRIS**  
Z-15-256-102 Straight,  
15-257-102 Curved  
10.2 cm, 4"



**WILMER IRIS**  
Z-15-258-089  
8.9 cm, 3 1/2"

Präparierscheren  
 Tijeras de disección

Ciseaux à dissection  
 Forbici per dissezione

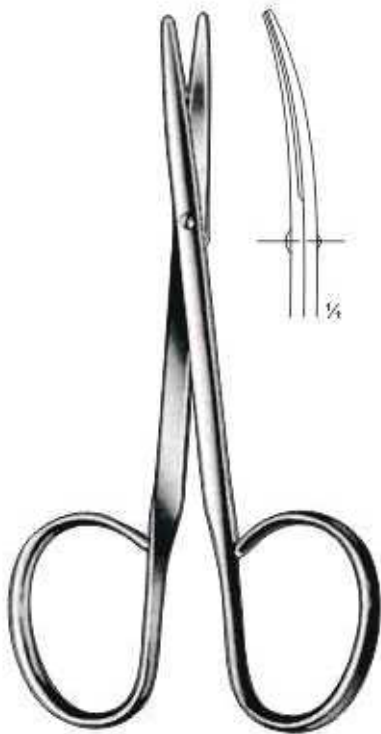

**Z-15-259-100**  
 10.0 cm, 4"  
 Straight

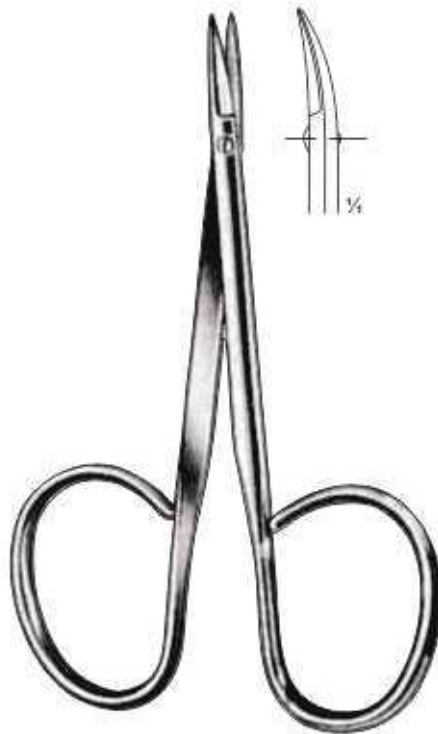

**Z-15-260-100**  
 10.0 cm, 4"  
 Curved



**Z-15-261-095**  
 9.5 cm, 3 3/4"  
 Straight

**Z-15-262-095**  
 9.5 cm, 3 3/4"  
 Curved

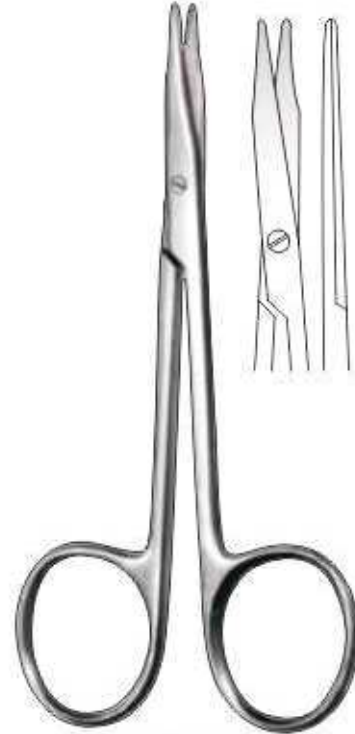

**TENOTOMY-STEVENS**  
**Z-15-263-110** Straight  
**Z-15-264-110** Curved  
 11 cm, 4 1/4"

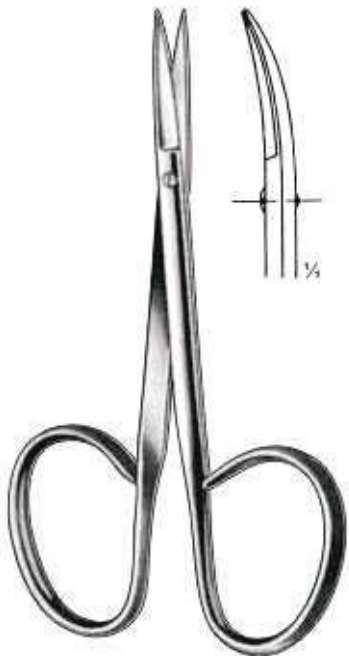
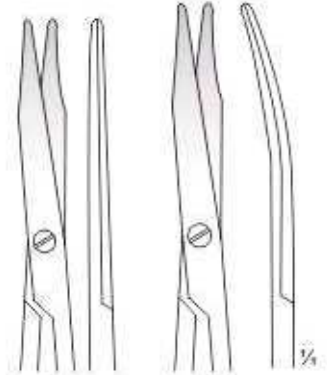

**Z-15-265-100**  
 10.0 cm, 4"  
 Straight



**Z-15-266-100**  
 10.0 cm, 4"  
 Curved



**Z-15-267-100**  
 10.0 cm, 4"  
 Straight

**Z-15-268-100**  
 10.0 cm, 4"  
 Curved

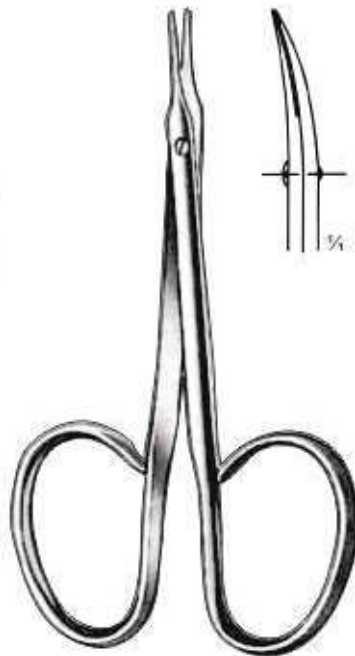

**TENOTOMY**  
**Z-15-269-095**  
 9.5 cm, 3 3/4"  
 Curved-Ribbon  
 Handles blunt/blunt

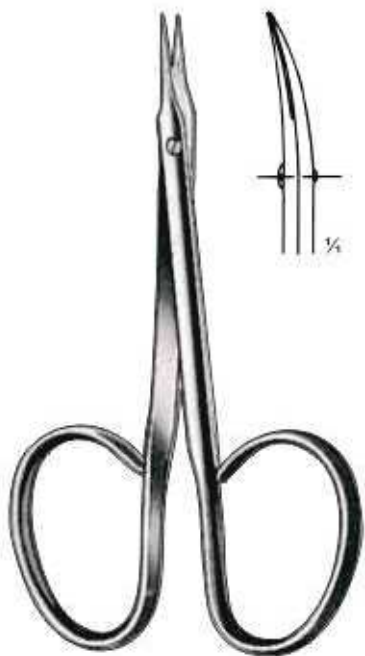

**Z-15-270-095**  
 9.5 cm, 3 3/4"  
 Straight



**Z-15-271-095**  
 9.5 cm, 3 3/4"  
 Curved

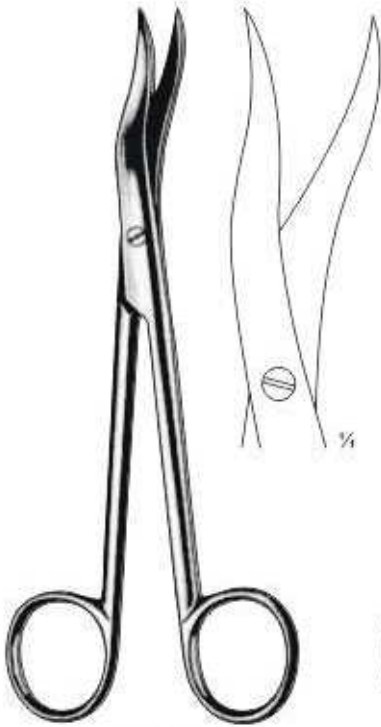

**Z-15-272-160**  
16.0 cm, 6 1/4"

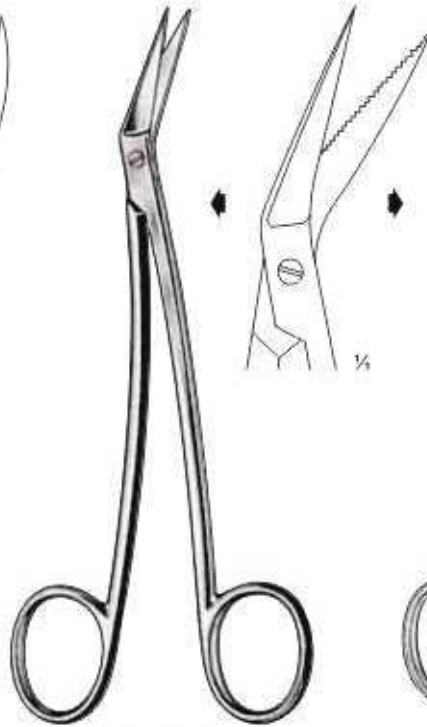

**LOCKLIN**  
**Z-15-273-165**  
16.5 cm, 6 1/2"



**LOCKLIN**  
**Z-15-274-165**  
16.5 cm, 6 1/2"

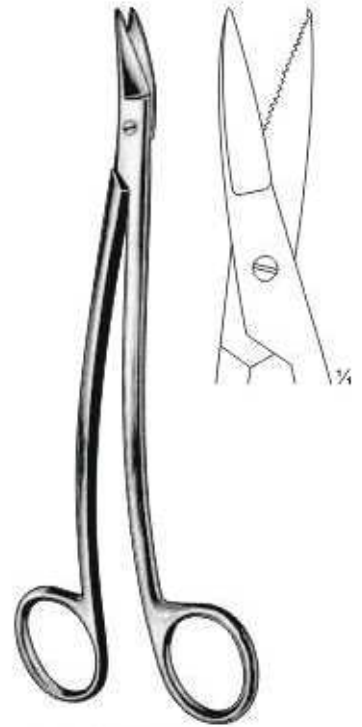

**DEAN-DELLICATE**  
**Z-15-275-170**  
17.0 cm, 6 3/4"

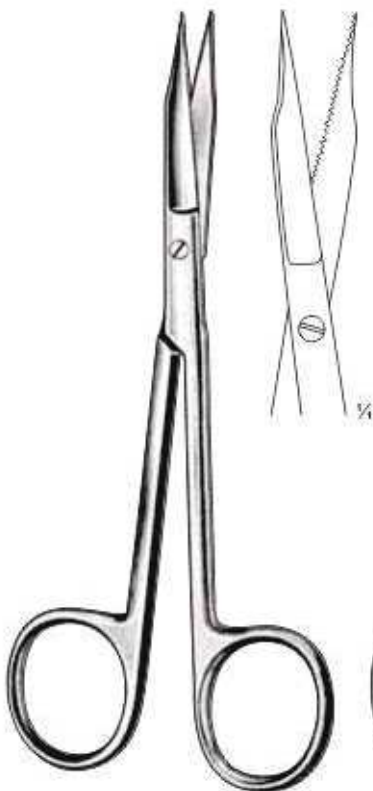

**GOLDMAN-FOX**  
**Z-15-276-130**  
13.0 cm, 5"

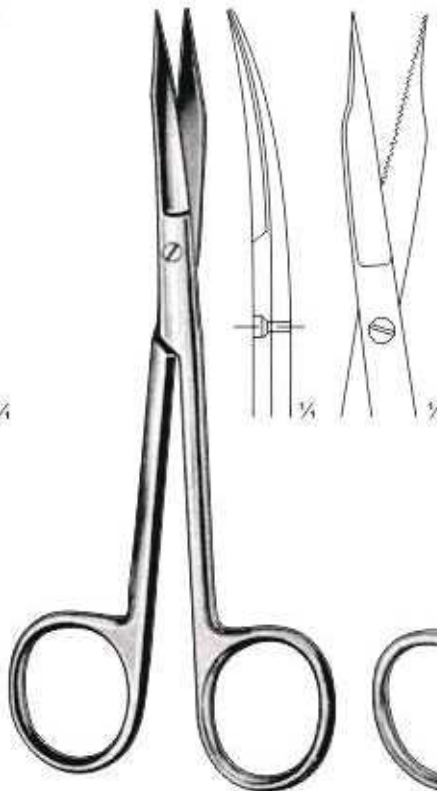

**GOLDMAN-FOX**  
**Z-15-277-130**  
13.0 cm, 5"

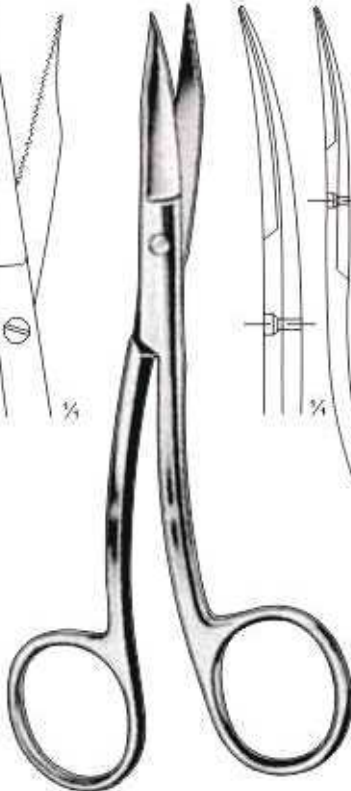

**GOLDMAN-FOX (Spezial)**  
**Z-15-278-130**  
13.0 cm, 5"

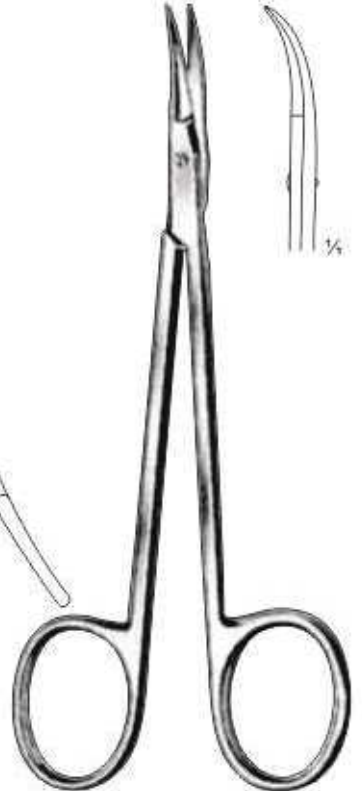

**Z-15-279-115**  
11.5 cm, 4 1/2"

Gefäßscheren  
Tijeras vasculares

Ciseaux vasculaires  
Forbici vascolari



Z-15-280-190  
19.0 cm, 7 1/2"

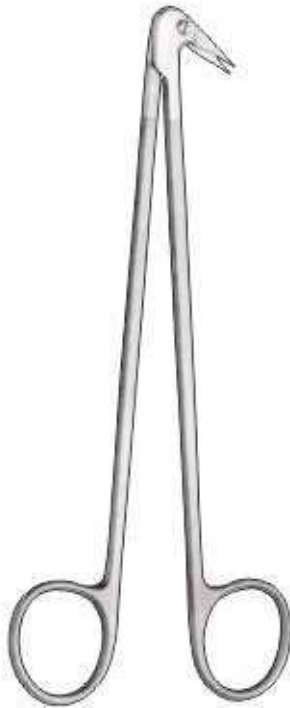

**COOLEY REVERSE  
Cut Scissors**  
Z-15-281-171  
angled 120°  
17.1 cm, 6 3/4"

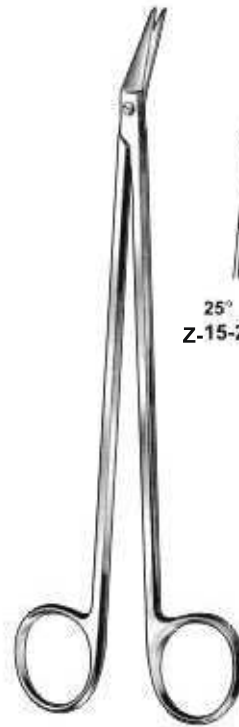

**POTTS-SMITH**  
19.0 cm, 7 1/2"

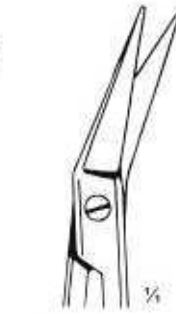

25°  
Z-15-282-190



45°  
Z-15-283-190



60°  
Z-15-284-190

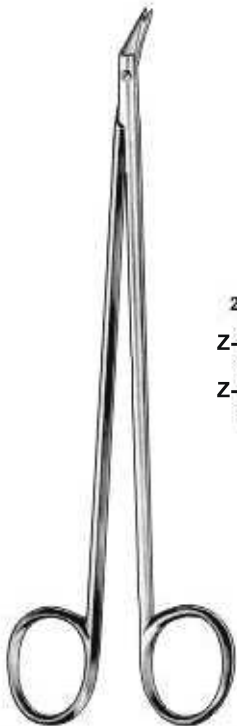

**HEGEMANN-DIETRICH**



25°  
Z-15-285-160  
16.0 cm, 6 1/4"

Z-15-286-190  
19.0 cm, 7 1/2"



45°  
Z-15-287-160  
16.0 cm, 6 1/4"

Z-15-288-190  
19.0 cm, 7 1/2"



60°  
Z-15-289-160  
16.0 cm, 6 1/4"

Z-15-290-190  
19.0 cm, 7 1/2"



90°  
Z-15-291-160  
16.0 cm, 6 1/4"

Z-15-292-190  
19.0 cm, 7 1/2"



125°  
Z-15-293-160  
16.0 cm, 6 1/4"

Z-15-294-190  
19.0 cm, 7 1/2"



**POTTS-DE MARTEL**  
Z-15-295-210  
21.0 cm, 8 1/4"



**MILLS**  
Z-15-296-210  
21.0 cm, 8 1/4"



**FULTON**  
Z-15-297-170  
17.0 cm, 6 3/4"



**POTTS-SMITH**  
Z-15-298-197  
19.7 cm, 8"  
angled on flat 50°



**POTTS-SMITH SCISSORS**  
Z-15-299-133  
Short,  
Angled 45°  
13.3 cm, 5 1/4"



**POTTS-SMITH SCISSORS**  
Z-15-300-146  
short blades  
angled 45°  
14.6 cm, 5 3/4"

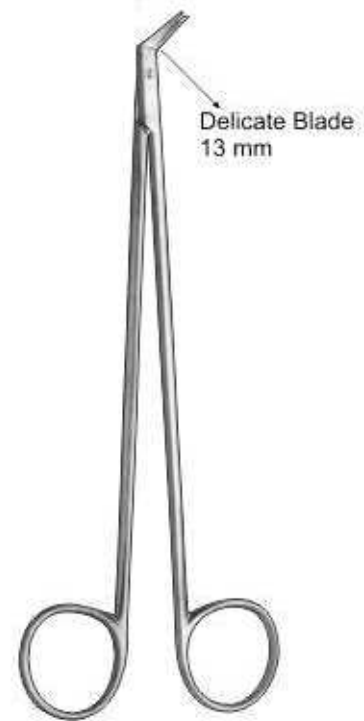

**POTTS-SMITH**  
Z-15-301-191 19.1 cm, 7 1/2" angled 25°  
Z-15-302-133 13.3 cm, 5 1/4" angled 45°  
Z-15-303-191 19.1 cm, 7 1/2" angled 45°  
Z-15-304-191 19.1 cm, 7 1/2" angled 60°  
Z-15-305-191 19.1 cm, 7 1/2" angled 90°

Gefäßscheren  
Tijeras vasculares

Ciseaux vasculaires  
Forbici vascolari

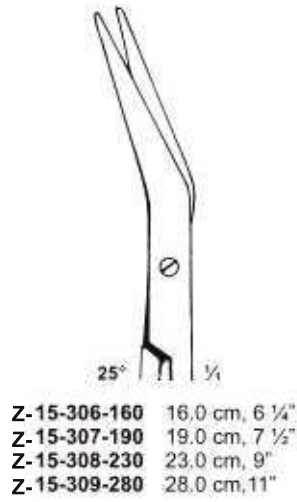

Z-15-306-160 16.0 cm, 6 1/4"  
Z-15-307-190 19.0 cm, 7 1/2"  
Z-15-308-230 23.0 cm, 9"  
Z-15-309-280 28.0 cm, 11"

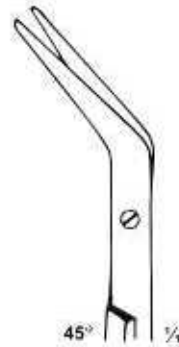

Z-15-310-160 16.0 cm, 6 1/4"  
Z-15-311-190 19.0 cm, 7 1/2"  
Z-15-312-230 23.0 cm, 9"  
Z-15-313-280 28.0 cm, 11"

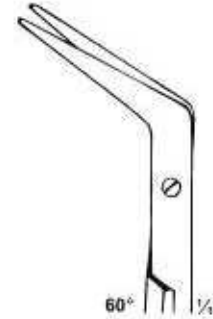

Z-15-314-160 16.0 cm, 6 1/4"  
Z-15-315-190 19.0 cm, 7 1/2"  
Z-15-316-230 23.0 cm, 9"  
Z-15-317-280 28.0 cm, 11"

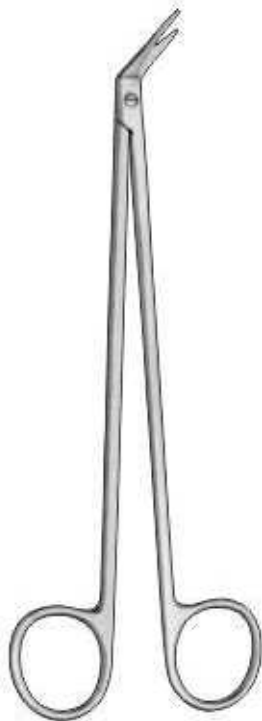

**COOLEY** Z-15-318-184  
angled 45° 1 mm probe point on tip.  
18.4 cm, 7 1/2" Z-15-319-184  
1.5 mm probe point on tip.



**O'BRIEN**  
Z-15-320-090  
9.0 cm, 3 1/2"

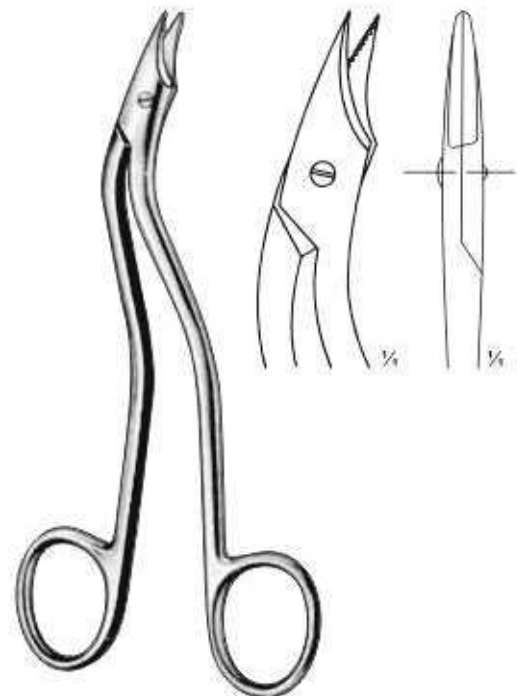

**HEATH**  
Z-15-321-150  
15.0 cm, 6"



**LITWIN ANGLED**  
Z-15-322-184  
18.4 cm, 7 1/4"  
Angled 45°

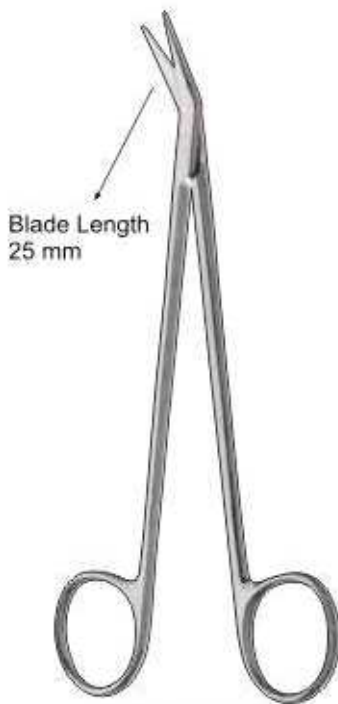

**DEBAKEY-POTTS**  
Z-15-323-165 angled 20°  
Z-15-324-165 angled 45°  
Z-15-325-165 angled 60°  
16.5 cm, 6 1/2"



**DEBAKEY VASCULAR**  
Z-15-326-229 angled 25°  
Z-15-327-229 angled 45°  
Z-15-328-229 angled 60°  
Z-15-329-229 angled 45°  
22.9 cm, 9"

Gefäßscheren  
 Tijeras vasculares

Ciseaux vasculaires  
 Forbici vascolari



**Z-15-330-105**  
 10.5 cm, 4"

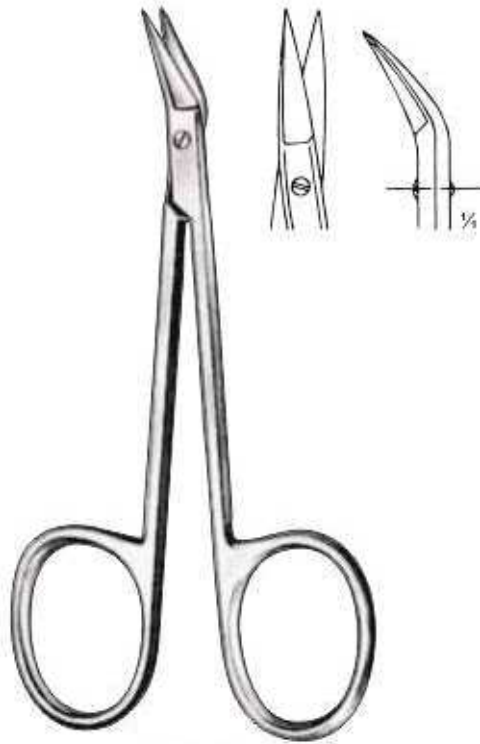

**Z-15-331-100**  
 10.0 cm, 4"

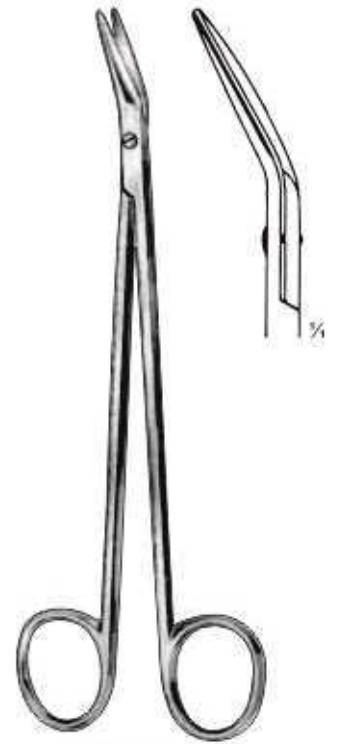

**CLASSON**  
**Z-15-332-170**  
 17.0 cm, 4"



**COOLEY ARTERIOTOMY**  
**Z-15-333-184** 18.4 cm, 7 1/4"  
**Z-15-334-229** 22.9 cm, 9"  
**Z-15-335-273** 27.3 cm, 11"



**SWEET ESOPHAGEAL**  
**Z-15-336-216**  
 21.6 cm, 8 1/2"

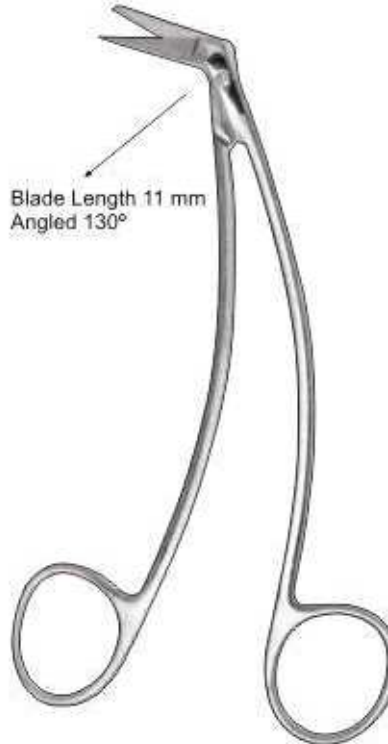

**FAVALORO  
 CORONARY**  
**Z-15-337-171**  
 17.1 cm, 6 3/4"



**Z-15-338-105**  
 10.5 cm, 4"  
 Angled 90°





**COOLEY CARDIOVASCULAR**

Z-15-339-191 19.1 cm, 7 1/2"  
Z-15-340-229 22.9 cm, 9"  
Curved



**CRAFORD LOBECTOMY**

Z-15-341-305  
30.5 cm, 12"  
curved



**NELSON LUNG  
DISSECTING**

Z-15-342-229 Straight  
Z-15-343-229 Curved  
22.9 cm, 9"



**FINOCHIETTO**

Z-15-344-270  
27.0 cm, 10 1/2"



**RESANO**

Z-15-345-250  
25.0 cm, 10"

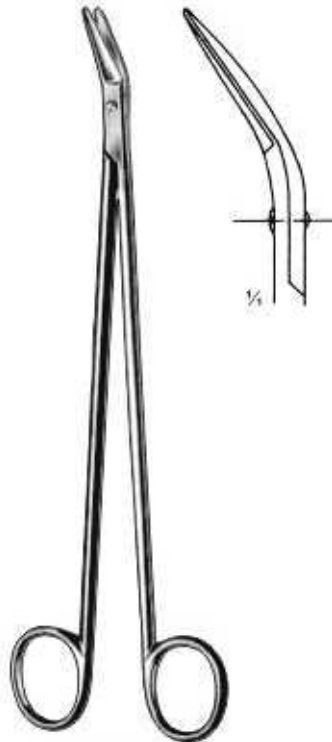

**POTTS-SMITH**

Z-15-346-195  
19.5 cm, 7 3/4"

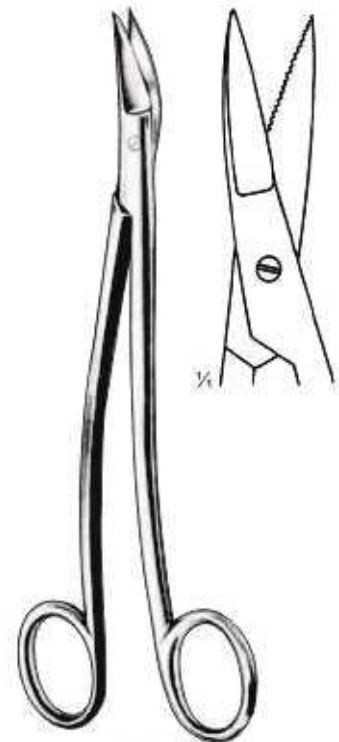

**ENT-DEAN**

Z-15-347-170  
17 cm, 6 3/4"  
Serrated

Gefäßscheren  
 Tijeras vasculares

Ciseaux vasculaires  
 Forbici vascolari



**CARDIOVASCULAR**  
**Z-15-348-121**  
 12.1 cm, 4 3/4"  
 curved



**MORSE SCISSORS**  
**Z-15-349-178**  
 17.8 cm, 7"  
 curved



**LITWAK GENERAL UTILITY**  
**Z-15-350-117**  
 11.7 cm, 4 3/4"



**MAYO-HARRINGTON DISSECTING**  
**Z-15-351-229** 22.9 cm, 9" Straight.  
**Z-15-352-279** 27.9 cm, 11" Straight.  
**Z-15-353-229** 22.9 cm, 9" Curved.  
**Z-15-354-279** 27.9 cm, 11" Curved.



**TOENIS DISSECTING**  
**Z-15-355-184** Straight  
 18.4 cm, 7 1/4"  
**Z-15-356-181** Curved.  
 18.1 cm, 7"  
 Delicate



**DEMARTEL VASCULAR**  
**Z-15-357-171** 17.1 cm, 6 3/4" Curved.  
**Z-15-358-197** 19.7 cm, 8" Straight.  
**Z-15-359-171** 17.1 cm, 6 3/4" Straight.



**DEBAKEY ENDARTERECTOMY**  
**Z-15-360-178**  
 17.8 cm, 7"  
 curved



**STRULLY**  
Z-15-361-220  
22.0 cm, 8 3/4"



**STRULLY**  
Z-15-362-220  
22.0 cm, 8 3/4"



**DANDY**  
Z-15-363-170  
17.0 cm, 6 3/4"

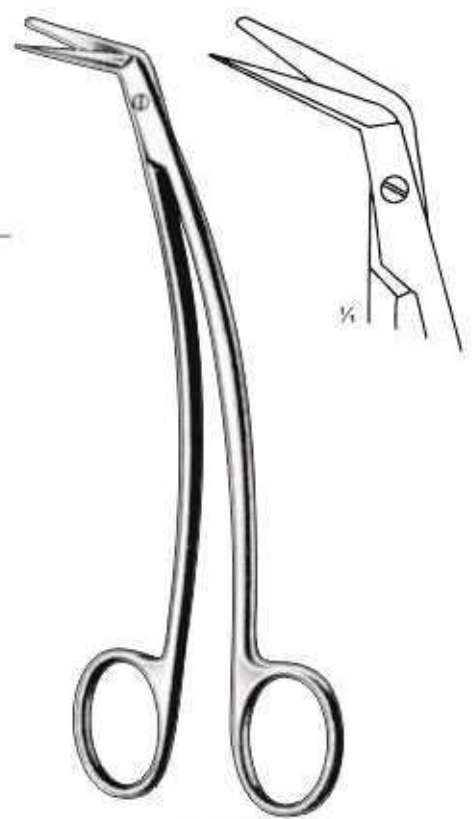

**FAVALORO**  
Z-15-364-150  
15.0 cm, 6"



**Z-15-365-115**  
11.5 cm, 4 1/2"



**Z-15-366-145**  
14.5 cm, 5 3/4"



**Z-15-367-145**  
14.5 cm, 5 3/4"



**NEUMANN**  
Z-15-368-125  
12.5 cm, 5"

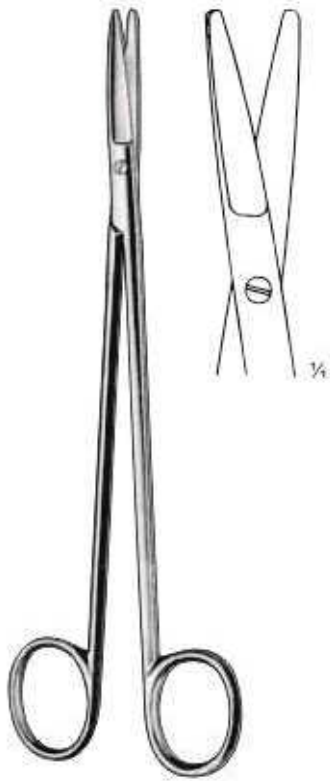

**TOENNIS**  
 Z-15-369-180  
 18.0 cm, 7"

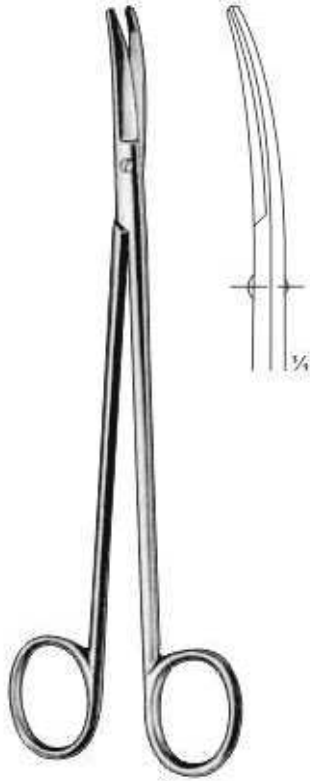

**TOENNIS**  
 Z-15-370-180  
 18.0 cm, 7"



**QUINBY**  
 Z-15-371-120  
 12.0 cm, 4 3/4"



**QUINBY**  
 15-372-120  
 12.0 cm, 4 3/4"

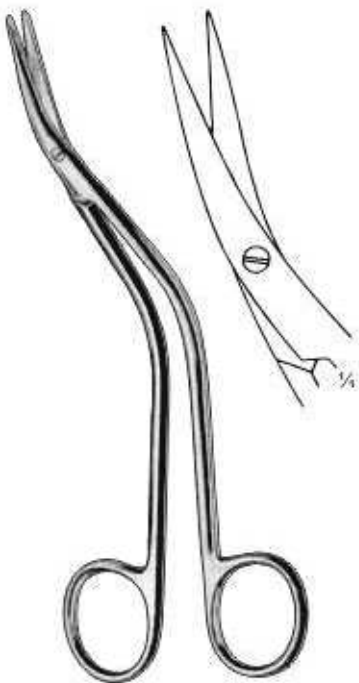

**DE BAKEY**  
 Z-15-373-155  
 15.5 cm, 6"

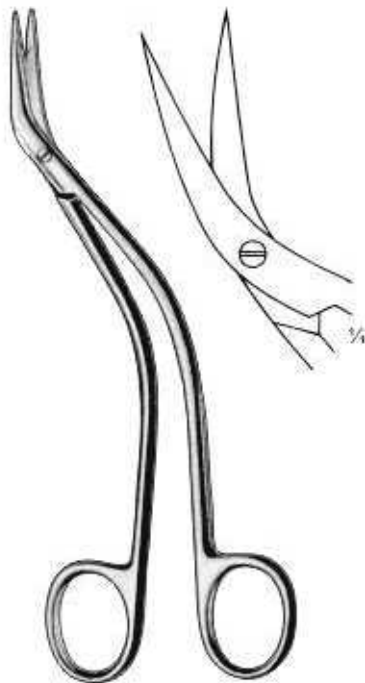

**DE BAKEY**  
 Z-15-374-155  
 15.5 cm, 6"



**SCHMIEDEN-TAYLOR**  
 Z-15-375-145 14.5 cm, 5 3/4"  
 Z-15-376-175 17.5 cm, 6 3/4"

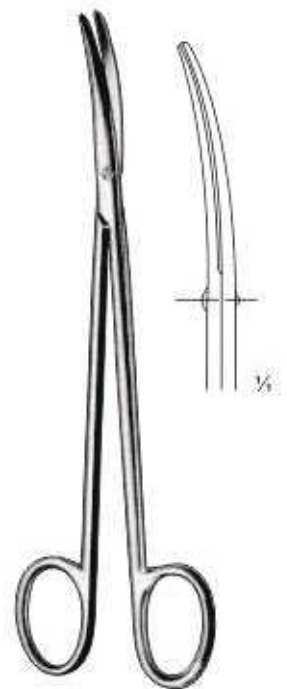

**TOENNIS-ADSON**  
 Z-15-377-175  
 17.5 cm, 6 3/4"

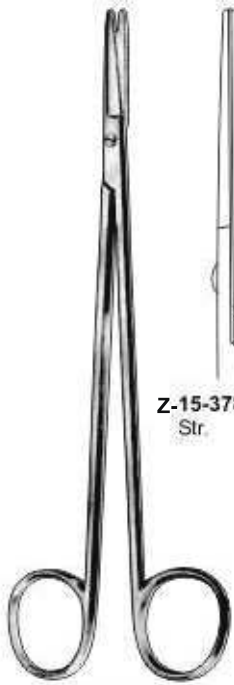

Z-15-378-170  
Str.

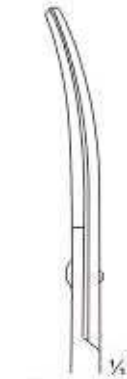

Z-15-379-170  
Cvd.

**CHURCH**  
17.0 cm, 6 3/4"

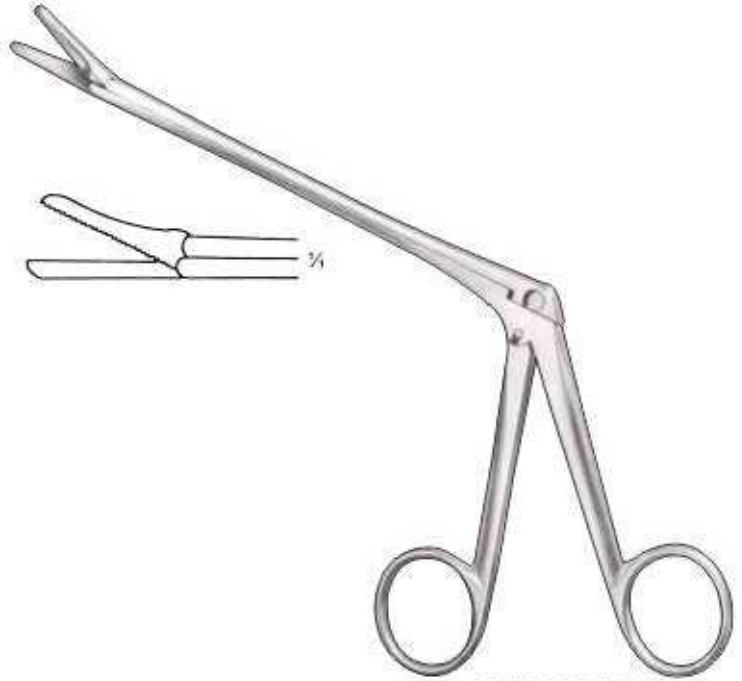

**OLIVECRONA**  
15-380-230  
23.0 cm, 9"



**KLINKENBERGH-LOTH**  
Z-15-381-230  
23.0 cm, 9"

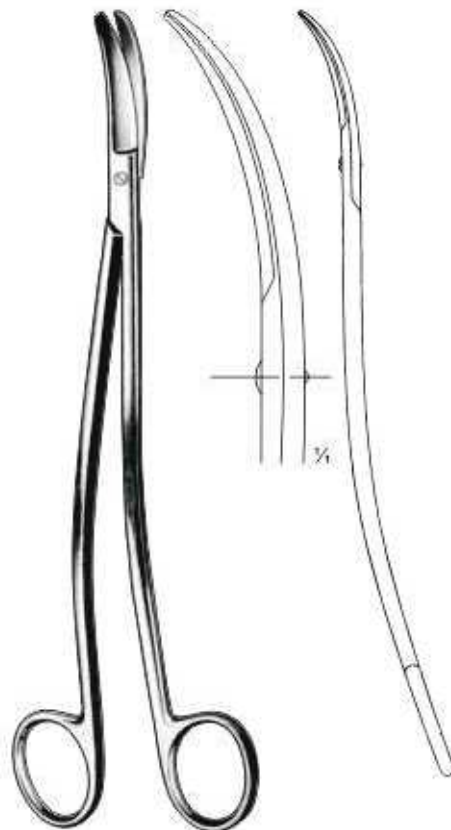

**SATINSKY**  
Z-15-382-245  
24.5 cm, 9 3/4"

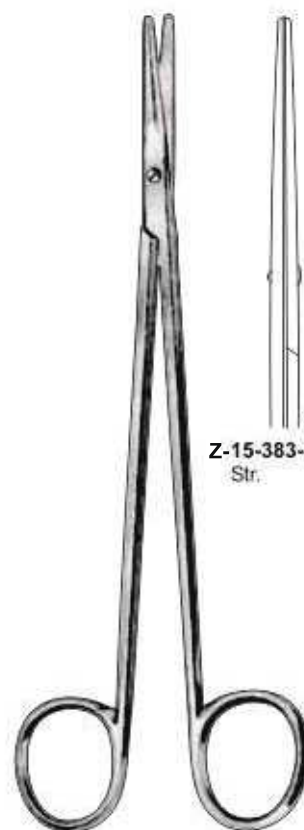

**LINCOLE**  
17.0 cm, 6 3/4"

Z-15-383-170  
Str.

Z-15-384-170  
Cvd.

VASCULAR, ENTEROTOMY SCISSORS



Gefäßscheren, Darmscheren  
Tijeras vasculares, Tijeras para intestino

Ciseaux vasculaires, Ciseaux-entérotomes  
Forbici vascolari, Forbici per enterotomia



**ENTEROTOMY**  
Z-15-385-210  
21.0 cm, 8 1/4"



**ENTEROTOMY**  
Z-15-386-210  
21.0 cm, 8 1/4"



**ENTEROTOMY**  
Z-15-387-210  
21.0 cm, 8 1/4"



**DISSECTING**  
Z-15-388-110 11.5 cm, 4 1/4"  
Z-15-389-130 13.0 cm, 5"  
Z-15-390-140 14.0 cm, 5 1/2"



**DISSECTING**  
Z-15-391-110 11.5 cm, 4 1/4"  
Z-15-392-130 13.0 cm, 5"  
Z-15-393-140 14.0 cm, 5 1/2"

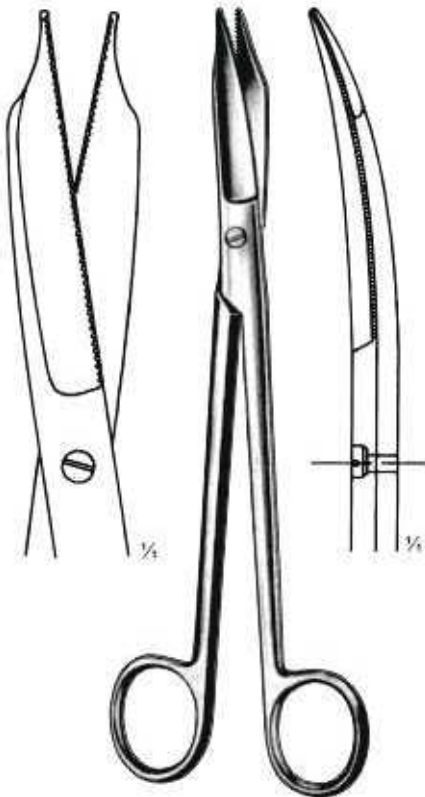

**MARTIN-CARTILAGE**  
Z-15-394-200  
20.0 cm, 8"



**MC INDOE**  
Z-15-395-190  
19.0 cm, 7 1/2"

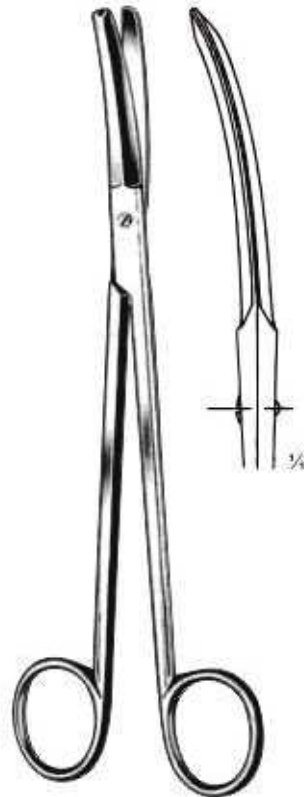

**POTTS-SMITH**  
Z-15-396-190  
19.0 cm, 7 1/2"

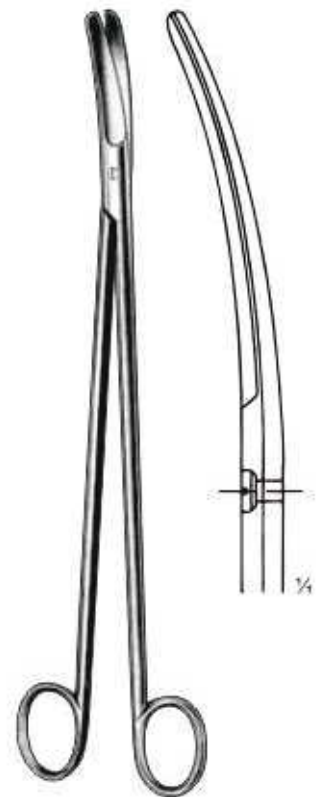

**CRAFOORD**  
Z-15-397-300  
30.0 cm, 11 3/4"

# TONSIL, NASAL SCISSORS

Tonsillenscheren, Nasenscheren  
Tijeras para amígdalas, Tijeras nasales

Ciseaux pour les amygdales, Ciseaux nasaux  
Forbici per tonsille, Forbici nasali

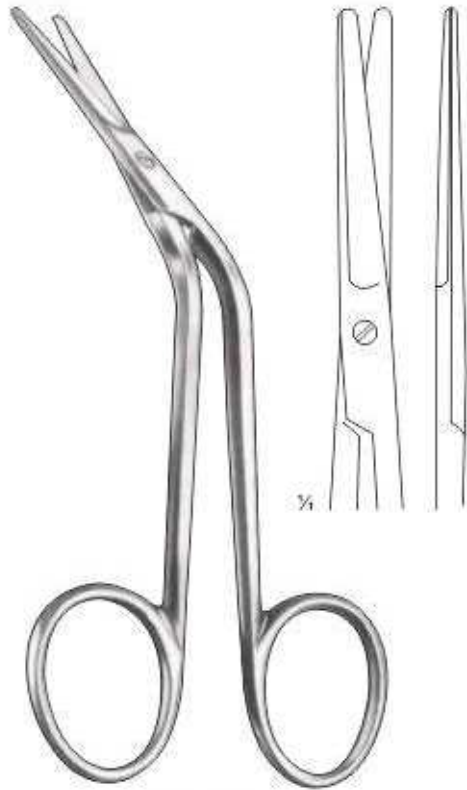

**COTTLE**  
Z-15-398-160  
16 cm 6 1/4"

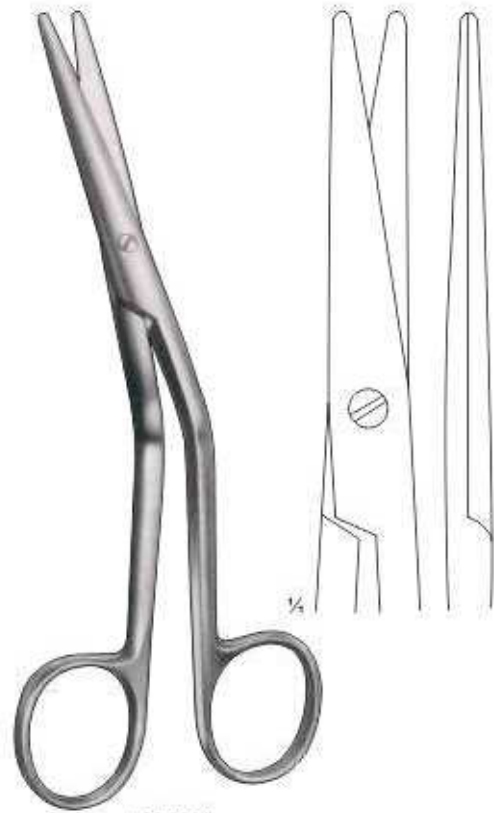

**FOMON**  
Z-15-399-145  
14.5 cm 5 1/2"



**HEYMANN**  
Z-15-400-180  
18 cm, 7"



**HEYMANN**  
Z-15-401-195  
19.5 cm, 7 1/2"



**KNIGHT**  
Z-15-402-180  
18.0 cm, 7"

Zahnfleischscheren, Chirurgische Scheren  
 Tijeras para encias, Tijeras quirúrgicas

Ciseaux à gencives, Ciseaux chirurgicaux  
 Forbici per gengiva, Forbici per chirurgia



**WAGNER  
 GUM SCISSORS**  
 12.0 cm, 4 1/4"

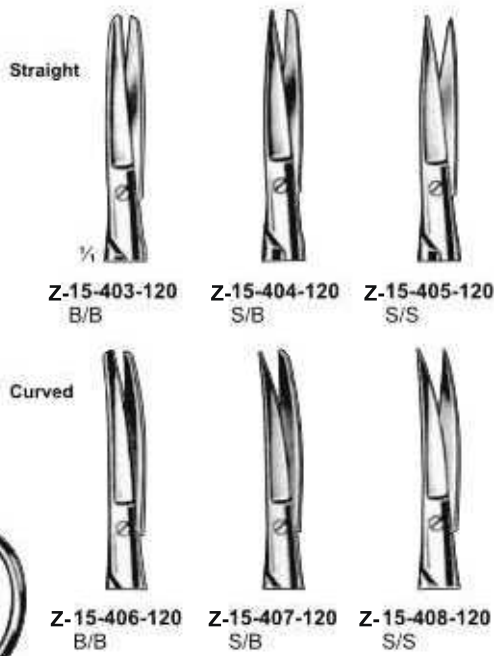

**BROPHY (SULLIVAN)**  
 Z-15-409-140  
 14.0 cm, 5 1/2"  
 Str.

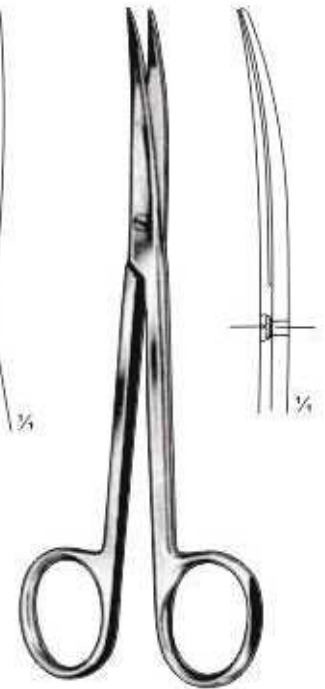

**BROPHY (SULLIVAN)**  
 Z-15-410-140  
 14.0 cm, 5 1/2"  
 Cvd.



**GOOD**  
 Z-15-411-190  
 19.0 cm, 7 1/2"



**PRINCE**  
 Z-15-412-175  
 17.5 cm, 6 3/4"

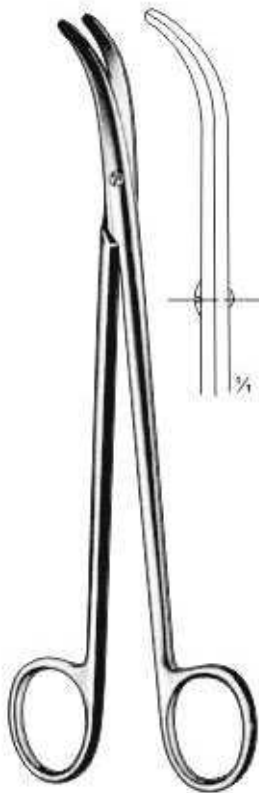

**HALLE**  
 Z-15-413-190  
 19.0 cm, 7 1/2"



**SULLIVAN**  
 Z-15-414-145  
 14.5 cm, 5 3/4"



**SULLIVAN**  
 Z-15-415-145  
 14.5 cm, 5 3/4"





**WALTON**  
Z-15-416-100  
10.0 cm, 4"

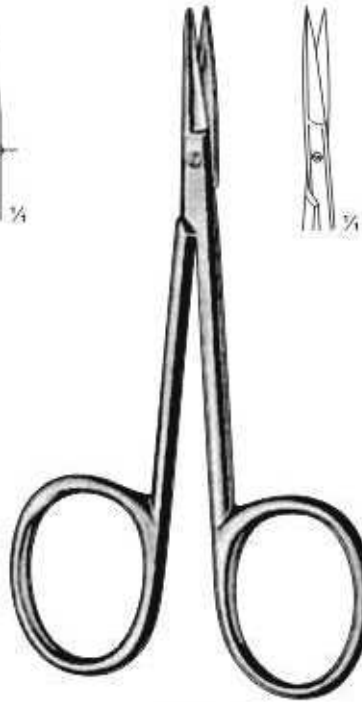

**MOD. BONN**  
Z-15-417-080  
8.0 cm, 3"

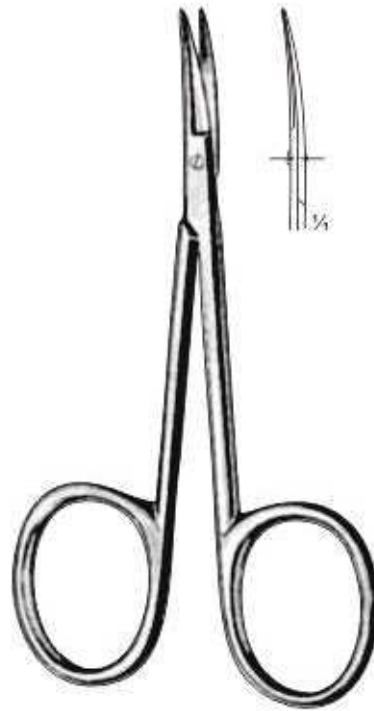

**MOD. BONN**  
Z-15-418-080  
8.0 cm, 3"



**LANDOLT**  
Z-15-419-125  
12.5 cm, 5"



**OPERATING FINE**  
Z-15-420-120 Straight  
Z-15-421-120 Curved  
12 cm, 4 1/2"

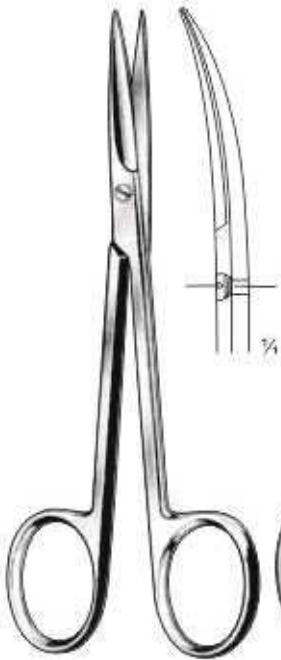

**Z-15-422-140**  
14.0 cm, 5 1/2"

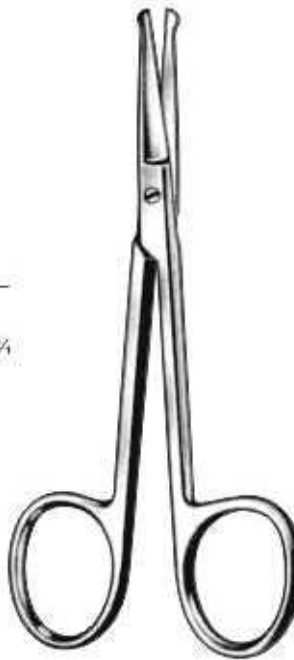

**Z-15-423-105**  
10.5 cm, 4"  
**Z-15-424-115**  
11.5 cm, 4 1/2"



**Z-15-425-105**  
10.5 cm, 4"  
**Z-15-426-115**  
11.5 cm, 4 1/2"



**Z-15-427-115**  
11.5 cm, 4 1/2"

Zahnfleischscheren, Fadenscheren,  
 Tijeras para encías, Tijeras para hilos,

Ciseaux à gencives, Ciseaux à ligatures,  
 Forbici per gengiva, Forbici per legature,

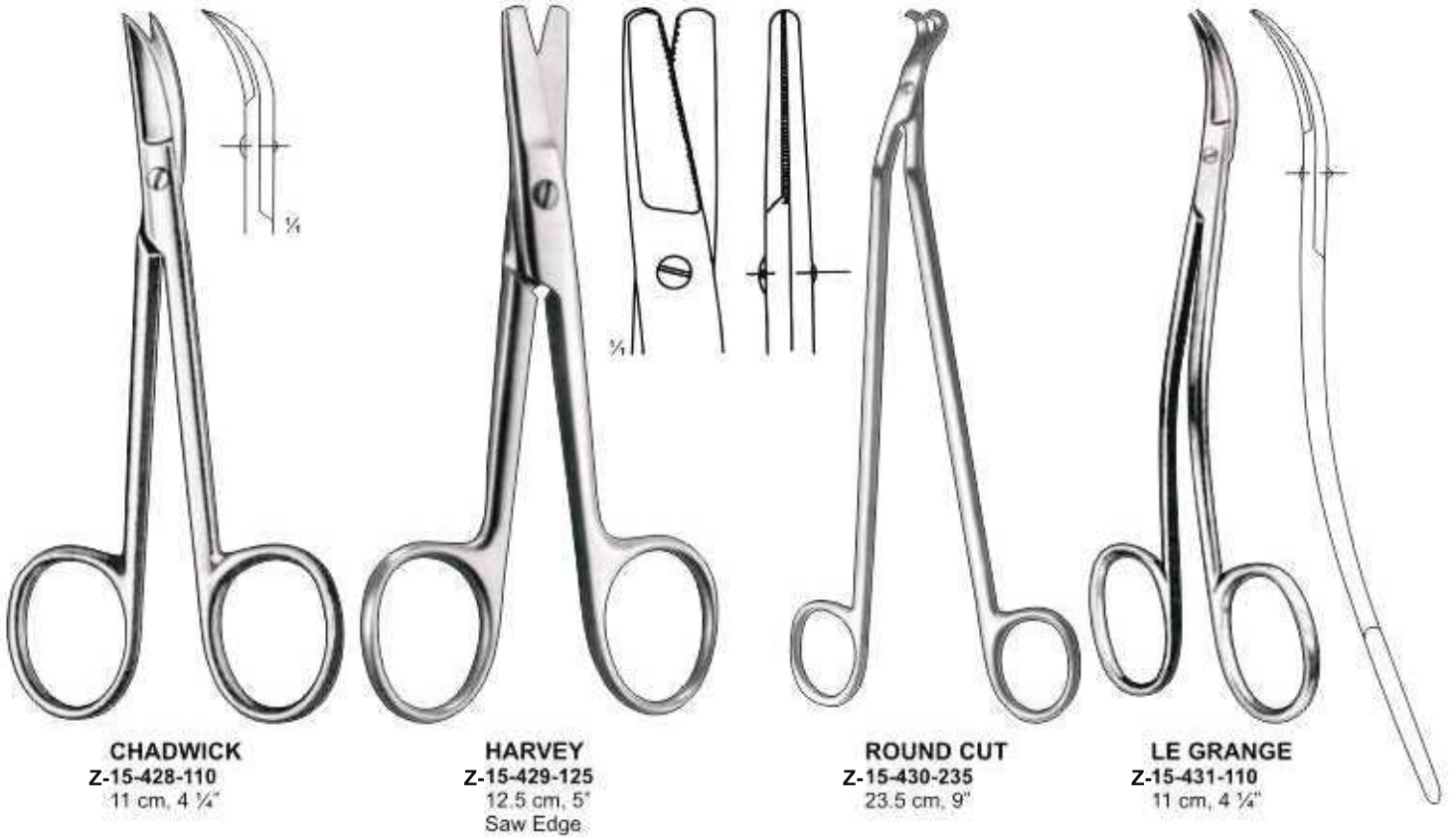

Saw Edge



**Z-15-437-120**  
12.0 cm, 4 3/4"



**NORTHBENT**  
Z-15-438-125  
12.5 cm, 5"



**LITTAUER**  
Z-15-439-140  
14 cm, 5 1/2"



**BUCK**  
Z-15-440-145 14.5 cm, 5 3/4"  
Z-15-441-180 18.0 cm, 7"

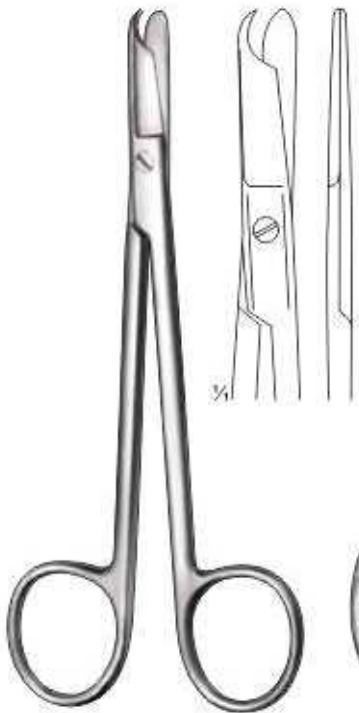

**SPENCER**  
Z-15-442-090  
9 cm, 3 1/2"

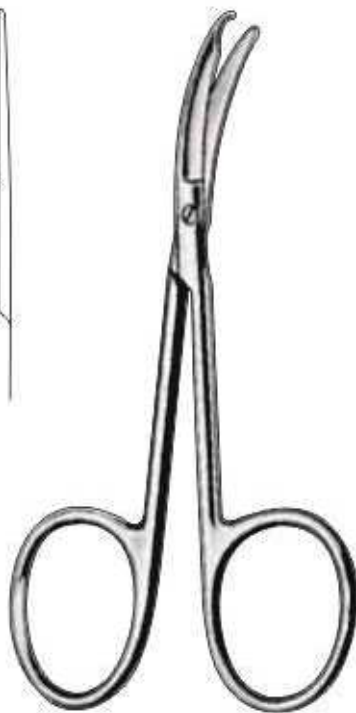

**SHORTBENT**  
Z-15-443-090  
9 cm, 3 1/2"



**SPENCER / DELICATE**  
Z-15-444-110  
11 cm, 4 1/2"



**Z-15-445-115**  
11.5 cm, 4 3/4"

Drahtscheren  
Tijeras para alambres

Cisailles à fils  
Forbici per filo metallico



Z-15-446-090  
9.0 cm, 3 1/2"

Z-15-447-090  
9.0 cm, 3 1/2"

Z-15-448-110  
11.0 cm, 4 1/4"

Z-15-449-110  
11.0 cm, 4 1/4"



Saw Edge

**BEEBEE**  
Z-15-450-120  
12.0 cm, 4 3/4"



Saw Edge

**BEEBEE**  
Z-15-451-120  
12.0 cm, 4 3/4"



**BEEBEE**  
Z-15-452-105  
10.5 cm, 4"



**SMITH**  
Z-15-453-175  
17.5 cm, 6 3/4"



**BEEBEE**  
10.5 cm, 4"  
Straight

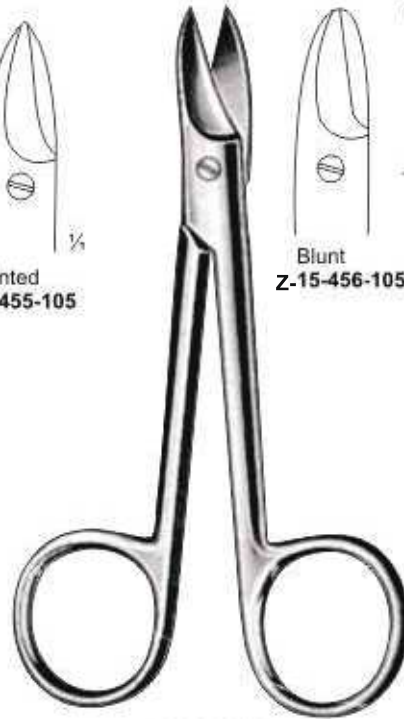
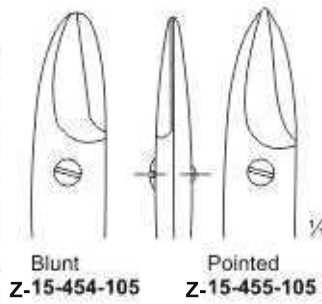

**BEEBEE**  
10.5 cm, 4"  
Curved

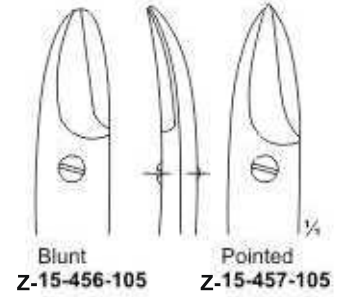

**HARVEY**  
Z-15-458-125  
12.5 cm, 5"

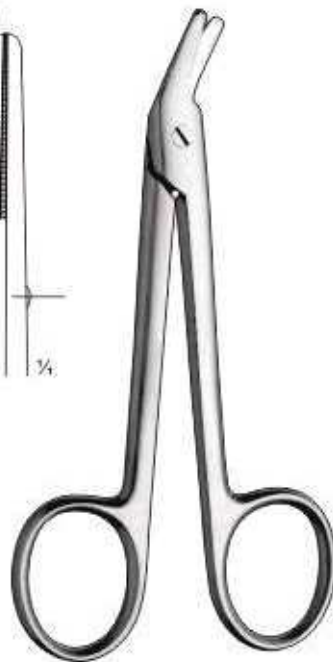
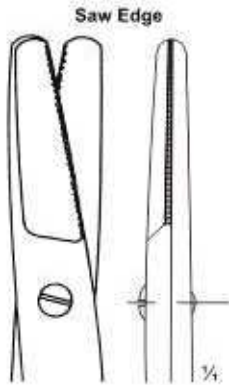

**WIRE CUTTING**  
Z-15-459-115  
11.5 cm, 4 1/2"



**SCHUKNECHT**  
Z-15-460-100  
10.0 cm, 4"

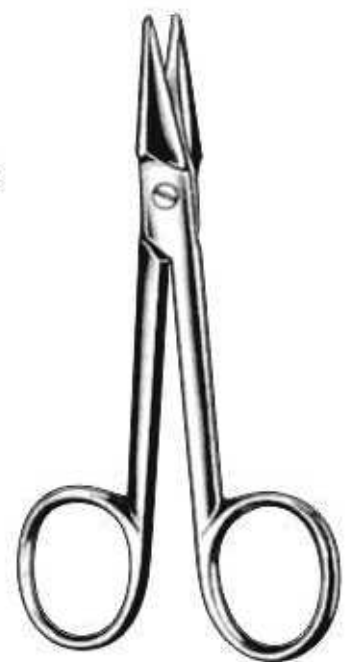

**Z-15-461-110**  
11.0 cm, 4 1/4"



**Z-15-462-090**  
9.0 cm, 3 1/2"  
**Z-15-463-105**  
10.5 cm, 4"

**Z-15-464-090**  
9.0 cm, 3 1/2"  
**Z-15-465-105**  
10.5 cm, 4"

**Z-15-466-090**  
9.0 cm, 3 1/2"  
**Z-15-466-105**  
10.5 cm, 4"

**Z-15-467-130**  
13.0 cm, 5"  
**Z-15-467-155**  
15.5 cm, 6"



**NAIL SCISSORS**  
**Z-15-468-090**  
9 cm, 3 1/2"  
Curved

**NAIL SCISSORS**  
**Z-15-469-090**  
9 cm, 3 1/2"  
Curved

**NAIL SCISSORS**  
**Z-15-470-090**  
9 cm, 3 1/2"  
Arrow Point  
Curved

**Z-15-471-090**  
9.0 cm, 3 1/2"  
**Z-15-472-105**  
10.5 cm, 4"

**Z-15-473-090**  
9.0 cm, 3 1/2"  
**Z-15-474-105**  
10.5 cm, 4"

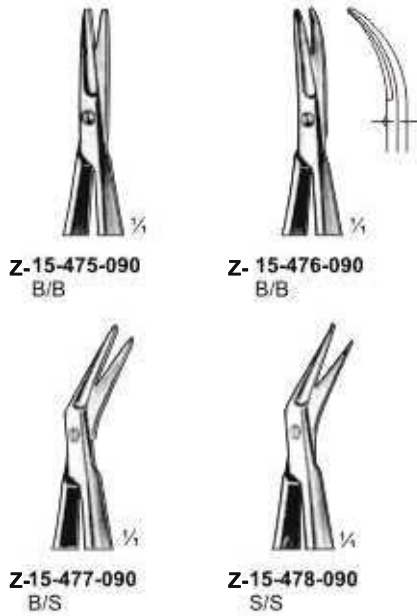

**CASTROVIEJO**  
9.0 cm, 3 1/2"



Z-15-479-100  
Sharp

**CASTROVIEJO**  
10.0 cm, 4"



Z-15-480-100  
Blunt

**CASTROVIEJO**  
10.0 cm, 4"



**NOYES**  
A Z-15-481-120  
B Z-15-482-120  
C Z-15-483-120  
12 cm, 4 3/4"



**NOYES**  
Z-15-484-120  
12 cm, 4 3/4"



**WECKER**  
11.0 cm, 4 1/4"



**BARRAQUER**  
Z-15-488-055  
Z-15-489-055  
Z-15-490-055  
5.5 cm, 2 1/4"



**CASTROVIEJO**  
Z-15-491-110  
11.0 cm, 4 1/4"



**CASTROVIEJO**  
Z-15-492-110  
11.0 cm, 4 1/4"



**TROUTMAN**  
Z-15-493-100  
10.0 cm, 4"



**TROUTMAN**  
Z-15-494-100  
10.0 cm, 4"



**WESTCOTT**  
Z-15-495-110  
11.0 cm, 4 1/4"



**WESTCOTT**  
Z-15-496-110  
11.0 cm, 4 1/4"



**CASTROVIEJO**  
Z-15-497-100  
10.0 cm, 4"



**CASTROVIEJO**  
Z-15-498-100  
10.0 cm, 4"







**Z-15-499-120**  
12.0 cm, 4 1/4"





**WESTCOTT**  
**Z-15-500-115**  
11.5 cm, 4 1/2"



**WESTCOTT**  
**Z-15-501-115**  
11.5 cm, 4 1/2"



**WESTCOTT**

 **Z-15-502-110**  
 11 cm, 4 1/4"  
 Curved  
 Sharp/Sharp  
 **Z-15-504-110**  
 11 cm, 4 1/4"  
 Curved  
 Blunt/Blunt  
**Z-15-503-110**  
 11 cm, 4 1/4"  
 Curved-Micro  
 Sharp/Sharp



**NOYES**  
**Z-15-505-150**  
15.0 cm, 6"



**Z-15-506-145**  
14.5 cm, 5 3/4"



14 cm

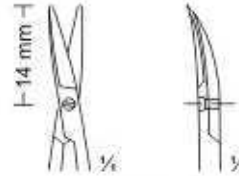

**DISSECTION**  
**Z-15-507-140**

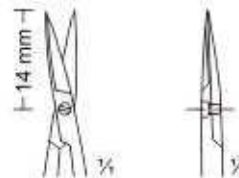

**ADVENTITIA**  
**Z-15-508-140**



**MICRO SCISSOR**  
**Z-15-509-180**  
18 cm, 7"

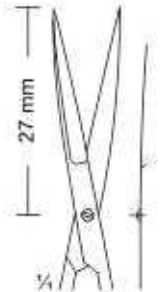

Mikroscheren  
 Micro scissors



**Z-15-510-180**  
 18.0 cm, 7" Str.  
**Z-15-511-180**  
 18.0 cm, 7" Cvd.



**DISSECTION**  
**Z-15-512-180**  
 18 cm, 7" B/B  
**ADVENTITIA**  
**Z-15-513-180**  
 18 cm, 7" S/S

18 cm, 7"



**Z-15-514-145**  
 14.5 cm, 5 3/4" Str.  
**Z-15-515-145**  
 14.5 cm, 5 3/4" Cvd.



**Z-15-516-180**  
 18.0 cm, 7"



15.0 cm, 6"

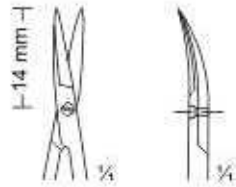

**DISSECTION**  
Z-15-517-150

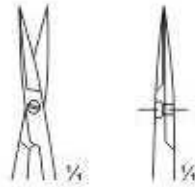

**ADVENTITIA**  
Z-15-518-150

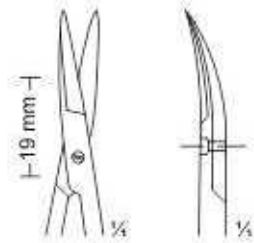

**DISSECTION**  
Z-15-519-150

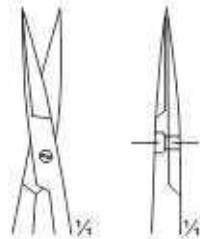

**ADVENTITIA**  
Z-15-520-150

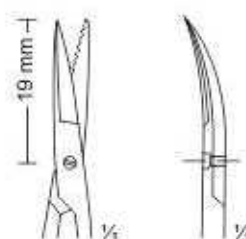

**DISSECTION**  
Z-15-521-150

-Nerve-



**ADVENTITIA**  
Z-15-522-150



11.0 cm, 4 1/4"

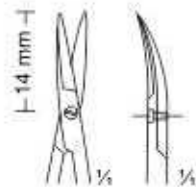

**DISSECTION**  
Z-15-523-110

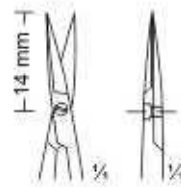

**ADVENTITIA**  
Z-15-524-110



**DISSECTING SCISSORS**  
Z-15-525-110  
11 cm, 4 1/4"



18.5 cm, 7 1/4"

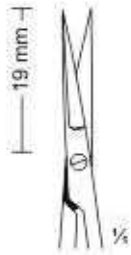

Z-15-526-185  
Str.



Z-15-527-185  
Cvd.



16 cm, 6 1/4" Z-15-528-160  
20 cm, 8" Z-15-529-200  
22 cm, 8 3/4" Z-15-530-220



Z-15-534-160 Z-15-537-160  
Z-15-535-200 Z-15-538-200  
Z-15-536-220 Z-15-539-220



16 cm, 6 1/4" Z-15-540-160  
20 cm, 8" Z-15-541-200  
22 cm, 8 3/4" Z-15-542-220

Z-15-543-160  
Z-15-544-200  
Z-15-545-220



18.0 cm, 7"



Z-15-546-180  
25°



Z-15-547-180  
45°

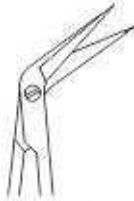

Z-15-548-180  
60°



Z-15-549-180  
90°

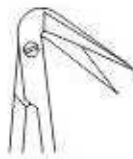

Z-15-550-180  
125°



18.0 cm, 7"



Z-15-551-180  
25°



Z-15-552-180  
45°

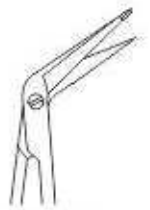

Z-15-553-180  
60°



Z-15-554-180  
90°

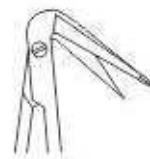

Z-15-555-180  
125°

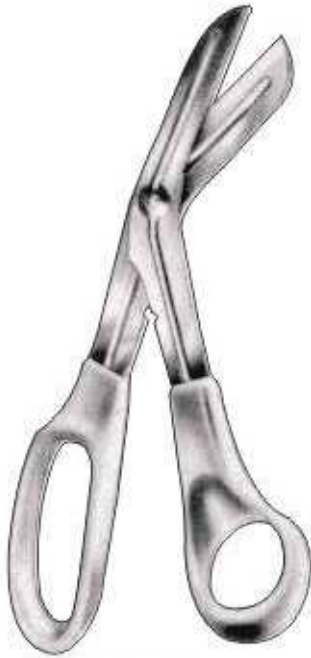

**Z-15-556-200**  
20 cm, 8"



**UNIVERSAL** (Colour Available)  
**Z-15-557-145** 14.5 cm, 5 3/4"  
143 C/290 F Autoclavable  
**Z-15-558-150** 15 cm, 6"  
143 C/290 F Autoclavable  
**Z-15-559-160** 16 cm, 6 1/4"  
143 C/290 F Autoclavable  
**Z-15-560-180** 18 cm, 7"  
143 C/290 F Autoclavable



**UNIVERSAL BANDAGE**  
**Z-15-561-120**  
12 cm, 5"



**ESMARCH**  
**Z-15-562-180**  
18 cm, 7"



**BRUNS**  
**15-564-240**  
24 cm, 9 1/2"  
serrated

**BRUNS**  
**Z-15-563-240**  
24 cm, 9 1/2"  
saw edge



**LISTER**  
**Z-15-565-190**  
Exentric  
19 cm, 7 1/2"



**BERGMANN**  
**Z-15-566-230**  
23 cm, 9"



**ESMARCH**  
**Z-15-567-200**  
20 cm, 8"  
**Z-15-568-220**  
22 cm, 8 3/4"

Gipsschere  
 Tijera para yeso



**BRAUN-STADLER**  
 Z-15-569-140  
 14 cm, 5 1/2"



**BRAUN-STADLER**  
 Z-15-570-200  
 20 cm, 8"



**MODIFIED-USA**  
 Z-15-571-100  
 10 cm, 4"

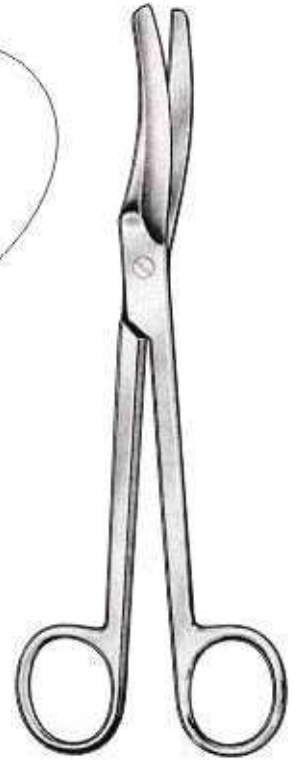
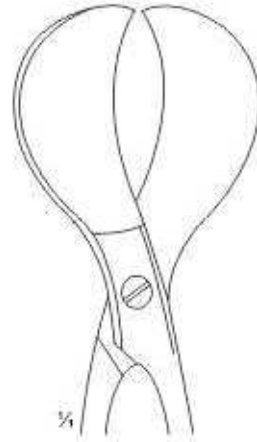

**Z-15-572-200**  
 20 cm, 8"



**WALDMANN**  
 Z-15-573-180  
 18 cm, 7"

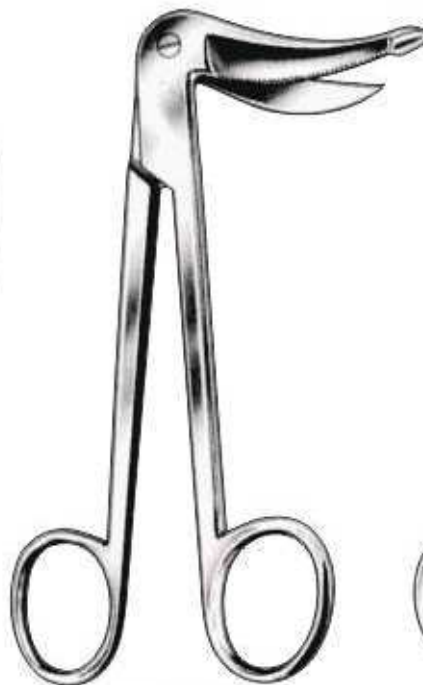

**MARBACH**  
 Z-15-574-155  
 15.5 cm, 6"



**SCHUMACHER**  
 Z-15-575-160  
 16 cm, 6 1/4"



**BUSCH**  
 Z-15-576-130  
 13 cm, 5 1/4"  
 Z-15-577-160  
 16 cm, 6 1/4"



**BERGMANN**  
Z-15-578-180  
18 cm, 7"



Saw Edge  
**Z-15-579-170**  
17 cm, 6 3/4"



**BURNHAM BANDAGE**  
Z-15-580-140  
14 cm, 5 1/2"



**SMITH (MOD. USA)**  
Z-15-581-160 16 cm, 6 1/4"  
Z-15-582-180 18 cm, 7"  
Z-15-583-200 20 cm, 8"  
Z-15-584-230 23 cm, 9"



**LORENZ**  
Z-15-585-230  
23 cm, 9"



**KNOWLES**  
Z-15-586-140  
14 cm, 5 1/2"

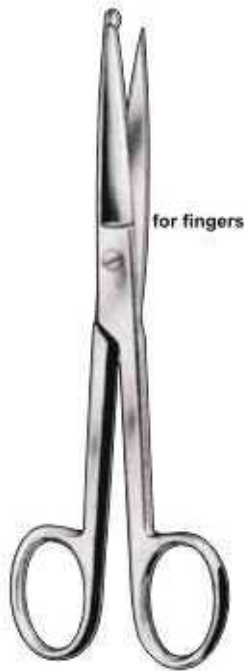

for fingers  
**KNOWLES**  
Z-15-587-210  
14 cm, 5 1/2"



**LISTER**  
Z-15-588-210  
21.0 cm, 8 1/4"



**LISTER BANDAGE**  
Z-15-589-140 14 cm, 5 1/2"  
Z-15-590-160 16 cm, 6 1/4"  
Z-15-591-180 18 cm, 7"  
Z-15-592-200 20 cm, 8"



Saw Edge  
**LISTER-EXCENTRIC**  
Z-15-593-160 16 cm, 6 1/4"  
Z-15-594-190 19 cm, 7 1/2"

Gipsschere  
Tijera para yeso

Ciseaux pour plâtre  
Forbici per gesso



**STILLE**  
Z-15-595-260  
26 cm, 10 1/4"  
Z-15-596-360  
Spare Blade



**STILLE**  
Z-15-597-230  
23 cm, 9"  
Z-15-598-230  
Spare blade



**STILLE**  
Z-15-599-370  
37 cm, 14 1/2"  
Z-15-600-370  
Spare blade



**STILLE**  
Z-15-601-240  
24 cm, 9 1/2"  
Z-15-602-240  
Spare blade





**HENING**  
Z-15-603-270  
27 cm, 10 3/4"



Z-15-604-230  
23 cm, 9"  
3 Prong

**MODEL USA**

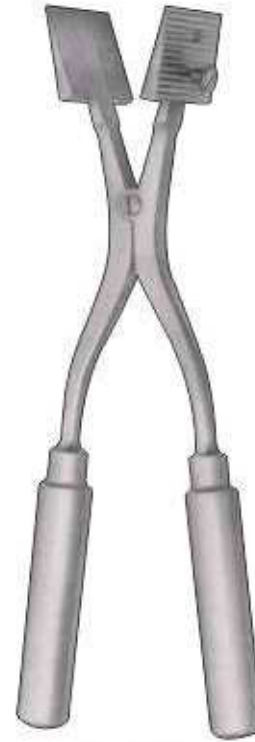

Z-15-605-290  
29 cm, 11 1/2"

With removable jaws



**WOLFF**  
Z-15-606-180 18 cm, 7"  
Z-15-607-240 24 cm, 9 1/2"



**ENGEL  
PLASTER SAW**  
Z-15-608-155  
15.5 cm, 6"



**CHARRIERE**  
Z-15-609-250 25 cm, 10"  
Z-15-610-270 27 cm, 10 3/4"  
Double saw

scheren  
Tijeras



**SAFETY**  
Z-15-611-090 Straight  
Z-15-612-090 Curved  
9.0 cm, 3 1/2"



**GOLDMAN-FOX**  
Z-15-613-090 Straight  
Z-15-614-090 Curved  
9.0 cm, 3 1/2"



**STEVENS TENOTOMY**  
Z-15-615-090 Straight  
Z-15-616-090 Curved  
9.0 cm, 3 1/2"



**STEVENS TENOTOMY**  
Z-15-617-114 Straight  
Z-15-618-114 Curved  
11.4 cm, 4 1/2"



**BABY METZENBAUM**  
Z-15-619-114  
11.4 cm, 4 1/2"  
straight



**BABY METZENBAUM**  
Z-15-620-114  
11.4 cm, 4 1/2"  
Curved



**IRIS**  
Z-15-621-090  
9.0 cm, 3 1/2"  
Z-15-622-114  
11.4 cm, 4 1/2"  
Straight



**IRIS**  
Z-15-623-090  
Z-15-624-090  
9.0 cm, 3 1/2"  
Curved



**IRIS**  
Z-15-625-114  
11.4 cm, 4 1/2"



**METZENBAUM**  
Z-15-626-140 14 cm, 5 1/2"  
Z-15-627-180 18 cm, 7"  
Straight



**METZENBAUM**  
Z-15-628-140 14 cm, 5 1/2"  
Z-15-629-180 18 cm, 7"  
Curved



**METZENBAUM**  
Z-15-630-230 Straight  
Z-15-631-230 Curved  
23 cm, 9"



**METZENBAUM**  
Z-15-632-140  
14 cm, 5 1/2"



**STANDARD**  
Z-15-633-140  
14 cm, 5 1/2"  
Straight



**STANDARD**  
Z-15-634-140  
14 cm, 5 1/2"  
Curved



**METZENBAUM**  
Z-15-635-140 14 cm, 5 1/2"  
Z-15-636-160 16 cm, 6 1/4"  
Z-15-637-180 18 cm, 7"  
Z-15-638-220 20 cm, 8"  
Z-15-639-230 23 cm, 9"  
Z-15-640-280 28 cm, 11"  
Z-15-641-300 30 cm, 11 3/4"

scheren  
Tijeras



**MAYO**  
 Z-15-642-230 23 cm, 9"  
 Straight



**MAYO**  
 Z-15-643-230 23 cm, 9"  
 Curved



**JAMISON**  
 Z-15-644-140 14.0 cm, 5 1/2"  
 Z-15-645-178 17.8 cm, 7"  
 Curved



**POTTS-SMITH**  
 Z-15-646-178 Angled 25°  
 Z-15-647-178 Angled 45°  
 Z-15-648-178 Angled 60°  
 17.8 cm, 7"



**MAYO**  
 Z-15-649-140 14 cm, 5 1/2"  
 Z-15-650-150 15 cm, 6"  
 Z-15-651-180 18 cm, 7"  
 Z-15-652-200 20 cm, 8"  
 Z-15-653-230 23 cm, 9"



**MAYO**  
 Z-15-654-140 14 cm, 5 1/2"  
 Z-15-655-170 17 cm, 6 3/4"  
 Straight



**MAYO**  
 Z-15-656-140 14 cm, 5 1/2"  
 Z-15-657-170 17 cm, 6 3/4"  
 Curved



**STANDARD**

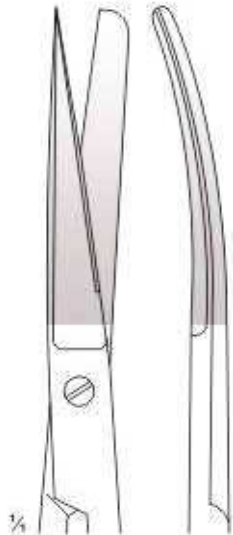

**Z-15-658-145**  
14.5 cm, 5 3/4" Straight  
**Z-15-659-145**  
14.5 cm, 5 3/4" Curved

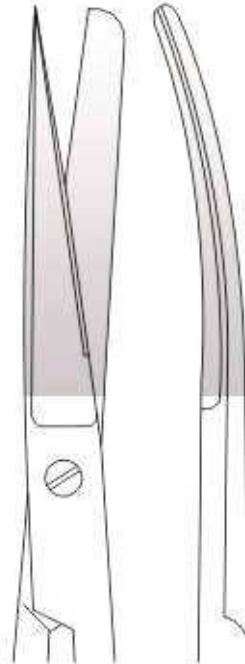

**Z-15-660-165**  
16.5 cm, 6 1/2" Straight  
**Z-15-661-165**  
16.5 cm, 6 1/2" Curved

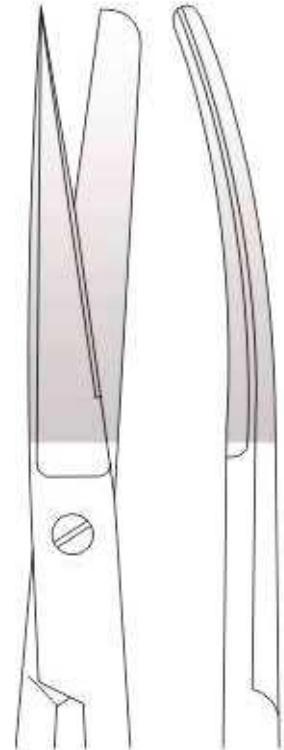

**Z-15-662-185**  
18.5 cm, 7 1/4" Straight  
**Z-15-663-185**  
18.5 cm, 7 1/4" Curved



**STANDARD**

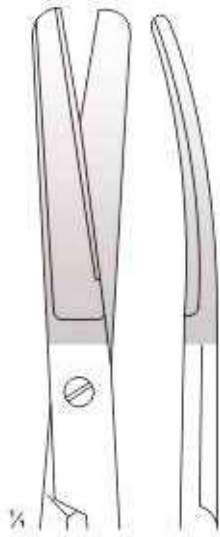

**Z-15-664-145**  
14.5 cm, 5 3/4" Straight  
**Z-15-665-145**  
14.5 cm, 5 3/4" Curved

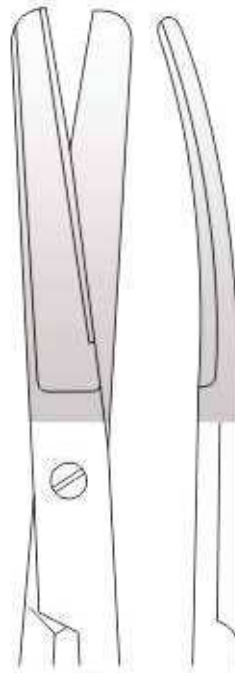

**Z-15-666-165**  
16.5 cm, 6 1/2" Straight  
**Z-15-667-165**  
16.5 cm, 6 1/2" Curved

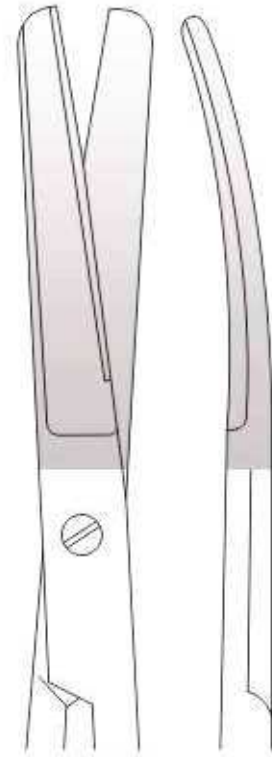

**Z-15-668-185**  
18.5 cm, 7 1/4" Straight  
**Z-15-669-185**  
18.5 cm, 7 1/4" Curved

OPERATING SCISSORS T.C. INSERTED



Chirurgische scheren  
Tijeras quirúrgicas

Ciseaux chirurgicaux  
Forbici per chirurgia

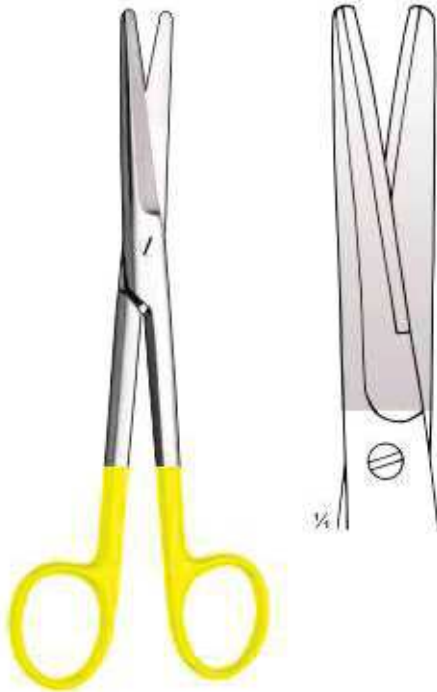

**MAYO**  
Z-15-670-140 14 cm, 5 1/2"  
Z-15-671-170 17 cm, 6 3/4"  
Z-15-672-230 23 cm, 9"  
blunt/blunt

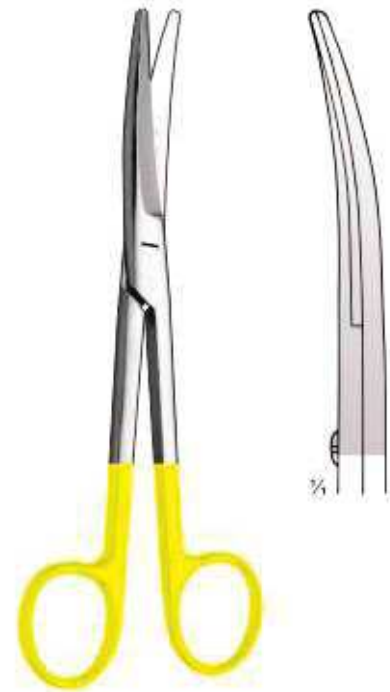

**MAYO**  
Z-15-673-140 14 cm, 5 1/2"  
Z-15-674-170 17 cm, 6 3/4"  
Z-15-675-230 23 cm, 9"  
blunt/blunt, Cvd.



**STANDARD**

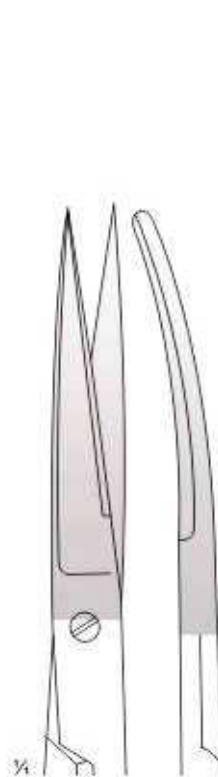

Z-15-676-145  
14.5 cm, 5 3/4" Straight  
Z-15-677-145  
14.5 cm, 5 3/4" Curved

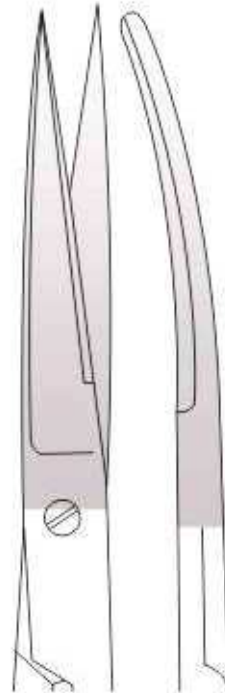

Z-15-678-165  
16.5 cm, 6 1/2" Straight  
Z-15-679-165  
16.5 cm, 6 1/2" Curved

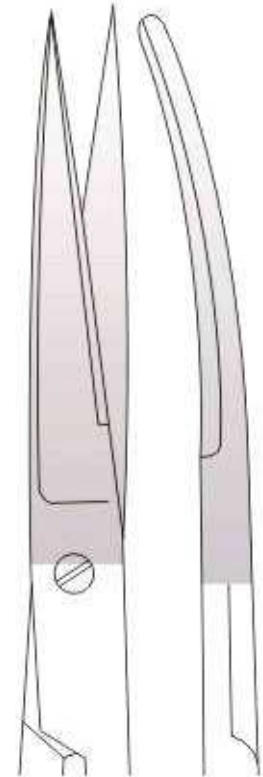

Z-15-680-185  
18.5 cm, 7 1/4" Straight  
Z-15-681-185  
18.5 cm, 7 1/4" Curved



**MAYO-STILLE**  
Z-15-682-150 15 cm, 6"  
Z-15-683-170 17 cm, 6 3/4"  
blunt/blunt, Cvd.



**LEXER**  
Z-15-684-160 16 cm, 6 1/4"  
Z-15-685-215 21.5 cm, 8 1/2"  
blunt/blunt, Str.



**LEXER**  
Z-15-686-160 16 cm, 6 1/4"  
Z-15-687-215 21.5 cm, 8 1/2"  
blunt/blunt, Cvd.



**PARAMETRIUM**  
23 cm, 9"

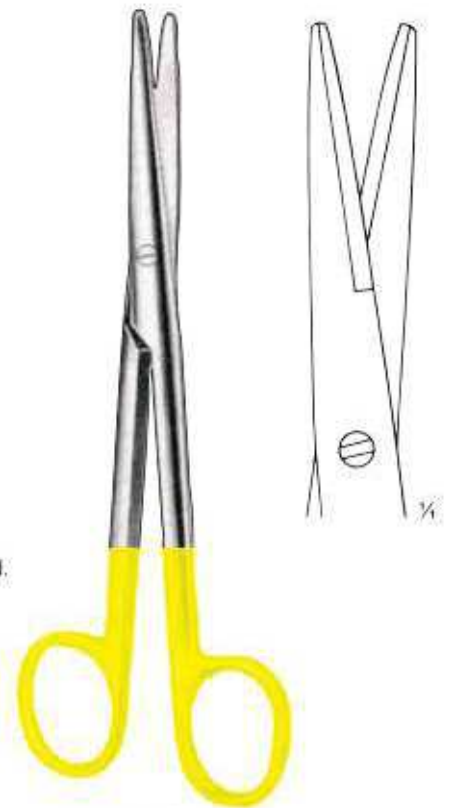
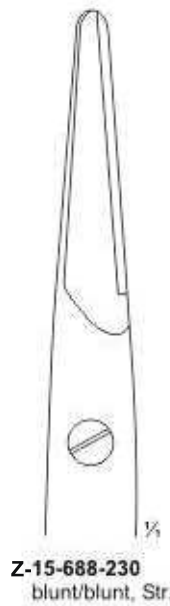

**MAYO-STILLE**  
Z-15-691-150 15 cm, 6"  
Z-15-692-170 17 cm, 6 3/4"  
blunt/blunt, Str.

OPERATING SCISSORS T.C. INSERTED

Chirurgische scheren  
Tijeras quirúrgicas

Ciseaux chirurgicaux  
Forbici per chirurgia



**GOLDMAN-FOX**  
Z-15-693-130  
13.0 cm, 5"

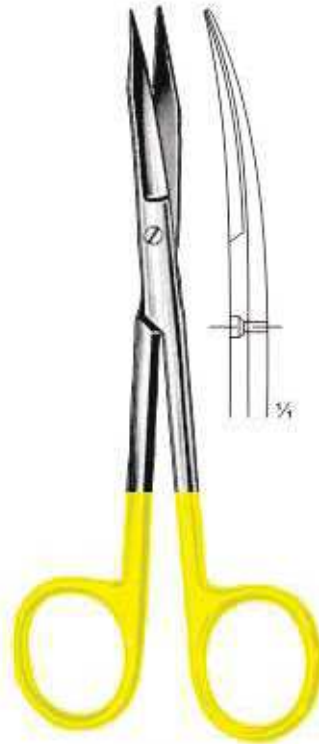

**GOLDMAN-FOX**  
Z-15-694-130  
13.0 cm, 5"

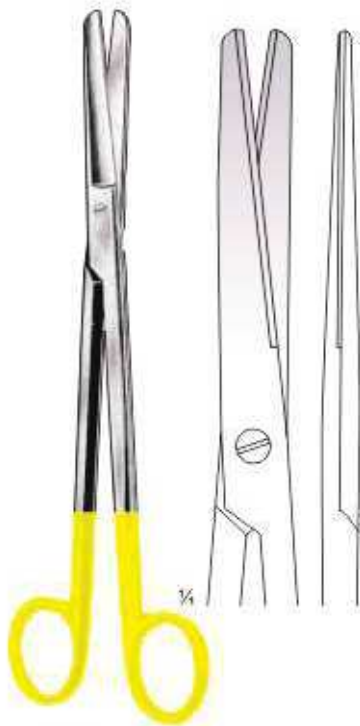

**SIMS**  
Z-15-695-230  
23.0 cm, 9"  
Straight



**SIMS**  
Z-15-696-230  
23.0 cm, 9"  
Curved



**CARDINALE**  
Z-15-697-280  
28.0 cm, 11"



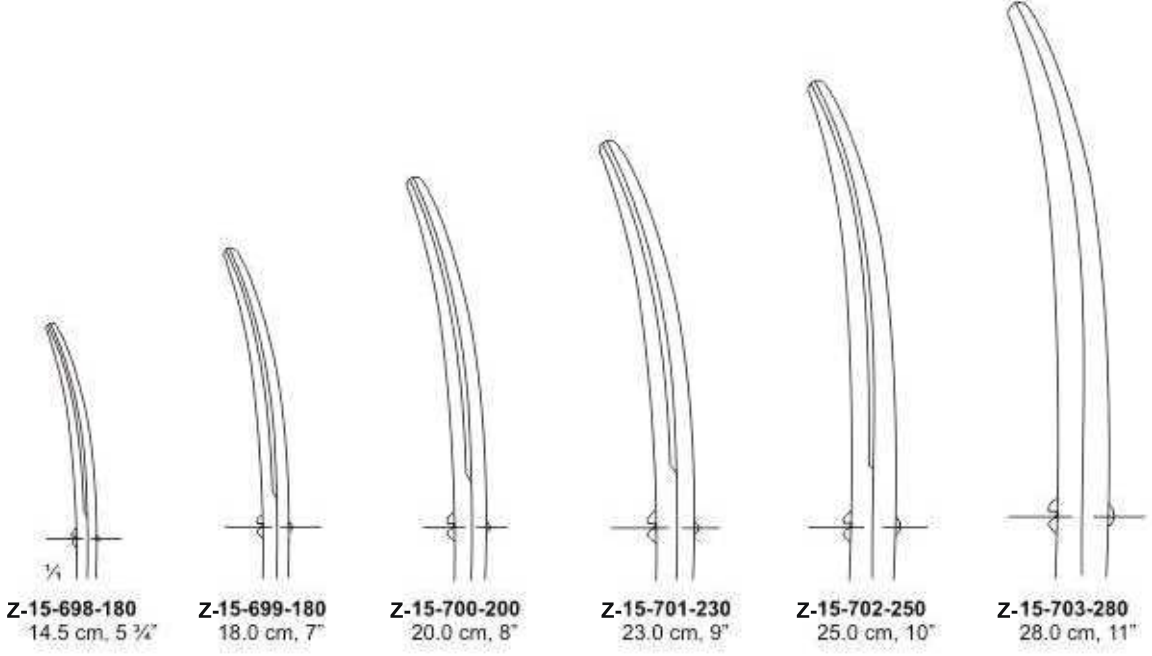

**Z-15-698-180**  
14.5 cm, 5 3/4"

**Z-15-699-180**  
18.0 cm, 7"

**Z-15-700-200**  
20.0 cm, 8"

**Z-15-701-230**  
23.0 cm, 9"

**Z-15-702-250**  
25.0 cm, 10"

**Z-15-703-280**  
28.0 cm, 11"

**METZENBAUM  
DELICATE**  
Blunt / Blunt  
Curved

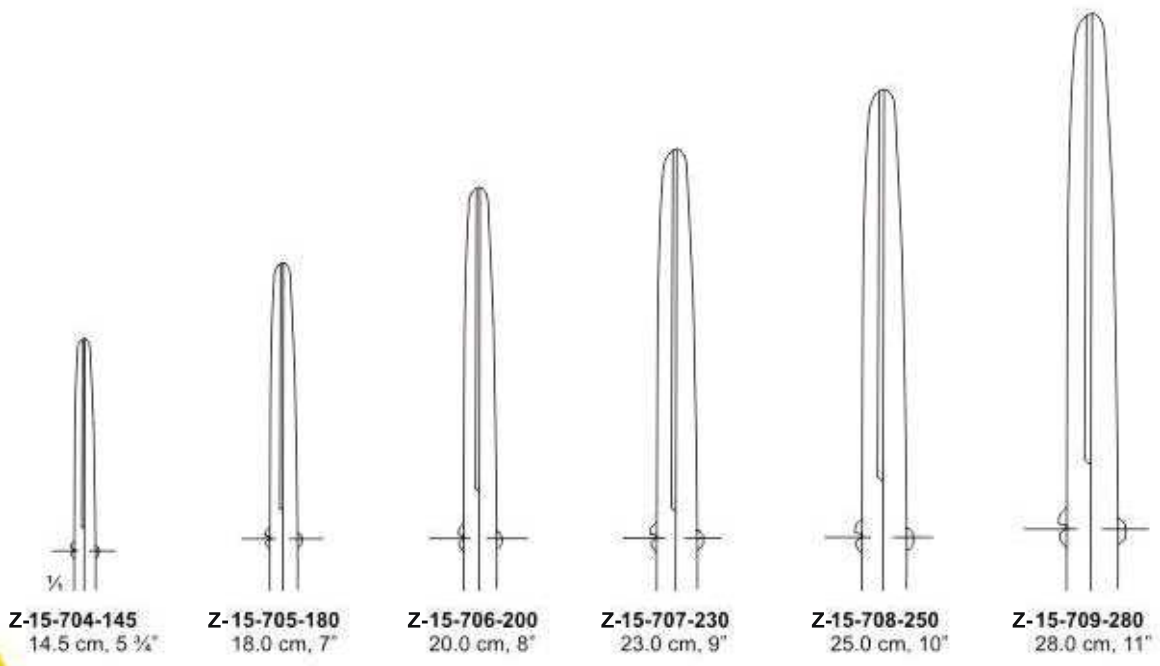

**Z-15-704-145**  
14.5 cm, 5 3/4"

**Z-15-705-180**  
18.0 cm, 7"

**Z-15-706-200**  
20.0 cm, 8"

**Z-15-707-230**  
23.0 cm, 9"

**Z-15-708-250**  
25.0 cm, 10"

**Z-15-709-280**  
28.0 cm, 11"

**METZENBAUM  
DELICATE**  
Blunt / Blunt  
Straight

DISSECTING SCISSORS T.C. INSERTED



Präparierscheren  
Tijeras de disección

Ciseaux à dissection  
Forbici per dissezione

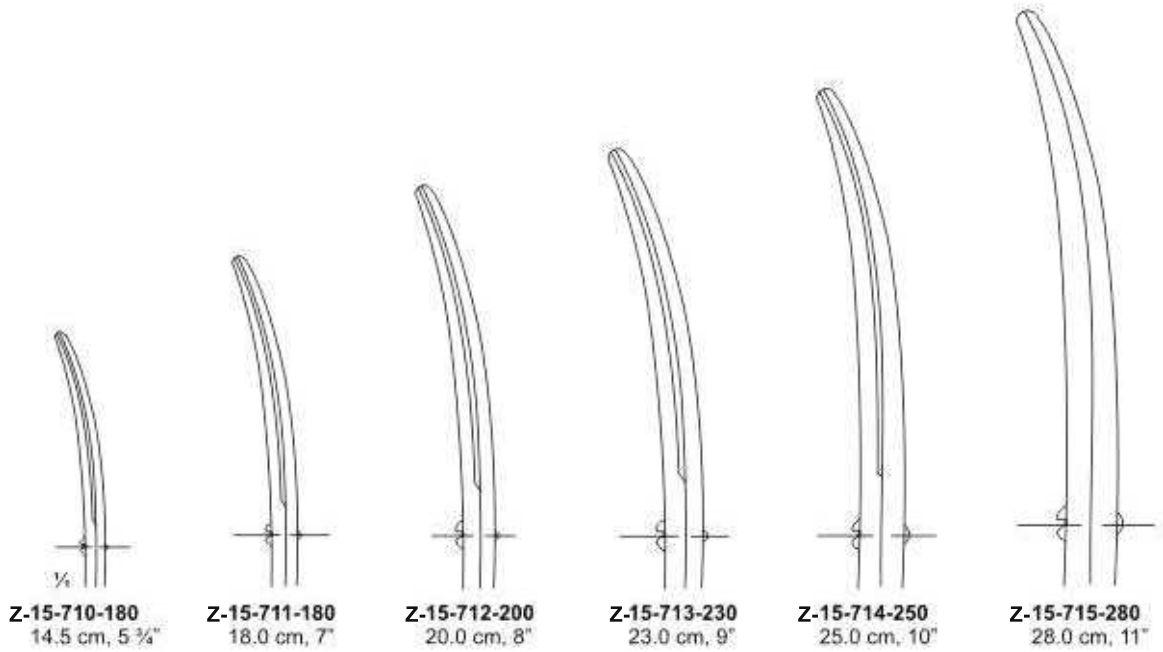

**METZENBAUM  
DELICATE**  
Sharp / Sharp  
Curved

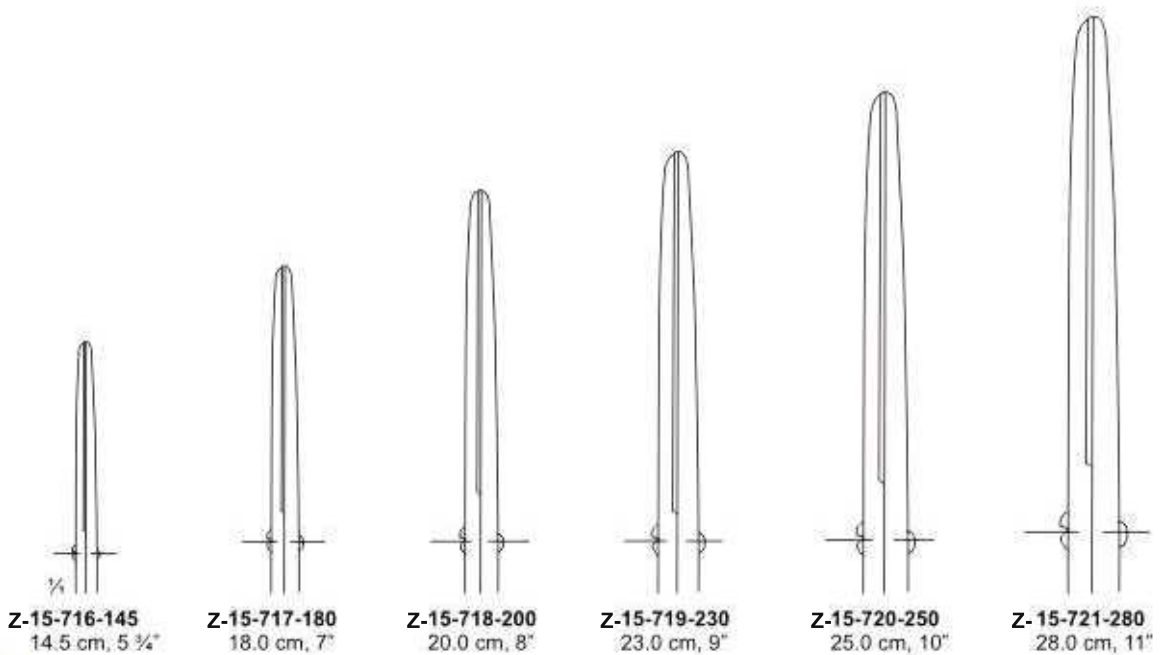

**METZENBAUM  
DELICATE**  
Sharp / Sharp  
Straight

Chirurgische scheren, Präparierscheren  
Tijeras quirúrgicas, Tijeras de disección

Ciseaux chirurgicaux, Ciseaux à dissection  
Forbici per chirurgia, Forbici per dissezione

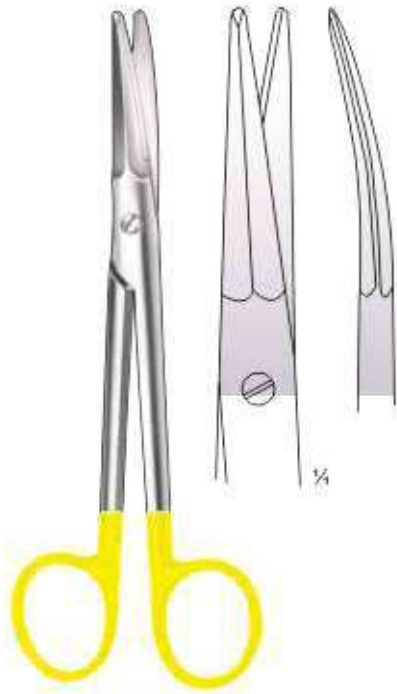

**REES**  
Z-15-722-180  
18 cm, 7"

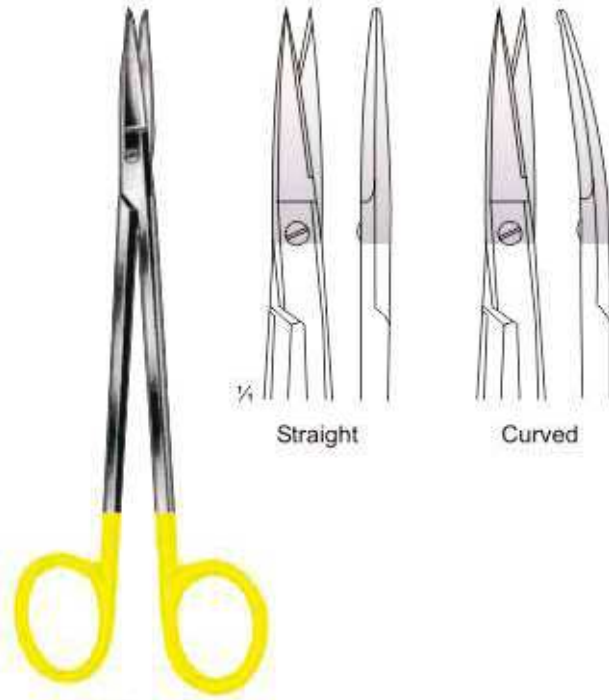

**KELLY**  
Z-15-723-160  
Z-15-724-160  
16 cm, 6 1/4"

Z-  
Z-

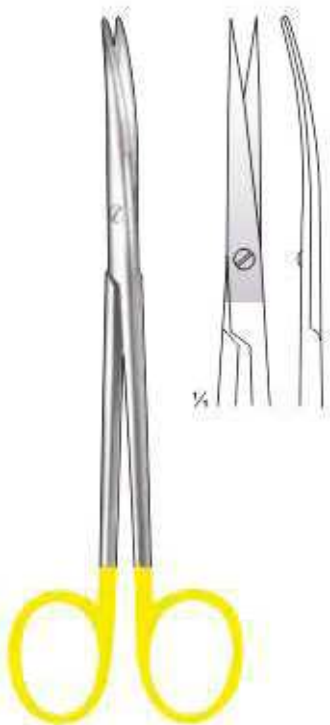

**METZENBAUM-LAHEY**  
Z-15-725-140 14.0 cm, 5 1/2" Sharp/Sharp  
Z-15-726-205 20.5 cm, 8" Blunt/Blunt  
Z-15-727-230 23.0 cm, 9" Blunt/Blunt

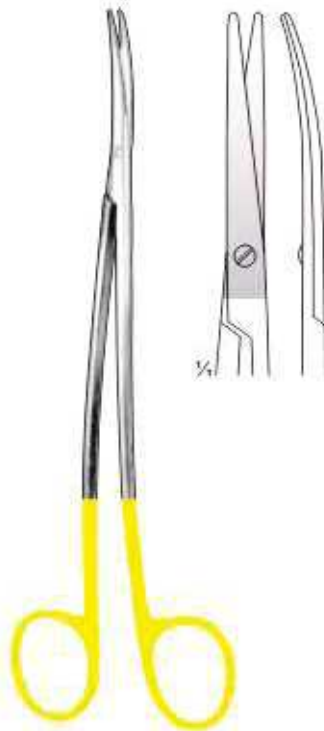

**METZENBAUM-LAHEY**  
Z-15-728-180 18.0 cm, 7" Str.  
Z-15-729-205 20.5 cm, 8" Cvd.  
Z-15-730-230 23.0 cm, 9" Cvd.

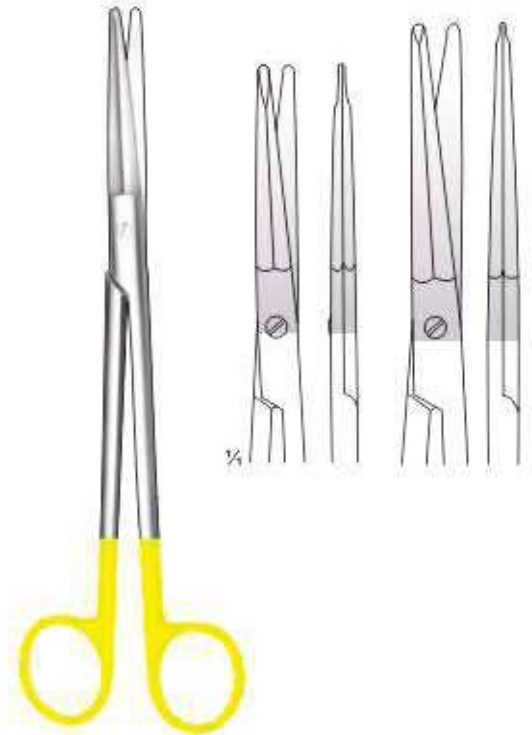

**GORNEY**  
Z-15-731-200 20 cm, 8"  
Z-15-732-230 23 cm, 9"

# VASCULAR, DISSECTING & PLASTER SCISSORS T.C. INSERTED



Gefäßscheren, Präparierscheren, Gipsschere

Ciseaux vasculaires, Ciseaux à dissection, Ciseaux pour plâtre

Tijeras vasculares, Tijeras de disección, Tijera para yeso

Forbici vascolari, Forbici per dissezione, Forbici per gesso

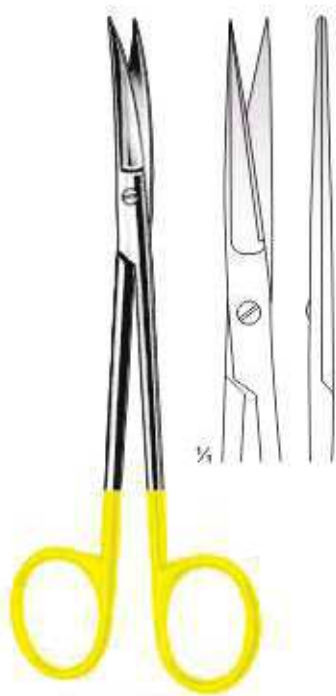

**JOSEPH**  
Z-15-733-145  
14.5 cm, 5 3/4"

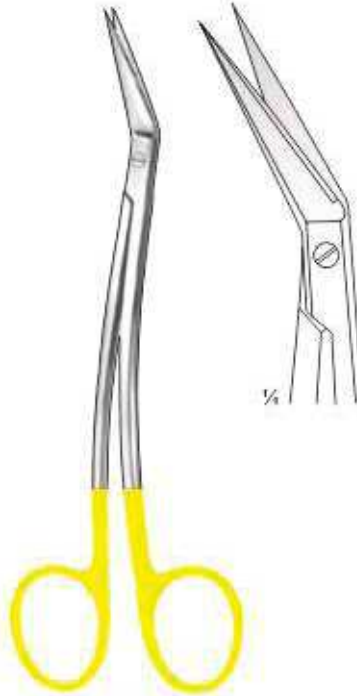

**GUM SCISSORS**  
Locklin  
Z-15-734-160  
16 cm, 6 1/4"

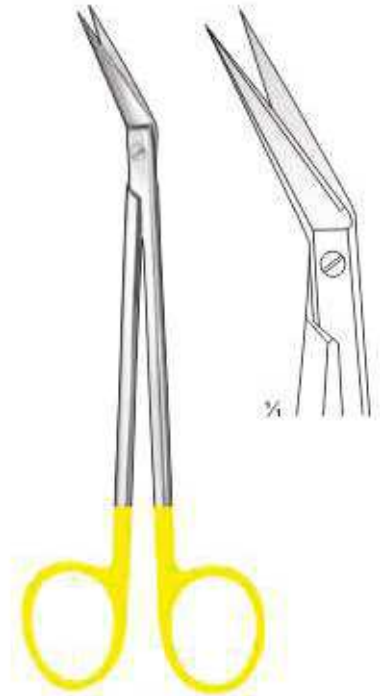

**GUM SCISSORS**  
Locklin  
Z-15-735-160  
16 cm, 6 1/4"



**RAGNELL**  
Z-15-736-125  
12.5 cm, 5"

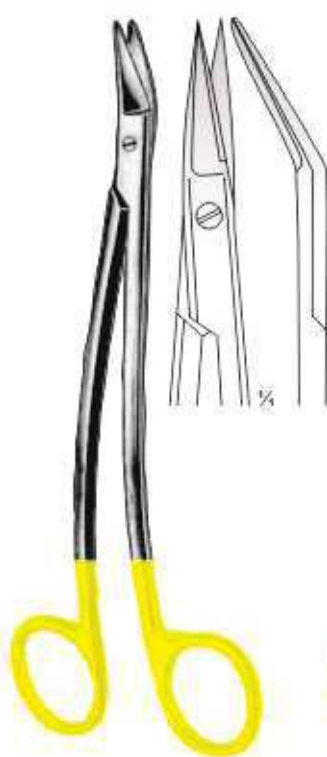

**DEAN**  
Z-15-737-175  
17.5 cm, 6 3/4"

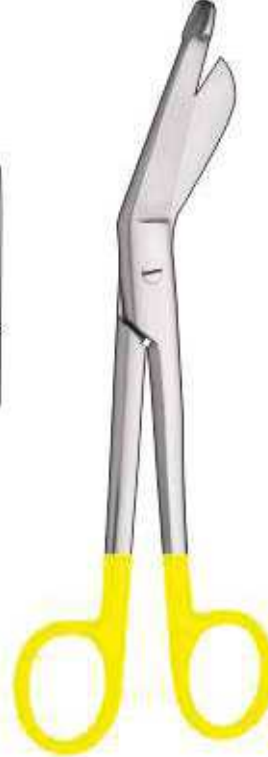

**LISTER BANDAGE**  
Z-15-738-140 14 cm, 5 1/2"  
Z-15-739-160 16 cm, 6 1/4"  
Z-15-740-180 18 cm, 7"  
Z-15-741-200 20 cm, 8"

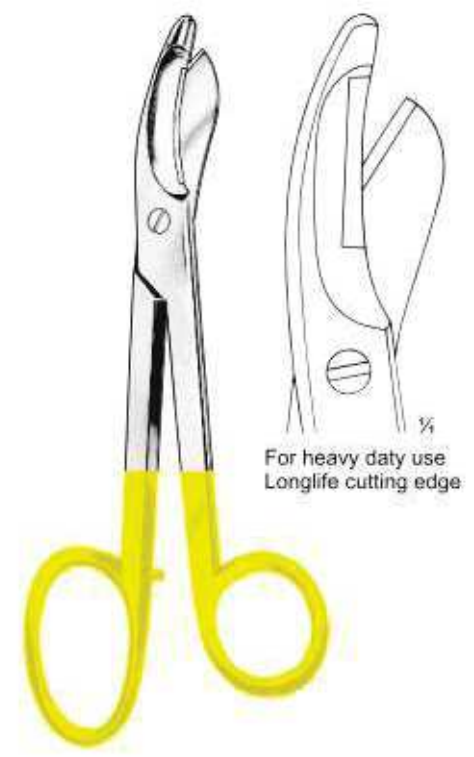

**BRUNS SCISSORS**  
Z-15-742-210  
21 cm, 8 1/4"



**DEBAKEY**

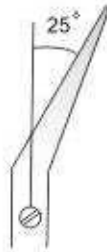

**Z-15-743-165**  
16.5 cm 6 1/2"

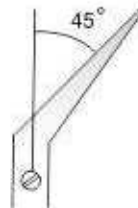

**Z-15-744-180**  
18.0 cm 7"

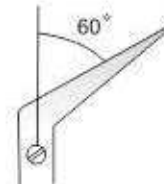

**Z-15-745-185**  
18.5cm 7 1/4"



**Z-15-746-190**  
19.0 cm 7 1/2"

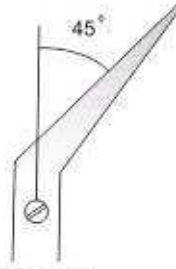

**Z-15-747-220**  
22.0 cm 8 3/4"

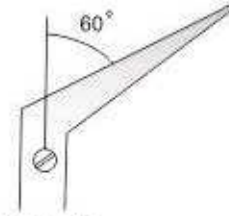

**Z-15-748-230**  
23.0 cm 9"

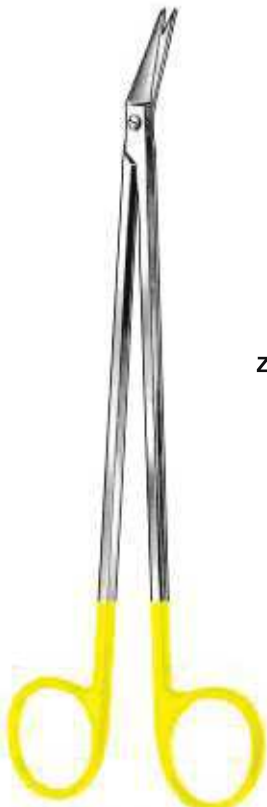

**POTTS-SMITH**  
19.0 cm, 7 1/2"



**Z-15-749-190**



**Z-15-750-190**



**Z-15-751-190**



**IRIS**  
Z-15-752-110  
11cm 4 1/2"

Irisscheren  
 Tijeras para Iridectomia

Ciseaux à iridectomie  
 Forbici per iridectomia

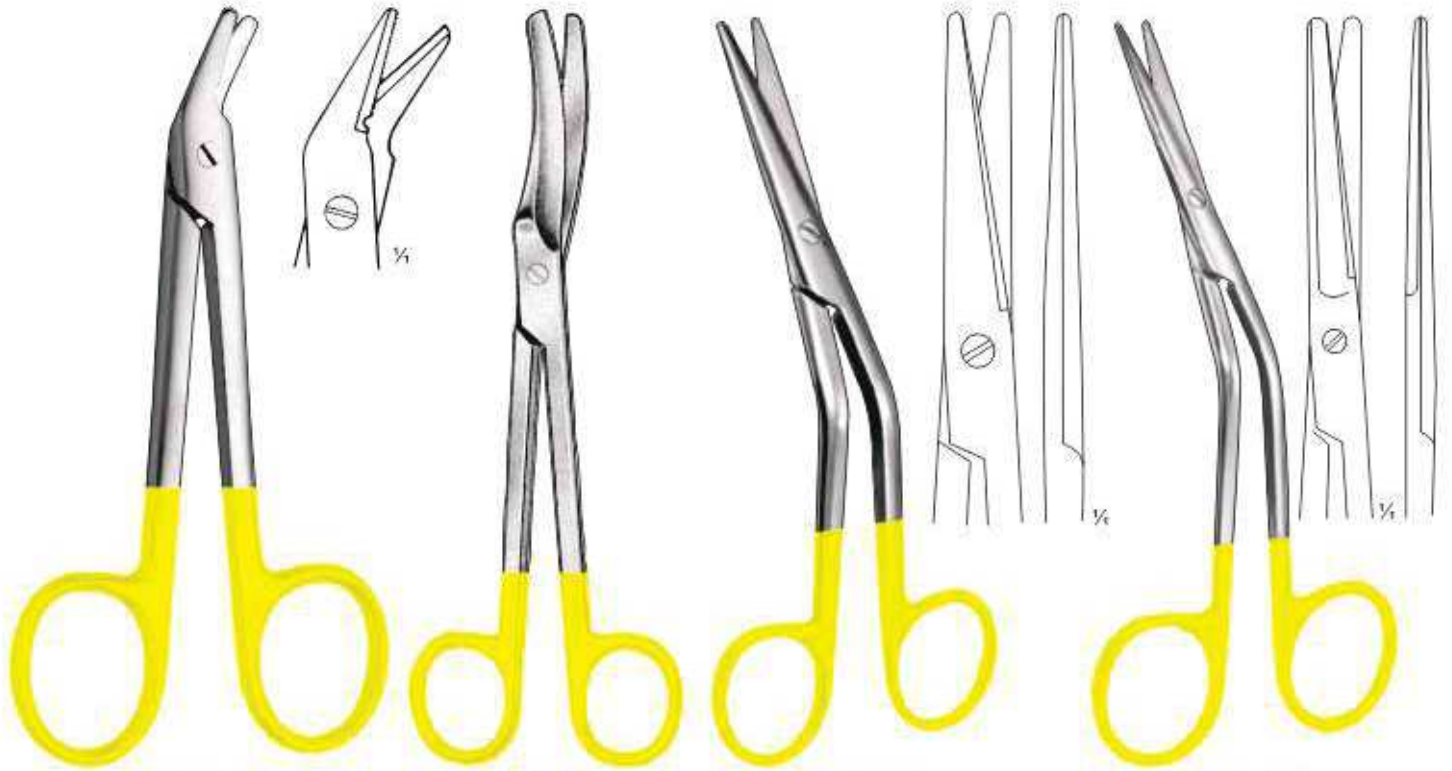

**WIRE CUTTING**  
**Z-15-753-115**  
 11.5 cm, 4 1/2"

**Z-15-754-200**  
 20.0 cm, 8"

**FOMON**  
**Z-15-755-145**  
 14.5cm, 5 3/4"

**COTTLE**  
**Z-15-756-160**  
 16 cm, 6 1/4"

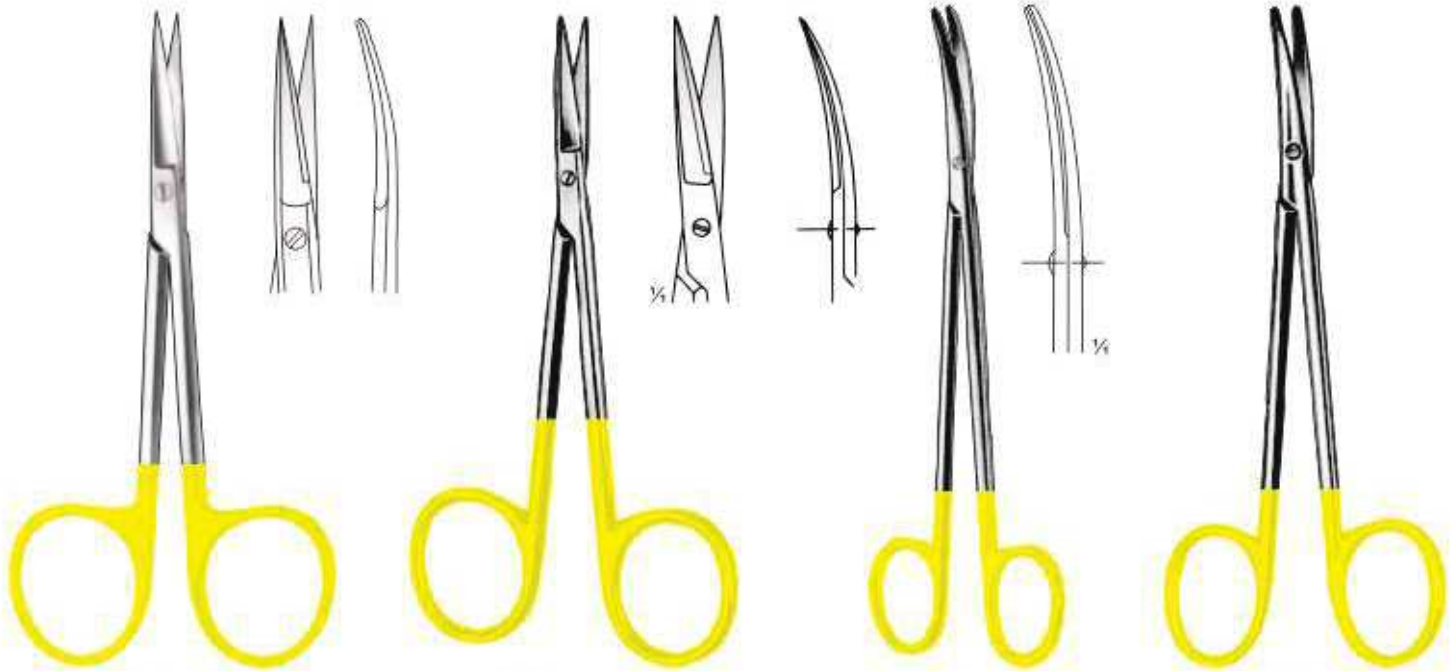

**IRIS**  
**Z-15-757-115**  
 11.5cm 4 1/2"

**IRIS**  
**Z-15-758-115**  
 11.5 cm Straight  
**Z-15-759-115**  
 11.5 cm Curved

**TOENNIS-ADSON**  
**Z-15-760-175**  
 17.5 cm, 6 3/4"

**STRABISMUS**  
**15-761-115**  
 11.5 cm, 4 1/2"  
 Curved

# DRESSING & TISSUE FORCEPS

- **DRESSING FORCEPS**
- **MICRO FORCEPS**
- **CILIA FORCEPS**

- **TISSUE FORCEPS**
- **SPLINTER FORCEPS**

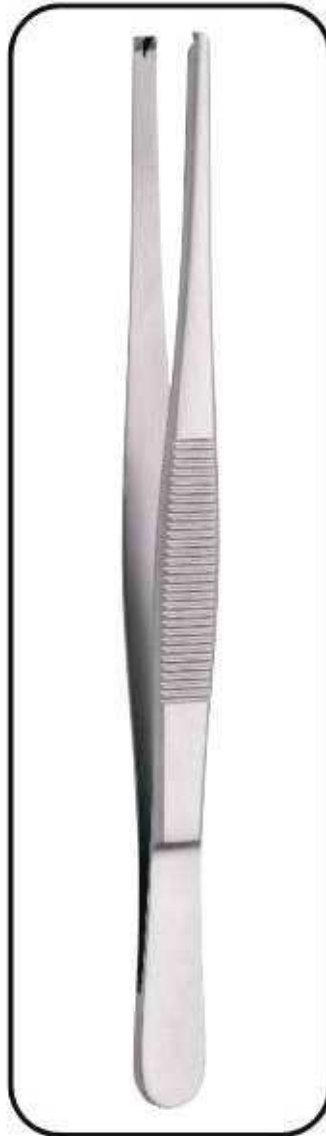
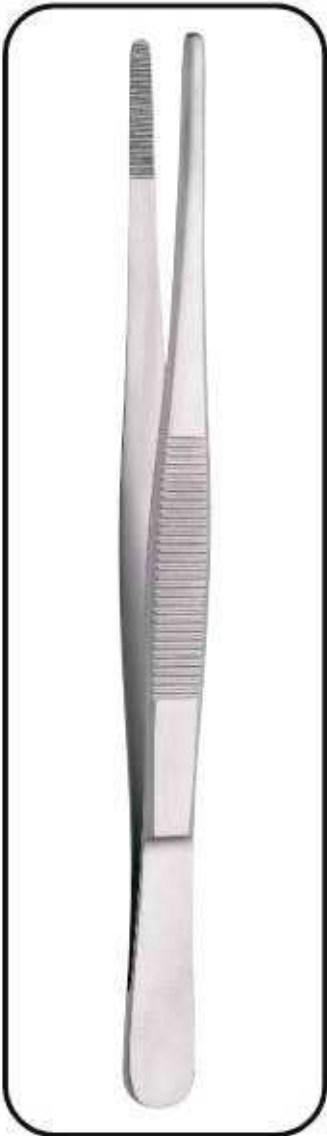

TISSUE & DRESSING FORCEPS

Pinces a tissu, Anatomische pinzetten  
Gewebe, Pinzas de disección

Pinzas para tejidos, Pincas à dissection  
Pinze per tessuti, Pinze per dissezione

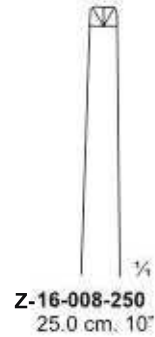
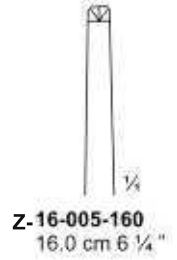
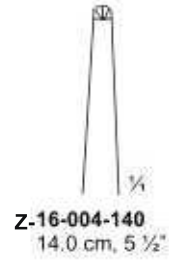
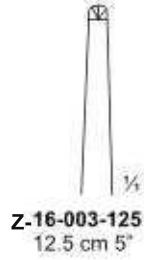
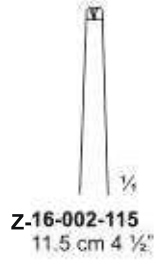
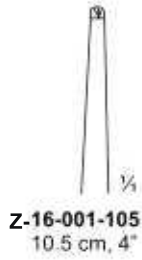

1:2  
STANDARD

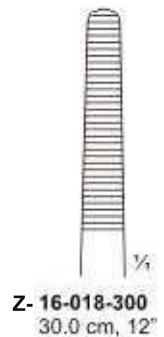
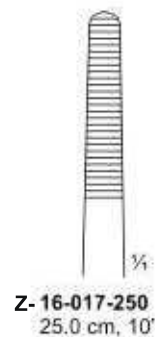
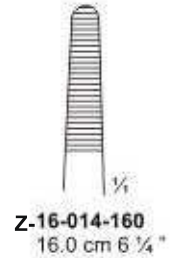
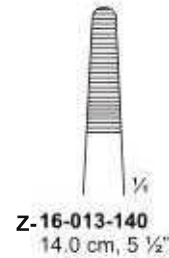

STANDARD





Mod.  
USA

**STANDARD**

- Z-16-019-120 12.0 cm, 4.5"
- Z-16-020-130 13.0 cm, 5"
- Z-16-021-145 14.5 cm, 5.5"
- Z-16-022-155 15.5 cm, 6"
- Z-16-023-180 18.0 cm, 7"
- Z-16-024-210 21.0 cm, 8"
- Z-16-025-250 25.0 cm, 10"
- Z-16-026-310 31.0 cm, 12"



Mod.  
USA

**STANDARD**

- Z-16-027-120 12.0 cm, 4.5"
- Z-16-028-130 13.0 cm, 5"
- Z-16-029-145 14.5 cm, 5.5"
- Z-16-030-155 15.5 cm, 6"
- Z-16-031-180 18.0 cm, 7"
- Z-16-032-210 21.0 cm, 8"
- Z-16-033-250 25.0 cm, 10"
- Z-16-034-310 31.0 cm, 12"

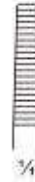

**STILLE**

- Z-16-035-150 15.0 cm, 6"



**MOD. MARTIN**

- Z-16-036-130 13.0 cm, 5"
- Z-16-037-145 14.5 cm, 5.5"



**STANDARD STRAIGHT**

- Z-16-038-115 11.5 cm, 4.5"
- Z-16-039-130 13.0 cm, 5"
- Z-16-040-145 14.5 cm, 5.5"
- Z-16-041-160 16.0 cm, 6"
- Z-16-042-180 18.0 cm, 7"
- Z-16-043-200 20.0 cm, 8"
- Z-16-044-250 25.0 cm, 10"
- Z-16-045-300 30.0 cm, 11.5"



**STANDARD CURVED**

- Z-16-046-115 11.5 cm, 4.5"
- Z-16-047-130 13.0 cm, 5"
- Z-16-048-145 14.5 cm, 5.5"
- Z-16-049-160 16.0 cm, 6"
- Z-16-050-180 18.0 cm, 7"
- Z-16-051-200 20.0 cm, 8"



**STANDARD**  
wide pattern cross serration

- Z-16-052-130 13.0 cm, 5"
- Z-16-053-145 14.5 cm, 5.5"
- Z-16-054-180 18.0 cm, 7"



**STANDARD NARROW**

- Z-16-055-130 13.0 cm, 5"
- Z-16-056-145 14.5 cm, 5 1/2"

Anatomische pinzetten  
 Pinzas de disección



**SEMKEN**

Z-16-057-125 12.5 cm, 5" Z-16-059-125 12.5 cm, 5"  
 Z-16-058-155 15.5 cm, 6" Z-16-060-155 15.5 cm, 6"

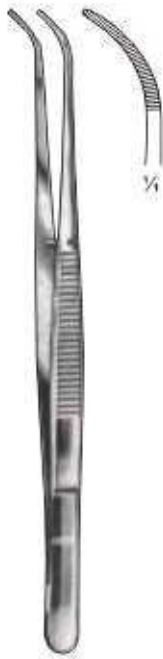

**SEMKEN**



**TAYLOR**

Z-16-061-175 17.5 cm 7"



**TAYLOR**

Z-16-062-175 17.5 cm 7"



**TAYLOR**

Z-16-063-175 17.5 cm 7"



**TAYLOR**

Z-16-064-175 17.5 cm 7"

16



**GERALD**

Z-16-065-180 18 cm, 7"



**GERALD**

Z-16-066-180 18 cm, 7"



**CUSHING**

Z-16-067-175 17.5 cm, 7"



**CUSHING**

Z-16-068-175 17.5 cm, 7"



**CUSHING 1:2**  
Z-16-069-175  
17.5 cm, 7"



**CUSHING 1:2**  
Z-16-070-175  
17.5 cm, 7"



**POTTS-SMITH 1:2**  
Z-16-071-180 18 cm, 7"  
Z-16-072-210 21 cm, 8"  
Z-16-073-250 25 cm, 10"



**POTTS-SMITH 1:2**  
Z-16-074-180 18 cm, 7"  
Z-16-075-210 21 cm, 8"  
Z-16-076-250 25 cm, 10"



**BROPHY 1:2**  
Z-16-077-200  
20 cm, 8"



**BROPHY 1:2**  
Z-16-078-200  
20 cm, 8"



**POTTS-SMITH**  
Z-16-079-180 18 cm, 7"  
Z-16-080-210 21 cm, 8.5"  
Z-16-081-250 25 cm, 10"



**POTTS-SMITH**  
Z-16-082-180 18 cm, 7"  
Z-16-083-210 21 cm, 8.5"  
Z-16-084-250 25 cm, 10"



**BROPHY**  
Z-16-085-200  
20 cm, 8"



**BROPHY**  
Z-16-086-200  
20 cm, 8"



**WANGENSTEEN**  
Z-16-087-230  
23 cm, 9"



**GERALD 1:2**  
Z-16-088-170  
17 cm, 6.75"



**GERALD 1:2**  
Z-16-089-170  
17 cm, 6.75"

Pinces a tissu,  
Gewebe Pinzas

Pinzas para tejidos,  
Pinze per tessuti



**SEMKEN 1:2**  
Z-16-090-125 12.5 cm, 5"  
Z-16-091-150 15.0 cm, 6"



**SEMKEN 1:2**  
Z-16-092-125 12.5 cm, 5"  
Z-16-093-150 15.0 cm, 6"



**TAYLOR 1:2**  
Z-16-094-175 17.5 cm, 7"



**TAYLOR 1:2**  
Z-16-095-175 17.5 cm, 7"



**TAYLOR 1:2**  
Z-16-096-175 17.5 cm, 7"



**TAYLOR 1:2**  
Z-16-097-175 17.5 cm, 7"



**STONE 4:5**  
Z-16-098-150 15 cm, 6"



**LERCHE 5:6**  
Z-16-099-150 15 cm, 6"



**ADLERKREUTZ 2:3**  
Z-16-100-150 15 cm, 6"  
Z-16-101-200 20 cm, 8"



**ADLERKREUTZ 4:5**  
Z-16-102-150 15 cm, 6"  
Z-16-103-200 20 cm, 8"



**GILLIES 1:2**  
Z-16-104-150 15 cm, 6"



2:3

- Z-16-105-115 11.5 cm 4 1/2"
- Z-16-106-130 13.0 cm 5"
- Z-16-107-145 14.5 cm 5 1/2"
- Z-16-108-160 16.0 cm 6 1/4"
- Z-16-109-180 18.0 cm 7"
- Z-16-110-200 20.0 cm 8"
- Z-16-111-250 25.0 cm 10"
- Z-16-112-300 30.0 cm 12"



3:4

- Z-16-113-130 13 cm, 5"
- Z-16-114-145 14.5 cm, 5 1/2"
- Z-16-115-160 16 cm, 6 1/4"



4:5

- Z-16-116-130 13 cm, 5"
- Z-16-117-145 14.5 cm, 5 1/2"
- Z-16-118-160 16 cm, 6 1/4"



1:2

- Z-16-119-130 13 cm, 5"
- Z-16-120-145 14.5cm, 5 1/2"
- Z-16-121-160 16 cm, 6 1/4"
- Z-16-122-200 20 cm, 8"



1:2

- Z-16-123-130 13 cm, 5"
- Z-16-124-145 14.5 cm, 5 1/2"



1:2

- Z-16-125-130 13 cm, 5"
- Z-16-126-145 14.5 cm, 5 1/2"



STILLE 1:2

- Z-16-127-150 15 cm, 6"



STILLE 2:3

- Z-16-128-150 15 cm, 6"



1:2

- Z-16-129-120 12 cm, 4 3/4"
- Z-16-130-130 13 cm, 5"
- Z-16-131-145 14.5cm, 5 1/2"
- Z-16-132-155 15.5cm, 6"
- Z-16-133-185 18.5cm, 7 1/2"
- Z-16-134-210 21 cm, 8 1/4"
- Z-16-135-250 25 cm, 10"
- Z-16-136-300 30 cm, 12 1/4"



2:3

- Z-16-137-130 13. cm, 5"
- Z-16-138-145 14.5cm, 5 1/2"
- Z-16-139-155 15.5cm, 6"

MOD. USA



3:4

- Z-16-140-130 13 cm, 5"
- Z-16-141-145 14.5cm, 5 1/2"
- Z-16-142-155 15.5cm, 6"



4:5

- Z-16-143-130 13 cm, 5"
- Z-16-144-145 14.5cm, 5 1/2"
- Z-16-145-155 15.5cm, 6"

# TISSUE & DRESSING FORCEPS **ZIANA** INDUSTRIES

Pinces a tissu, Anatomische pinzetten  
Gewebe, Pinzas de disección

Pinzas para tejidos, Pinces à dissection  
Pinze per tessuti, Pinze per dissezione



**MCINDOE**  
Z-16-146-150 15.0 cm, 6"  
Dissecting Forceps  
non-toothed,  
serrated jaws.

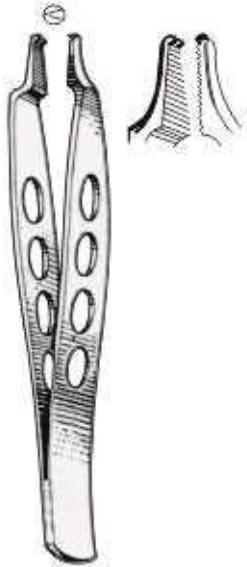

**JEAN 1:2**  
Z-16-147-140 14.0 cm, 5 1/2"  
Z-16-148-180 18.0 cm, 7"  
Dissecting Forceps  
one into two teeth on  
serrated jaws.



**WUAUGH 1:2**  
Z-16-149-150 15.0 cm, 6"  
Z-16-150-180 18.0 cm, 7"  
Dissecting Forceps  
slightly heavier  
non-toothed,  
serrated jaws.



**WUAUGH 1:2**  
Z-16-151-150 15.0 cm, 6"  
Z-16-152-180 18.0 cm, 7"  
Dissecting Forceps  
as above but one  
two tooth on  
serrated jaws.  
Known as Scott.



**LEEDHAM 1:2**  
Z-16-153-145 14.5 cm, 5.75"  
Z-16-154-180 18.0 cm, 7"  
Green Dissecting  
Forceps  
two three teeth, smooth jaws.



**TREVES 1:2**  
Z-16-155-125 12.5 cm, 5"  
Z-16-156-150 15.0 cm, 6"  
Z-16-157-180 18.0 cm, 7"  
Dissecting Forceps  
teeth, on smooth jaws.



**CHARNLEY 1:2**  
Z-16-158-145 14.5 cm, 5 1/4"  
Z-16-159-180 18.0 cm, 7"  
Z-Dissecting Forceps  
one into two teeth,  
block on jaws.

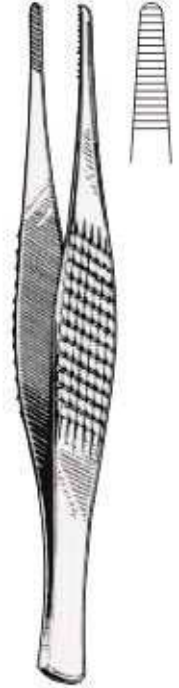

**RAMSAY**  
Z-16-160-180 18.0 cm, 7"  
Z-Dissecting Forceps  
Z-non-too serrated jaws.

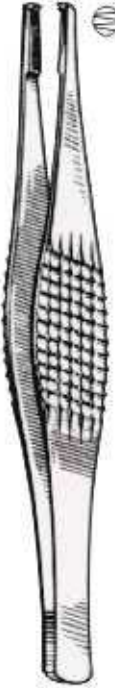

**RAMSAY 1:2**  
Z-16-161-180 18.0 cm, 7"  
Dissecting Forceps  
one into teeth on  
serrated jaws.  
As above but into  
three teeth.



Z-16-162-125 12.5 cm, 5"  
Z-16-163-150 15.0 cm, 6"  
Z-16-164-180 18.0 cm, 7"  
Dissecting Forceps  
turn over end,  
serrated jaws.



Z-16-165-125 12.5 cm, 5"  
Z-16-166-150 15.0 cm, 6"  
Z-16-167-180 18.0 cm, 7"  
Z-16-168-200 20.0 cm, 8"  
Dissecting Forceps  
block end, serrated  
jaws.



**FERRIS-SMITH 1:2**  
Z-16-169-180  
18 cm, 7"



**FERRIS-SMITH 1:2**  
Z-16-170-180  
18 cm, 7"



**LANE 1:2**  
Z-16-171-125 12.5cm, 5 1/2"  
Z-16-172-150 15 cm, 6"  
Z-16-173-170 17 cm, 6 3/4"  
Z-16-174-180 18 cm, 7"  
Z-16-175-200 20 cm, 8"



**LANE 2:3**  
Z-16-176-125 12.5cm, 5 1/2"  
Z-16-177-150 15 cm, 6"  
Z-16-178-170 17 cm, 6 3/4"  
Z-16-179-180 18 cm, 7"  
Z-16-180-200 20 cm, 8"



**BONNEY 1:2**  
Z-16-181-180  
18 cm, 7"



**BONNEY 2:3**  
Z-16-182-180  
18 cm, 7"



**DURANTE**  
Z-16-183-145 14.5cm, 5 1/2"  
Z-16-184-160 160 cm, 6 1/4"  
Z-16-185-200 20 cm, 8"



**NELSON**  
Z-16-186-230  
23 cm, 9"



**STILLE-BARRAYA 3:4**  
Z-16-187-180 18 cm, 7"  
Z-16-188-200 20 cm, 8"  
Z-16-189-250 25 cm, 10"



**FERRIS-SMITH 1:2**  
Z-16-190-180  
18 cm, 7"



**FERRIS-SMITH 2:3**  
Z-16-191-180  
18 cm, 7"

**TISSUE & DRESSING FORCEPS** **ZIANA INDUSTRIES**

*Pinces a tissu, Anatomische pinzetten  
Gewebe, Pinzas de disección*

*Pinzas para tejidos, Pinces à dissection  
Pinze per tessuti, Pinze per dissezione*

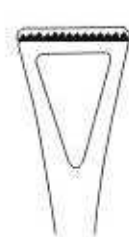
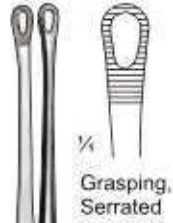
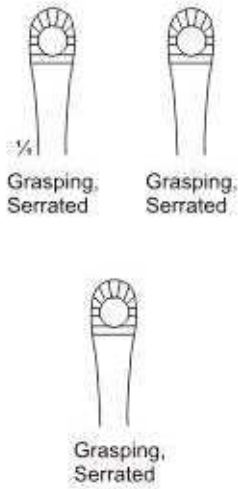

Z-16-197-200  
20 cm, 8"

Z-16-198-200  
20 cm, 8"



Z-16-199-200  
20 cm, 8"

**RUSSIAN-MODELL**

- Z-16-192-150 15 cm, 5 3/4"
- Z-16-193-200 20 cm, 8"
- Z-16-194-250 25 cm, 10"

**SINGLE-TUTTLE**

- Z-16-195-230  
23 cm, 9"

**SINGLE-TUTTLE  
INTESTINAL**

- Z-16-196-230  
23 cm, 9"

**COLLIN-DUVAL**

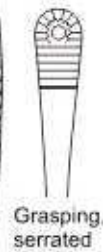
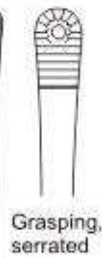

**DUEHRSSSEN**

- Z-16-200-200  
20 cm, 8"

**DUEHRSSSEN 1:2**

- Z-16-201-200  
20 cm, 8"

**DUEHRSSSEN 2:3**

- Z-16-202-200  
20 cm, 8"

**DUEHRSSSEN 3:4**

- Z-16-203-200  
20 cm, 8"

**DUEHRSSSEN**

- Z-16-204-200  
20 cm, 8"

**MAYO-RUSSIAN**

- Z-16-205-155  
15.5cm, 6"
- Z-16-206-230  
23.0cm, 9"

**DAVIS**

- Z-16-207-250  
25 cm, 10"



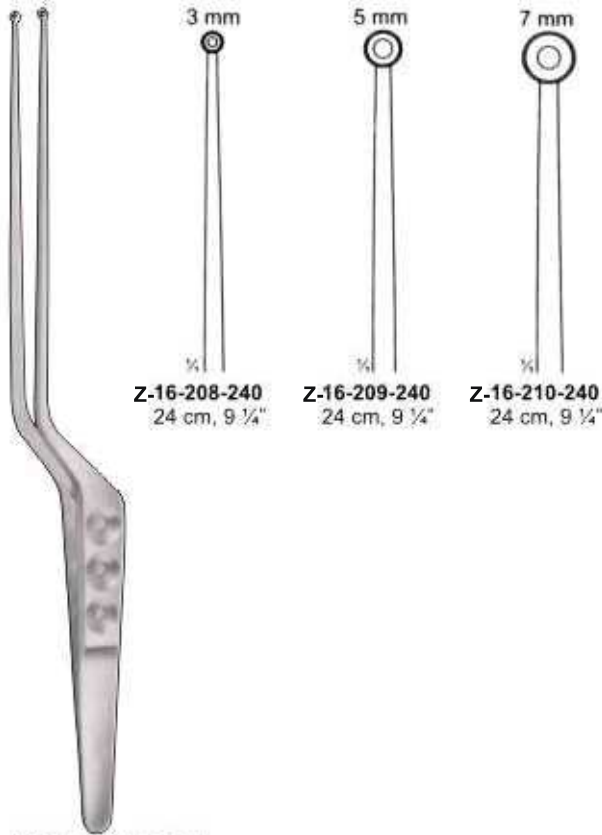

**Z-16-208-240**  
24 cm, 9 1/4"

**Z-16-209-240**  
24 cm, 9 1/4"

**Z-16-210-240**  
24 cm, 9 1/4"

**YASARGIL-SAMI**  
Jaws Spoon-Shaped  
24 cm, 9 1/4"

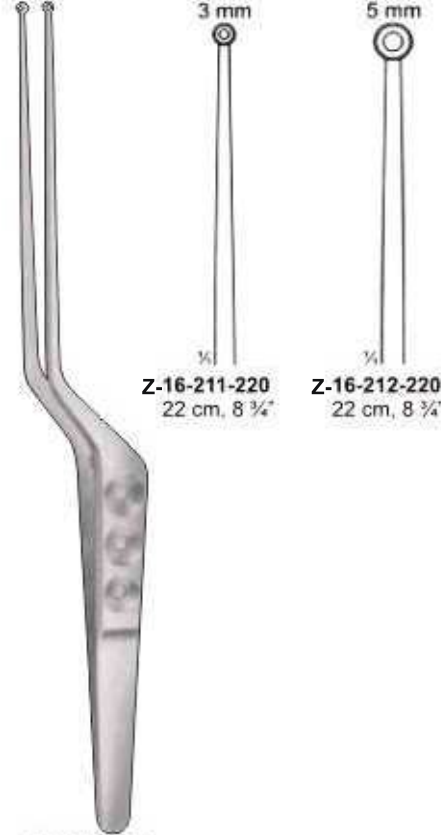

**Z-16-211-220**  
22 cm, 8 3/4"

**Z-16-212-220**  
22 cm, 8 3/4"

**YASARGIL**  
Jaws Spoon-Shaped  
22 cm, 8 3/4"

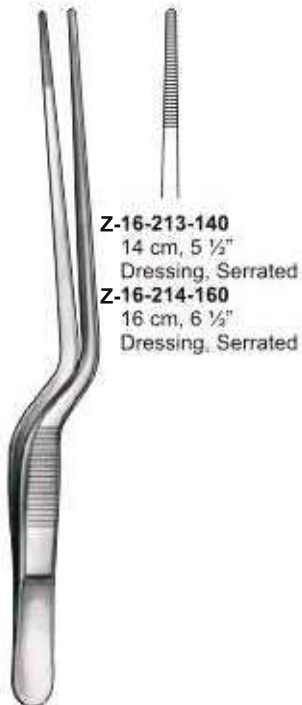

**Z-16-213-140**  
14 cm, 5 1/2"  
Dressing, Serrated  
**Z-16-214-160**  
16 cm, 6 1/2"  
Dressing, Serrated

**LUCAE / ENT**

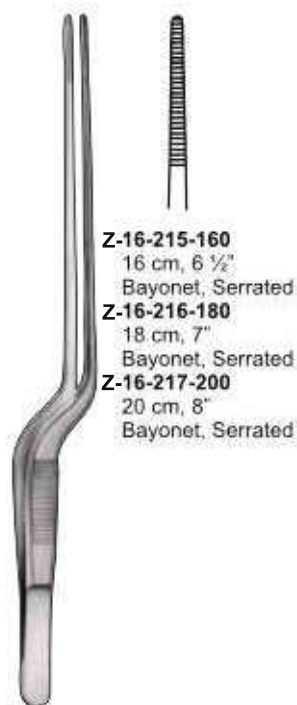

**Z-16-215-160**  
16 cm, 6 1/2"  
Bayonet, Serrated  
**Z-16-216-180**  
18 cm, 7"  
Bayonet, Serrated  
**Z-16-217-200**  
20 cm, 8"  
Bayonet, Serrated

**JANSSEN-GRUENWALD**



**MILLER**  
**Z-16-218-150**  
15 cm, 6"

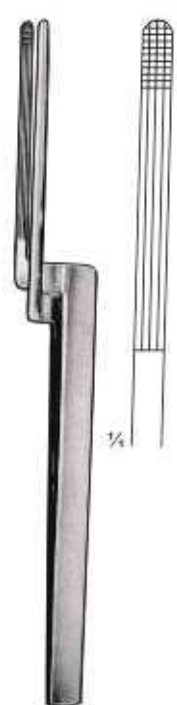

**MILLER**  
**Z-16-219-150**  
15 cm, 6"

Pinces a tissu.  
Gewebe



**HUNT**  
Z-16-220-200  
20 cm, 8"  
Tumor-and Vessel Forceps

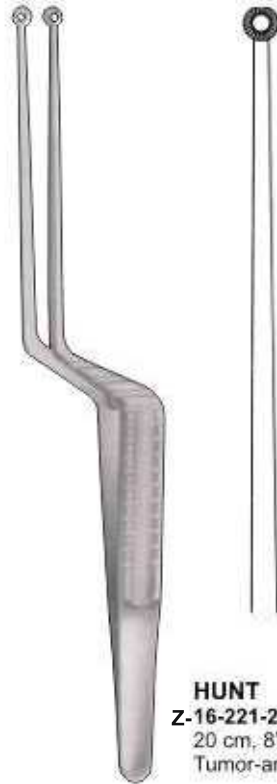

**HUNT**  
Z-16-221-200  
20 cm, 8"  
Tumor-and Vessel Forceps

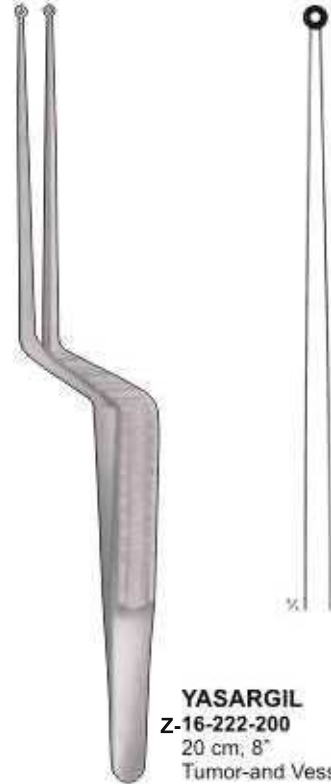

**YASARGIL**  
Z-16-222-200  
20 cm, 8"  
Tumor-and Vessel Forceps



**SAMII**  
23 cm, 9"  
Jaws Spoon-Shaped

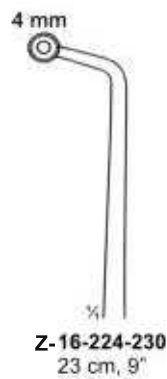

Z-16-224-230  
23 cm, 9"

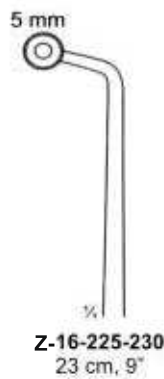

Z-16-225-230  
23 cm, 9"



**SAMII**  
23 cm, 9"  
Jaws Spoon-Shaped

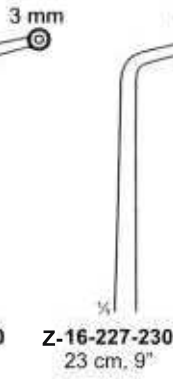

Z-16-227-230  
23 cm, 9"



Z-16-228-230  
23 cm, 9"



**Z-16-229-120**  
12 cm, 5"  
Tissue, 7:7 Teeth

**Z-16-230-120**  
12 cm, 5"  
Tissue, 9:9 Teeth



**9:9**



**16-232-150**  
15 cm, 6"  
Straight, 9:9 Teeth

**ADSON-BROWN**

**ADSON-BROWN**  
Z-16-231-120 12 cm, 5"

**BROWN**



**Z-16-233-120**  
12 cm, 5"  
Dressing, serrated

**Z-16-236-120**  
12 cm, 5"  
Tissue,  
1:2 Teeth

**Z-16-234-120**  
12 cm, 5"  
Dressing,  
Micro serrated

**Z-16-237-120**  
12 cm, 5"  
Tissue, Micro 1:2 Teeth  
**Z-16-238-120**  
12 cm, 5"  
Tissue, 2:3 Teeth

**Z-16-235-120**  
12 cm, 5"  
Dressing, serrated  
tungsten carbide



**Z-16-239-120**  
12 cm, 5"  
Dressing, Serrated

**Z-16-240-120**  
12 cm, 5"  
Tissue, 1:2 Teeth

**ADSON /  
MICRO-ADSON**

**EWALD / HUDSON**

Pinces a tissu, Anatomische pinzetten  
 Gewebe, Pinzas de disección

Pinzas para tejidos, Pince à dissection  
 Pinze per tessuti, Pinze per dissezione



**Z-16-241-120**  
 12 cm, 5"  
 Dressing,  
 Micro serrated

**Z-16-242-120**  
 12 cm, 5"  
 Tissue,  
 Micro-1:2 Teeth

**Z-16-243-120**  
 12 cm, 5"  
 Tissue, 1:2 Teeth



**DE BAKKEY /  
 LIGHTWEIGHT**  
**Z-16-244-160**  
 16 cm, 6 1/2"



**DE BAKKEY**

1.5mm  
**Z-16-245-160**  
 16 cm, 6 1/2"

2.0mm  
**Z-16-246-160**  
 16 cm, 6 1/2"

2.0mm  
**Z-16-247-160**  
 16 cm, 6 1/2"

**LIGHTWEIGHT-  
 ADSON**



**Z-16-248-145**  
 14.5 cm, 6"

**MODELL USA**



**Z-16-249-145**  
 14.5 cm, 6"  
 1:2 teeth

**MODELL USA**



**MCINDOE**  
**Z-16-250-150**  
 15 cm, 6"

**GILLIES**  
**Z-16-251-150**  
 15 cm, 6"  
 1:2 teeth



2.7 mm

**DEBAKEY**

- Z-16-252-150 15cm 6"
- Z-16-253-200 20cm 8"
- Z-16-254-240 24cm 9 1/2"
- Z-16-255-300 30cm 12"



3.5 mm

**DEBAKEY**

- Z-16-256-150 15cm 6"
- Z-16-257-200 20cm 8"
- Z-16-258-240 24cm 9 1/2"
- Z-16-259-300 30cm 12"



2 mm

**COOLEY**

- Z-16-260-150 15cm 6"
- Z-16-261-200 20cm 8"
- Z-16-262-240 24cm 9 1/2"
- Z-16-263-300 30cm 12"



1.2 mm

- Z-16-264-180 18 cm, 7"
- Z-16-265-210 21 cm, 8 1/4"

2 mm

- Z-16-266-180 18 cm, 7"
- Z-16-267-210 21 cm, 8 1/4"



- Z-16-268-160 16 cm, 6 1/2" 1.5 mm
- Z-16-269-200 20 cm, 8" 1.5 mm
- Z-16-270-240 24 cm, 9 1/2" 1.5 mm



- Z-16-275-160 16 cm, 6 1/2" 2.7mm
- Z-16-276-200 20 cm, 8" 2.7mm
- Z-16-277-200 20 cm, 8" 2.7mm Heavy
- Z-16-278-240 24 cm, 9 1/2" 2.7mm
- Z-16-279-305 30.5 cm, 12" 2.7mm

**DEBAKEY**



- Z-16-271-160 16 cm, 6 1/2" 2.0mm
- Z-16-272-200 20 cm, 8" 2.0mm
- Z-16-273-240 24 cm, 9 1/2" 2.0mm
- Z-16-274-305 30.5 cm, 12" 2.0mm



- Z-16-280-160 16 cm, 6 1/2" 3.5mm
- Z-16-281-200 20 cm, 8" 3.5mm
- Z-16-282-240 24 cm, 9 1/2" 3.5mm
- Z-16-283-305 30.5 cm, 12" 3.5mm



**DE BAKEY**



- Z-16-284-160 16 cm, 6 1/2"

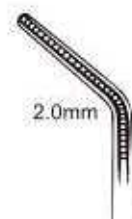

- Z-16-285-200 20 cm, 8"

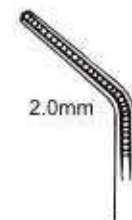

- Z-16-286-240 24 cm, 9 1/2"

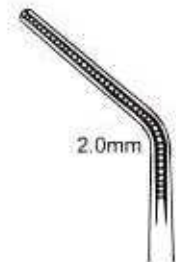

- Z-16-287-300 30 cm, 12"



**MICRO FORCEPS**  
Z-16-288-140 1:2  
14.0 cm, 5 1/2"



**MICRO FORCEPS**  
Z-16-289-140 1:2  
14.0 cm, 5 1/2"



**MICRO FORCEPS**  
Z-16-290-140 14.0 cm, 5 1/2"  
Z-16-291-180 18.0 cm, 7"

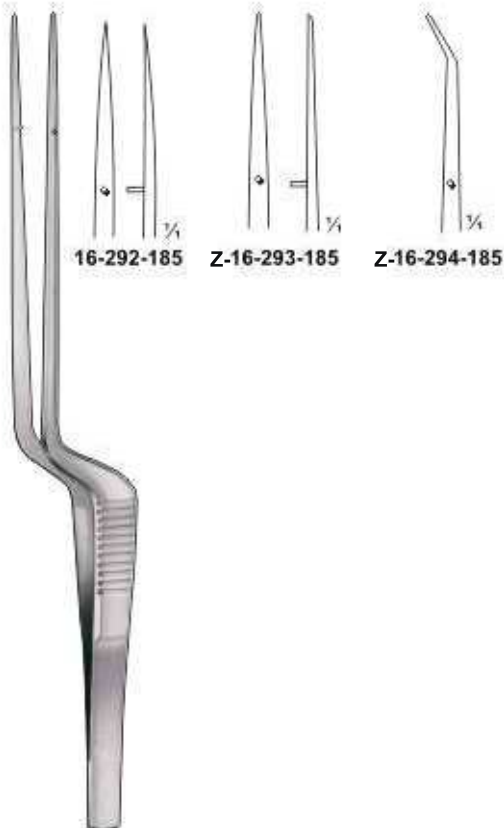

Z-16-292-185    Z-16-293-185    Z-16-294-185

**MICRO FORCEPS**  
18.5cm, 7 1/4"



Z-16-295-225    Z-16-296-225

**MICRO FORCEPS**  
22.5cm, 9"



**MICRO FORCEPS**  
Z-16-297-140 14.0 cm, 5 1/2"



**STEVENS**  
10.5cm, 4"



**Z-16-298-105**  
Straight



**Z-16-299-105**  
Curved



**Z-16-300-105**  
Curved



**Z-16-301-105**  
Straight



**Z-16-302-105**  
Curved



**Z-16-303-105**  
Curved



**MICRO FORCEPS**



0.3 mm  
**Z-16-304-120**  
12.0cm, 5"  
Straight



0.3 mm  
**Z-16-305-150**  
15.0cm, 6"  
Curved



**MICRO FORCEPS**  
18.0 cm, 7"



**Z-16-306-180**  
Straight



**Z-16-307-180**  
Curved

Pinces a tissu, Anatomische pinzetten  
Gewebe, Pinzas de disección

Pinzas para tejidos, Pinces à dissection  
Pinze per tessuti, Pinze per dissezione



**GRAEFE**

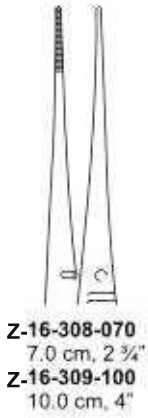

**Z-16-308-070**  
7.0 cm, 2 3/4"  
**Z-16-309-100**  
10.0 cm, 4"

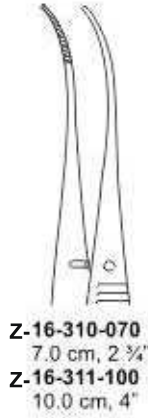

**Z-16-310-070**  
7.0 cm, 2 3/4"  
**Z-16-311-100**  
10.0 cm, 4"

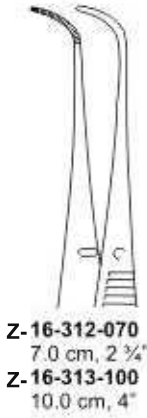

**Z-16-312-070**  
7.0 cm, 2 3/4"  
**Z-16-313-100**  
10.0 cm, 4"

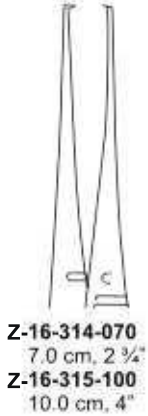

**Z-16-314-070**  
7.0 cm, 2 3/4"  
**Z-16-315-100**  
10.0 cm, 4"

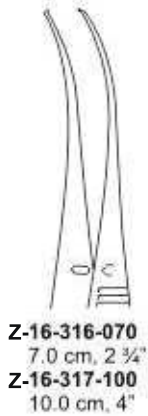

**Z-16-316-070**  
7.0 cm, 2 3/4"  
**Z-16-317-100**  
10.0 cm, 4"

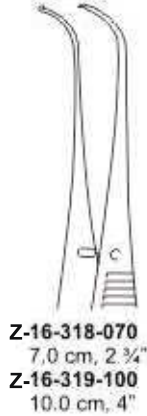

**Z-16-318-070**  
7.0 cm, 2 3/4"  
**Z-16-319-100**  
10.0 cm, 4"



**STEVENS 1:2**

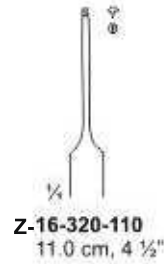

**Z-16-320-110**  
11.0 cm, 4 1/2"



**STEVENS 1:2**

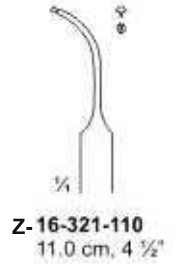

**Z-16-321-110**  
11.0 cm, 4 1/2"



**GRAEFE**

**Z-16-322-070** 0.5 mm  
**Z-16-323-070** 0.7 mm  
**Z-16-324-070** 1.0 mm  
7.0 cm, 3"



**GRAEFE**

**Z-16-325-070** 0.5 mm  
**Z-16-326-070** 0.7 mm  
**Z-16-327-070** 1.0 mm  
7.0 cm, 3"



**GRAEFE 1:2**

**Z-16-328-070** 0.5 mm  
**Z-16-329-070** 0.7 mm  
**Z-16-330-070** 1.0 mm  
7.0 cm, 3"



**GRAEFE 1:2**

**Z-16-331-070** 0.5 mm  
**Z-16-332-070** 0.7 mm  
**Z-16-333-070** 1.0 mm  
7.0 cm, 3"





**JEWELER TYPE, DISSECTING FORCEPS**

Chirurgische pinzetten, Uhrmacher-Pinzetten  
Pinzas de disección con dientes, Pinzas de relojero

Pinces à dissection à groffes, Pinces d'horloger  
Pinze per dissezione con denti, Pinze de orologiaio



**JEWELER'S FORCEPS**  
Z-16-334-115 11.5 cm, 4 1/2"



Z-16-335-105  
10.5 cm, 4"



Z-16-336-105  
10.5 cm, 4"



Z-16-337-110  
11 cm, 4 1/2"



Z-16-338-110  
11 cm, 4 1/2"



Z-16-339-110  
11 cm, 4 1/2"



Z-16-340-120  
12 cm, 5"



Z-16-341-120  
12 cm, 5"



Z-16-342-120  
12 cm, 5"



Jewelers Forceps

Z-16-343-001



Jewelers Forceps

Z-16-344-002



Jewelers Forceps

Z-16-345-003



Jewelers Forceps

Z-16-346-004



Jewelers Forceps

Z-16-347-005



Jewelers Forceps

Z-16-348-006



Jewelers Forceps

Z-16-349-007



Jewelers Forceps

Z-16-350-008

*Cilienpinzetten*  
*Pinzas depilatorias*

*Pinces à épiler les cils*  
*Pinze depilatoria*



**ZIEGLER**  
**Z-16-351-090**  
 9 cm, 3 1/2"



**DOUGLAS**  
**Z-16-352-090**  
 9 cm, 3 1/2"

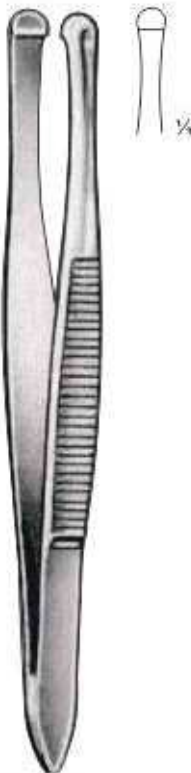

**BEER**  
**Z-16-353-090**  
 9 cm, 3 1/2"



**GRADLE**  
**Z-16-354-105**  
 10.5cm, 4"



**KUEHNE**  
**Z-16-355-105**  
 10.5cm, 4"



**KUEHNE**  
**Z-16-356-105**  
 10.5cm, 4"



**BARRAQUER**  
**Z-16-357-105**  
 10.5cm, 4"



**LITTAUER**  
**Z-16-358-085**  
 8.5 cm, 3"



**LITTAUER**  
**Z-16-359-090**  
 9 cm, 3 1/2"



Z-16-360-080 8 cm, 3"  
Z-16-361-090 9 cm, 3 1/2"  
Z-16-362-105 10.5 cm, 4"  
Z-16-363-115 11.5 cm, 4 1/2"  
Z-16-364-125 12.5 cm, 5"  
Z-16-365-145 14.5 cm, 5 1/2"  
Straight



Z-16-366-080 8 cm, 3"  
Z-16-367-090 9 cm, 3 1/2"  
Z-16-368-105 10.5 cm, 4"  
Z-16-369-115 11.5 cm, 4 1/2"  
Z-16-370-125 12.5 cm, 5"  
Z-16-371-145 14.5 cm, 5 1/2"  
Curved



Z-16-372-080 8 cm, 3"  
Z-16-373-090 9 cm, 3 1/2"  
Z-16-374-105 10.5 cm, 4"  
Z-16-375-115 11.5 cm, 4 1/2"  
Z-16-376-125 12.5 cm, 5"  
Z-16-377-145 14.5 cm, 5 1/2"  
Straight

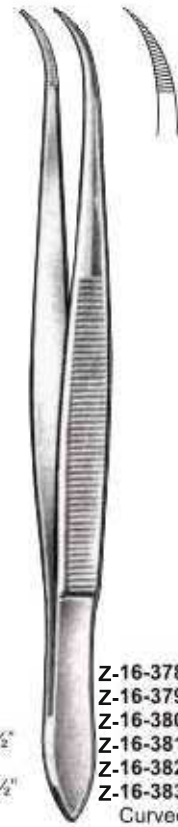

Z-16-378-080 8 cm, 3"  
Z-16-379-090 9 cm, 3 1/2"  
Z-16-380-105 10.5 cm, 4"  
Z-16-381-115 11.5 cm, 4 1/2"  
Z-16-382-125 12.5 cm, 5"  
Z-16-383-145 14.5 cm, 5 1/2"  
Curved



Z-16-384-075 7.5 cm, 3"  
Z-16-385-090 9 cm, 3 1/2"  
Z-16-386-110 11 cm, 4"  
Straight

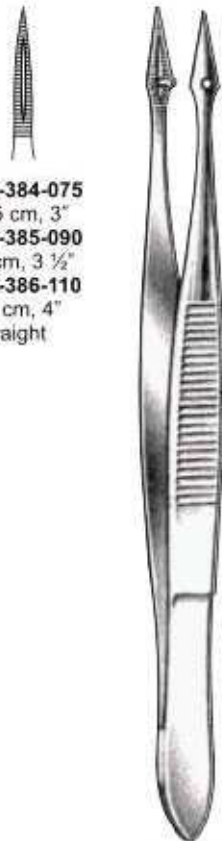

Z-16-387-105 10.5 cm, 4"  
Straight



Z-16-388-105 10.5 cm, 4"  
Curved



Z-16-389-105 10.5 cm, 4"  
Straight



Z-16-390-105 10.5 cm, 4"  
Curved

FEILCHENFELD

HUNTER

HUNTER

CARMALT

CARMALT

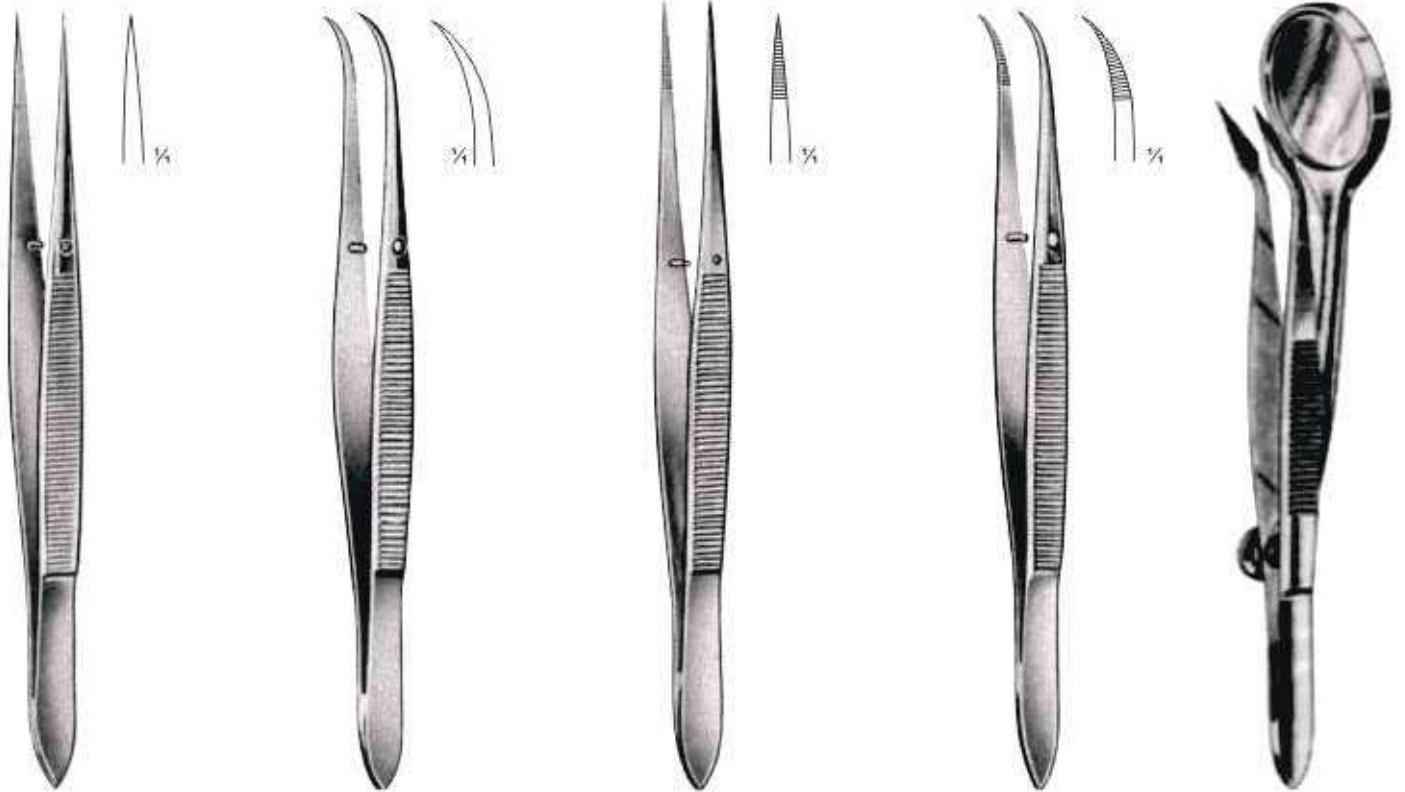

**Z-16-391-080** 8.0 cm, 3"  
**Z-16-392-090** 9.0 cm, 3 1/2"  
**Z-16-393-105** 10.5 cm, 4"  
**Z-16-394-115** 11.5 cm, 4 1/2"  
**Z-16-395-125** 12.5 cm 5"  
**Z-16-396-145** 14.5 cm 6"  
 Straight

**Z-16-397-080** 8.0 cm, 3"  
**Z-16-398-090** 9.0 cm, 3 1/2"  
**Z-16-399-105** 10.5 cm, 4"  
**Z-16-400-115** 11.5 cm, 4 1/2"  
**Z-16-401-125** 12.5 cm 5"  
**Z-16-402-145** 14.5 cm 6"  
 Curved

**Z-16-403-080** 8.0 cm, 3"  
**Z-16-404-090** 9.0 cm, 3 1/2"  
**Z-16-405-105** 10.5 cm, 4"  
**Z-16-406-115** 11.5 cm, 4 1/2"  
**Z-16-407-125** 12.5 cm 5"  
**Z-16-408-145** 14.5 cm 6"  
 Straight

**Z-16-409-080** 8.0 cm, 3"  
**Z-16-410-090** 9.0 cm, 3 1/2"  
**Z-16-411-105** 10.5 cm, 4"  
**Z-16-412-115** 11.5 cm, 4 1/2"  
**Z-16-413-125** 12.5 cm 5"  
**Z-16-414-145** 14.5 cm 6"  
 Curved

**STIEGLITZ**  
**FORCEPS**  
**Z-16-415-125**  
 12.5 cm, 5"



**STIEGLITZ**  
**Z-16-416-140** 14 cm, 5 1/2" Str.  
**Z-16-417-140** 14 cm, 5 1/2" Cvd.

**STIEGLITZ**  
**Z-16-418-140** 14 cm, 5 1/2" Str.  
**Z-16-419-140** 14 cm, 5 1/2" Cvd.

**PEET**  
**Z-16-420-115**  
 11.5 cm, 4 1/2"

**RALK**  
**Z-16-421-150** 15 cm, 6" Str.  
**Z-16-422-150** 15 cm, 6" Cvd.



**Z-16-423-130**  
13 cm, 5 1/4"



**Z-16-424-140**  
14 cm, 5 1/2"



**Z-16-425-160**  
16 cm, 6 1/4"



**Z-16-426-180**  
18 cm, 7"



**Z-16-427-200**  
20 cm, 8"



**Z-16-428-250**  
25 cm, 10"



STANDARD



**Z-16-429-140**  
14 cm, 5 1/2"



**Z-16-430-160**  
16 cm, 6 1/4"



**Z-16-431-180**  
18 cm, 7"



**Z-16-432-200**  
20 cm, 8"



**Z-16-433-250**  
25 cm, 10"



**Z-16-434-300**  
30 cm, 12"



STANDARD



**STANDARD**  
**Z-16-435-140** 14 cm, 5 1/2"  
**Z-16-436-160** 16 cm, 6 1/4"



ADSON

**Z-16-437-120**  
12 cm, 5"  
cross serration



**Z-16-438-120**  
12 cm, 5"  
cross serration-  
1:2 Teeth



**Z-16-439-150**  
15.0 cm, 6"  
cross serration-  
1:2 Teeth



**Z-16-440-120**  
12 cm, 5"  
Dressing,  
cross serration



**Z-16-441-120**  
12 cm, 5"  
Tissue, cross  
serration-1:2 Teeth



**TISSUE & DRESSING FORCEPS T.C. INSERTED**

*Pinces a tissu, Anatomische pinzetten  
Gewebe, Pinzas de disección*

*Pinzas para tejidos, Pinces à dissection  
Pinze per tessuti, Pinze per dissezione*



**CUSHING TISSUE  
FORCEPS**  
Z-16-442-178  
17.8 cm, 7"



**CUSHING**  
Z-16-443-180  
18 cm, 7"  
Cross Serrated



**CUSHING**  
Z-16-444-180  
18 cm, 7"



**DISSECTING  
TISSUE FORCEPS**  
Z-16-445-180  
18 cm, 7"



**ADSON**  
Z-16-446-120  
12 cm, 5"



**ADSON**  
Z-16-447-210  
21 cm, 8 1/2"

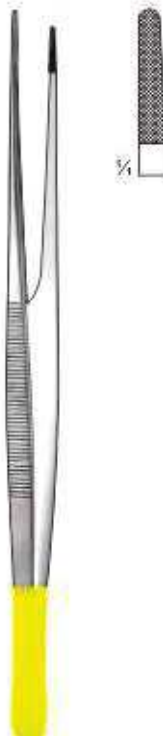

**RESANO**  
Z-16-448-250  
25 cm, 10"



**CUSHING TISSUE  
FORCEPS**  
16-449-190  
19 cm, 7 1/2"

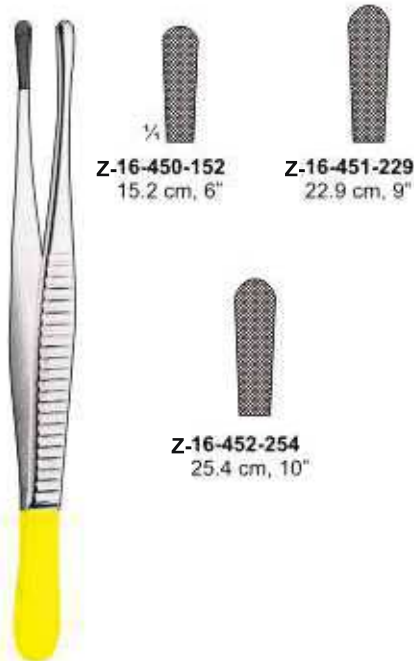

**WANGENSTEEN TISSUE  
FORCEPS**



**WANGENSTEEN**  
Z-16-453-150 15 cm, 6"  
Z-16-454-230 23 cm, 9"  
Z-16-455-250 25 cm, 10"



**DEBAKEY MICRO NEEDLE  
PULLING TISSUE FORCEPS**  
Z-16-456-184  
18.4 cm, 7"

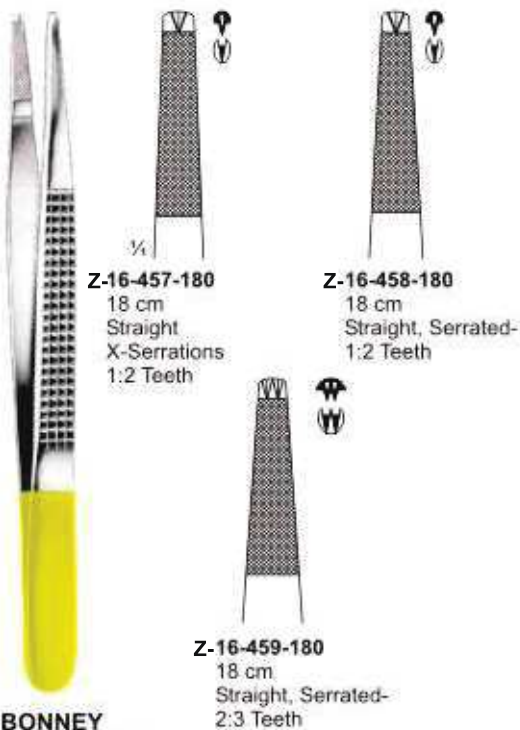

**BONNEY  
DISSECTING**



**POTTS-SMITH  
FORCEPS**  
Z-16-460-150 15 cm, 6"  
Z-16-461-180 18 cm, 7"  
Z-16-462-200 20 cm, 8"  
Z-16-463-230 23 cm, 9"  
Z-16-464-250 25 cm, 10"



**POTTS-SMITH**  
Z-16-465-160 16 cm, 6 1/2"  
Z-16-466-180 18 cm, 7"  
Z-16-467-210 21 cm, 8 1/2"  
Z-16-468-240 24 cm, 9 1/2"  
Z-16-469-260 26 cm, 10 1/2"



**POTTS-SMITH**  
Z-16-470-200  
20 cm, 8"

**DRESSING FORCEPS T.C. INSERTED**



Anatomische pinzetten  
Pinzas de disección

Pinces à dissection  
Pinze per dissezione



- Z-16-471-130 13 cm, 5"
- Z-16-472-140 14 cm, 5 1/2"
- Z-16-473-150 15 cm, 6"

- Z-16-474-180 18 cm, 7"
- Z-16-475-200 20 cm, 8"
- Z-16-476-250 25 cm, 10"

**TISSUE FORCEPS**

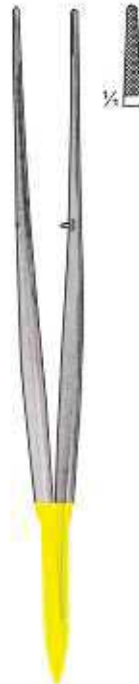

**CUSHING TISSUE FORCEPS**  
Z-16-477-178  
17.8 cm, 7"



**CUSHING**  
Z-16-478-180  
18 cm, 7"



**EVANS PELVIC NEEDLE TISSUE**  
Z-16-479-254  
25.4 cm, 10"



**EVANS**  
Z-16-480-250  
25 cm, 10"

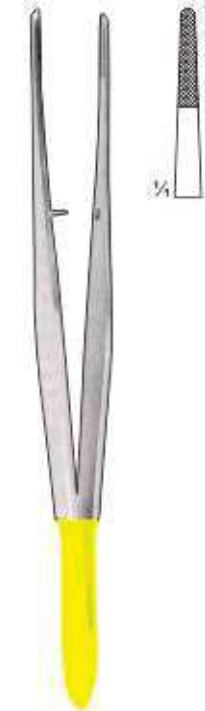

**TISSUE FORCEPS**  
Z-16-481-146  
14.6 cm, 6"



- **HAEMOSTATIC FORCEPS**
- **TOWEL CLAMPS**
- **TUBING FORCEPS**
- **SPONGE FORCEPS**

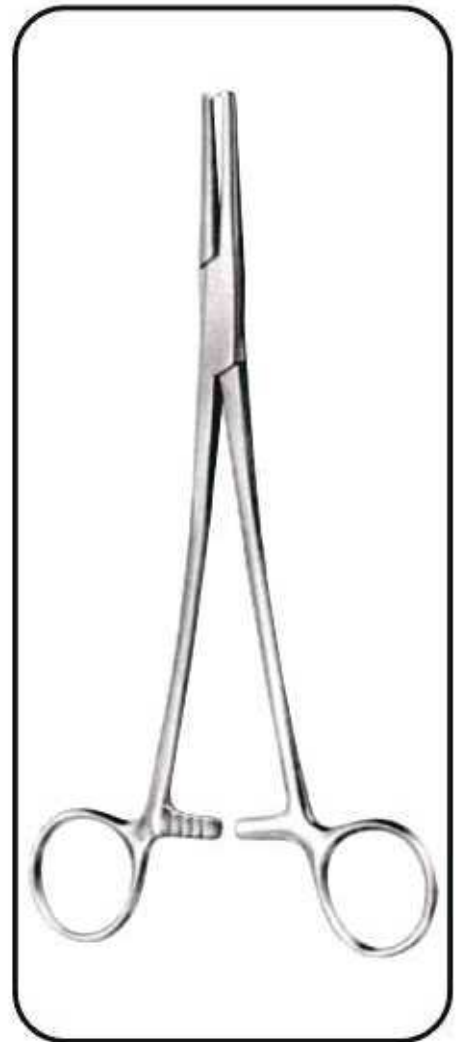

Arterienklemmen  
 Pinzas hemostaticas

Pinces hemostatiques  
 Pinze emostatiche



**CARREL**  
 Z-17-001-085  
 8.5 cm, 3 1/4"

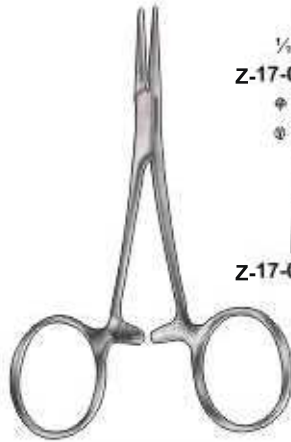

**BABY-MOSQUITO  
 (HARTMANN)**  
 10.0 cm, 4"

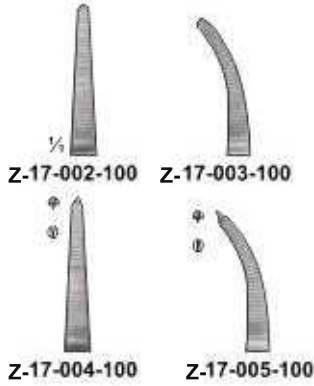

**MICRO-HALSTED**  
 12.5 cm, 5"

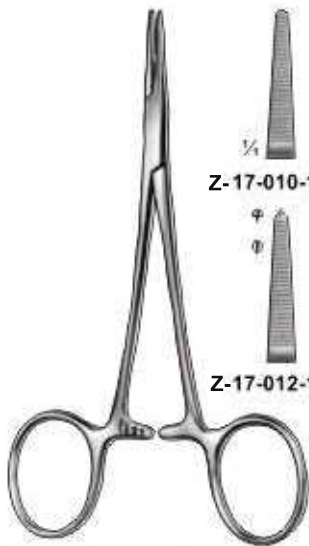
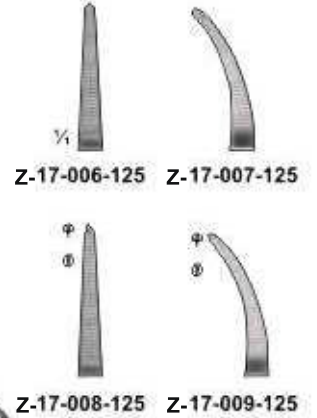

**HALSTED-MOSQUITO**  
 12.5 cm, 5"

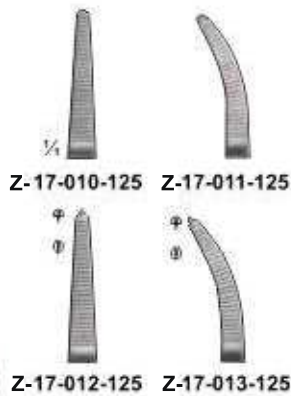

**PROVIDENCE-HOSPITAL**  
 14.0 cm, 5 1/2"

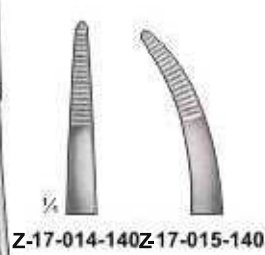

**KELLY**  
 14.0 cm, 5 1/2"

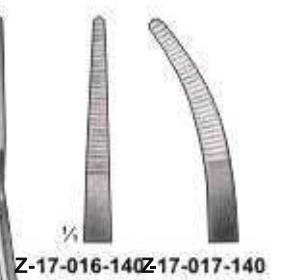

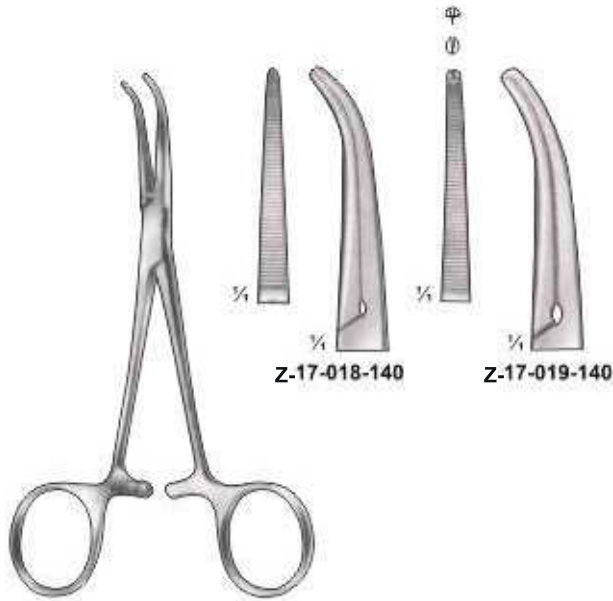

**DANDY**  
14.0 cm, 5 1/2"  
Curved sideways

Z-17-018-140

Z-17-019-140

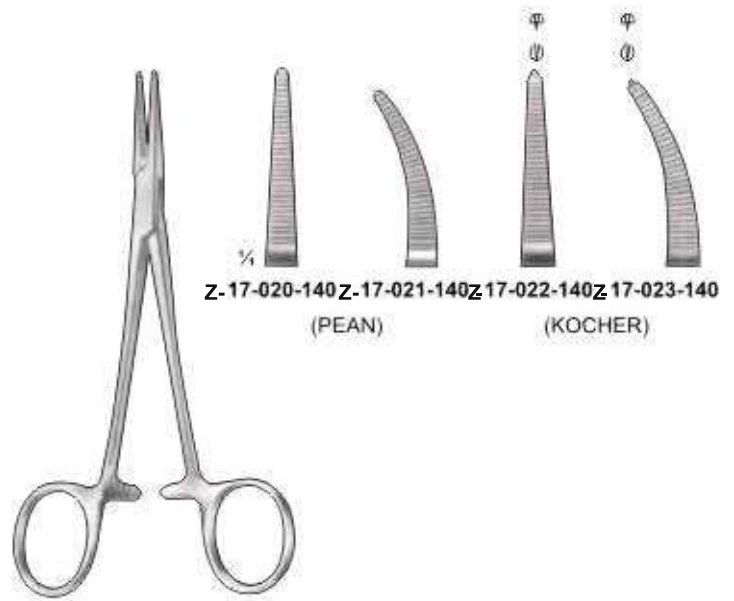

**BABY-CRILE**  
14.0 cm, 5 1/2"

Z-17-020-140 Z-17-021-140 Z-17-022-140 Z-17-023-140  
(PEAN) (KOCHER)



**CRILE**  
14.0 cm, 5 1/2"

Z-17-024-140 Z-17-025-140 Z-17-026-140 Z-17-027-140

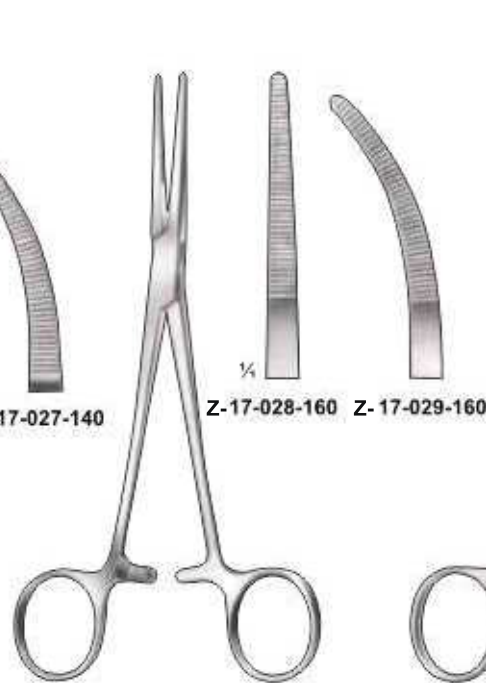

**RANKIN**  
16.0 cm, 6 1/4"

Z-17-028-160 Z-17-029-160

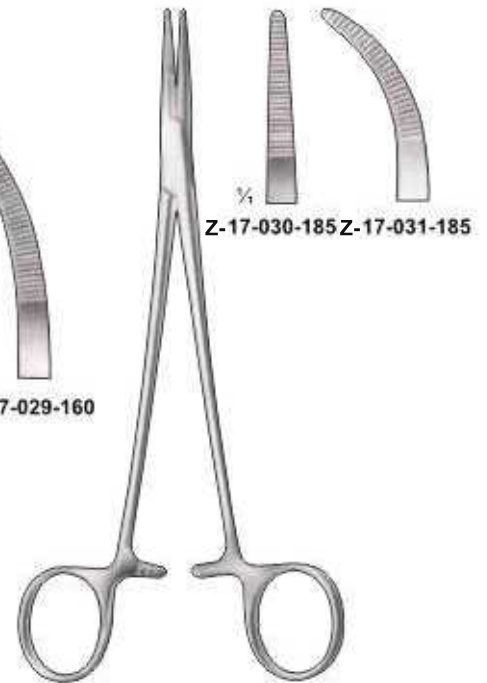

**ADSON**  
18.5 cm, 7 1/4"

Z-17-030-185 Z-17-031-185

Arterienklemmen  
 Pinzas hemostaticas

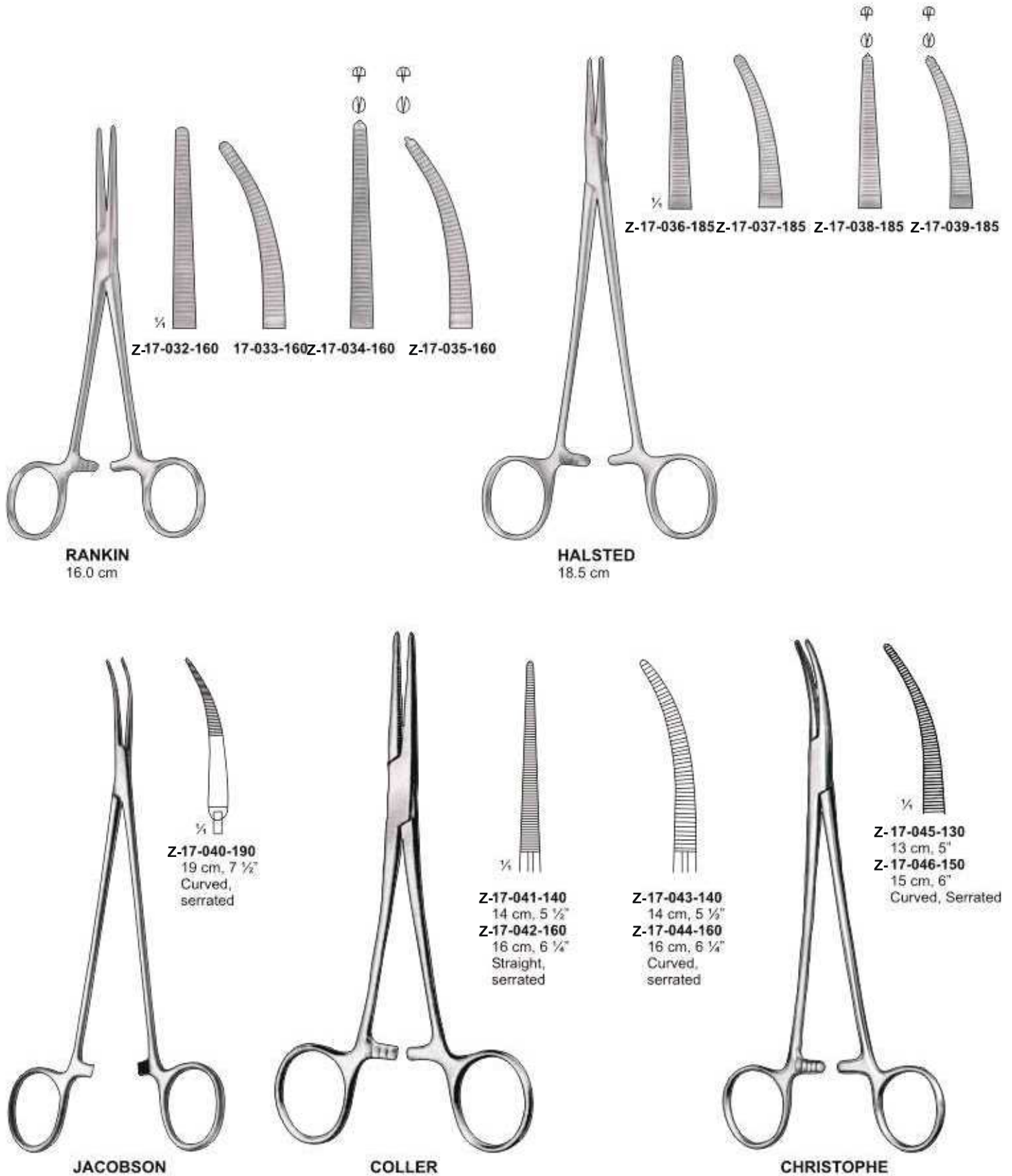

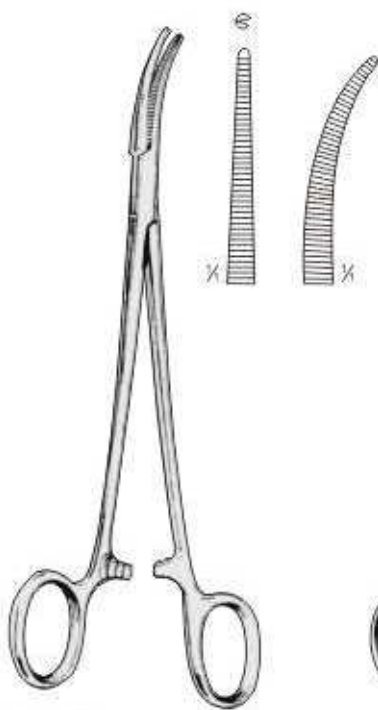

**ADSON**  
Z-17-047-180 18.0 cm, 7"  
Straight, box joint,  
as above but curved flat.  
Straight, box joint,  
one into two teeth



**ADSON 1:2**

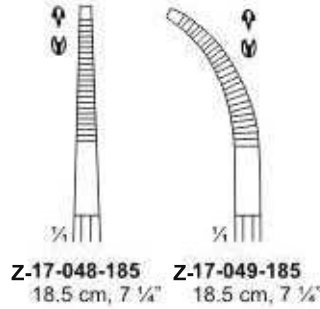

Z-17-048-185 18.5 cm, 7 1/4"  
Z-17-049-185 18.5 cm, 7 1/4"

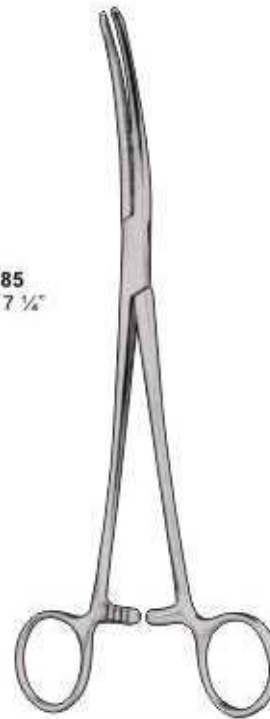

**SAROOT**

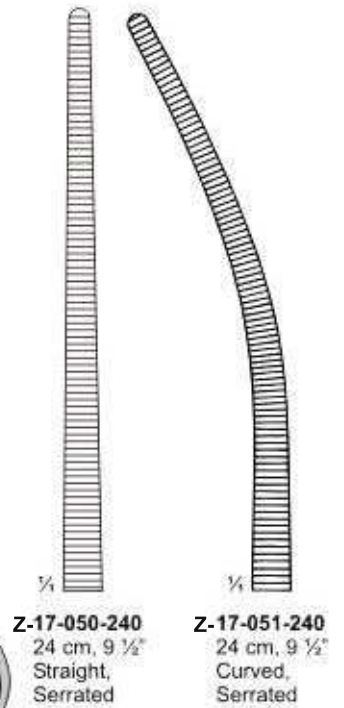

Z-17-050-240 24 cm, 9 1/2"  
Straight, Serrated  
Z-17-051-240 24 cm, 9 1/2"  
Curved, Serrated



**O'SHAUGHNESSY**

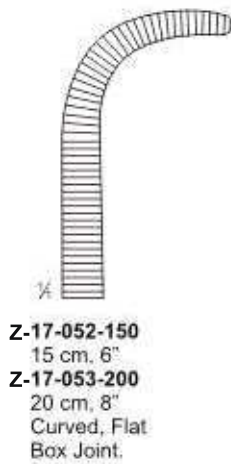

Z-17-052-150 15 cm, 6"  
Z-17-053-200 20 cm, 8"  
Curved, Flat  
Box Joint.



**GREY TURNER**



Z-17-054-145 14.5 cm, 5 3/4"  
Z-17-055-180 18 cm, 7"  
Straight  
Joint.

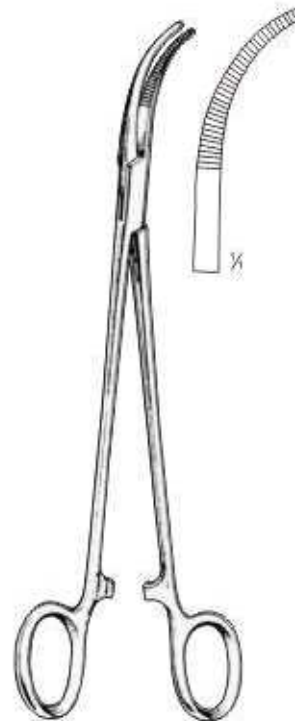

**SAWTELL**  
Z-17-056-185 18.5 cm, 7 1/4"  
curved on flat joint

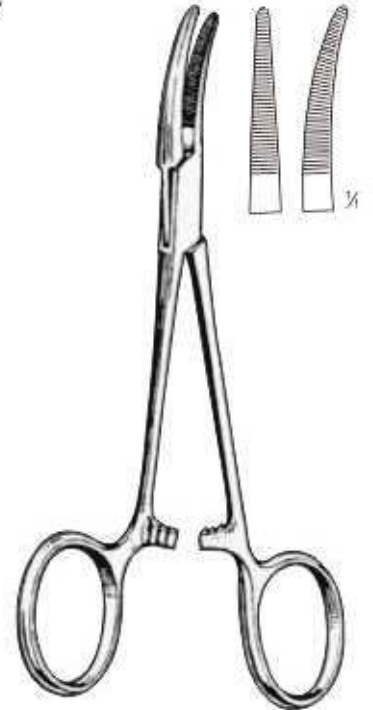

**DUNHILL**  
Z-17-057-130 13.0 cm, 5"  
Straight, box joint, as  
above but curved on flat.

Arterienklemmen  
 Pinzas hemostaticas

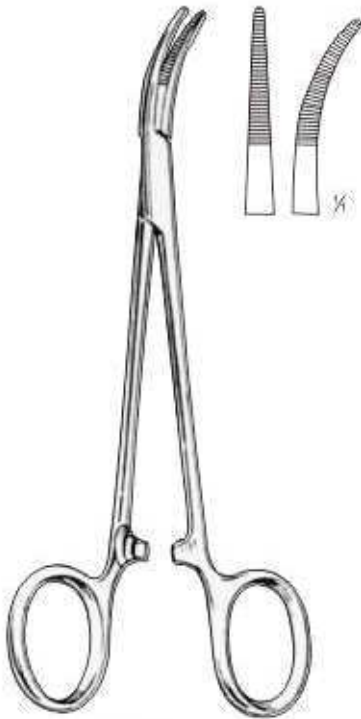

**CAIRNS**  
**Z-17-058-145**  
 14.5 cm, 5 3/4"  
 Straight, box joint, as  
 above but curved on flat.

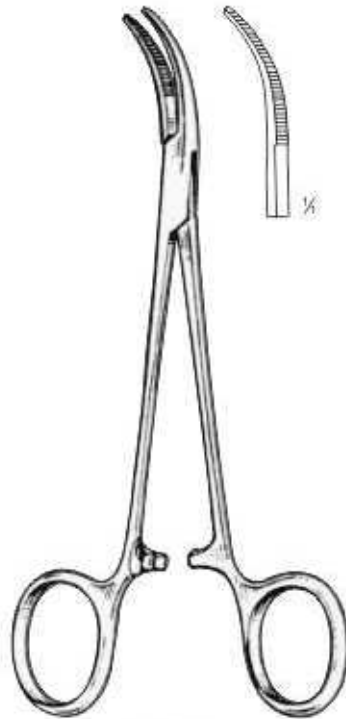

**CAIRNS**  
**Z-17-059-145**  
 14.5 cm, 5 3/4"  
 curved laterally,  
 joint



**Z-17-060-270**  
 27 cm, 10 3/4"  
 Right Angle,  
 Serrated

**MEEKER**



**Z-17-061-180**  
 18 cm, 7"  
 Curved,  
 Serrated

**SCHNIDT / SAWTELL**

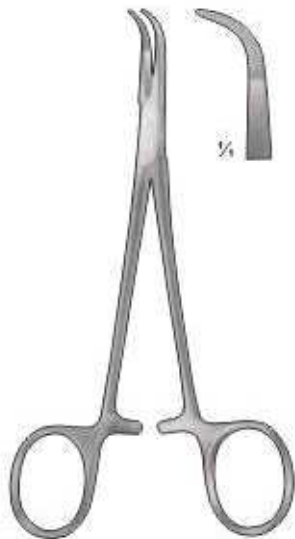

**MICRO-ADSON**  
**Z-17-062-140**  
 14.0 cm

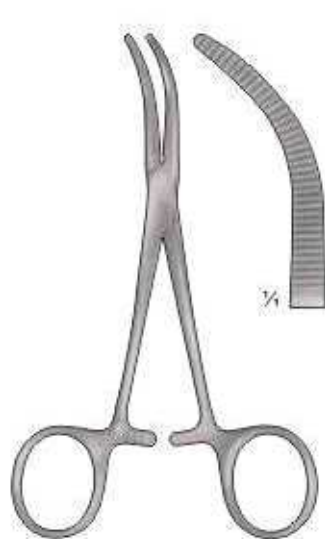

**BABY-OVERHOLT**  
**Z-17-063-135**  
 13.5 cm



**Z-17-064-140** 14.0 cm  
**17-065-180** 18.0 cm

**BABY-MIXER**

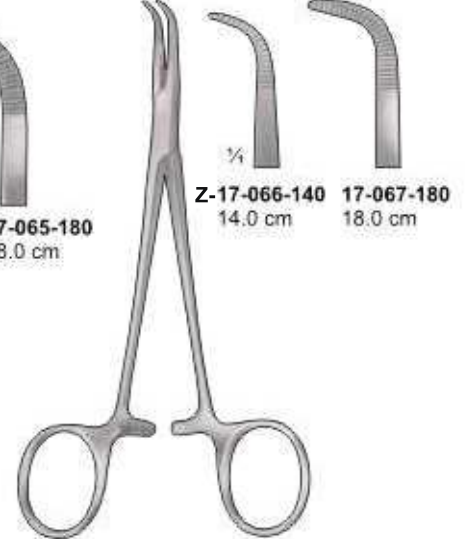

**Z-17-066-140** 14.0 cm  
**17-067-180** 18.0 cm

**BABY-ADSON**

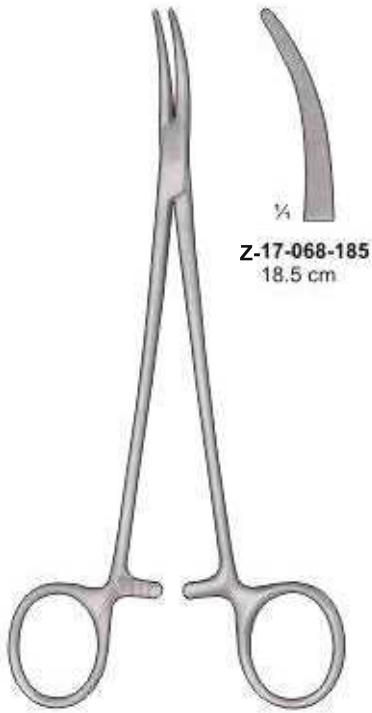

$\frac{1}{4}$   
**Z-17-068-185**  
18.5 cm

**NISSEN**



$\frac{1}{4}$   $\frac{1}{4}$   
**Z-17-069-195** **Z-17-070-195**  
19.5 cm 19.5 cm

**YASARGIL**

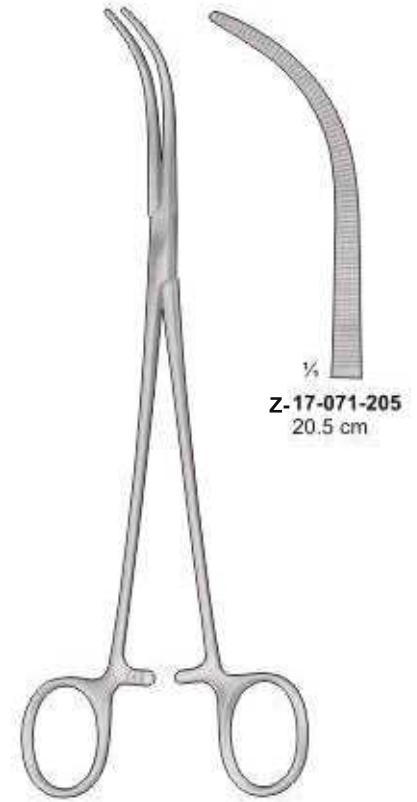

$\frac{1}{4}$   
**Z-17-071-205**  
20.5 cm

**OVERHOLT-MIXTER**



$\frac{1}{4}$   
**17-072-130** **17-073-140** **17-074-130** **17-075-140**  
13.0 cm 14.0 cm 13.0 cm 14.0 cm

$\frac{1}{4}$   
**17-076-130** **17-077-150** **17-078-175** **17-079-200** **17-080-130** **17-081-150** **17-082-175** **17-083-200**  
13.0 cm 15.0 cm 17.5 cm 20 cm 13.0 cm 15.0 cm 17.5 cm 20 cm

**PEAN**  
Slender Type

**SPENCER-WELLS**  
Slender Type

Arterienklemmen  
 Pinzas hemostaticas

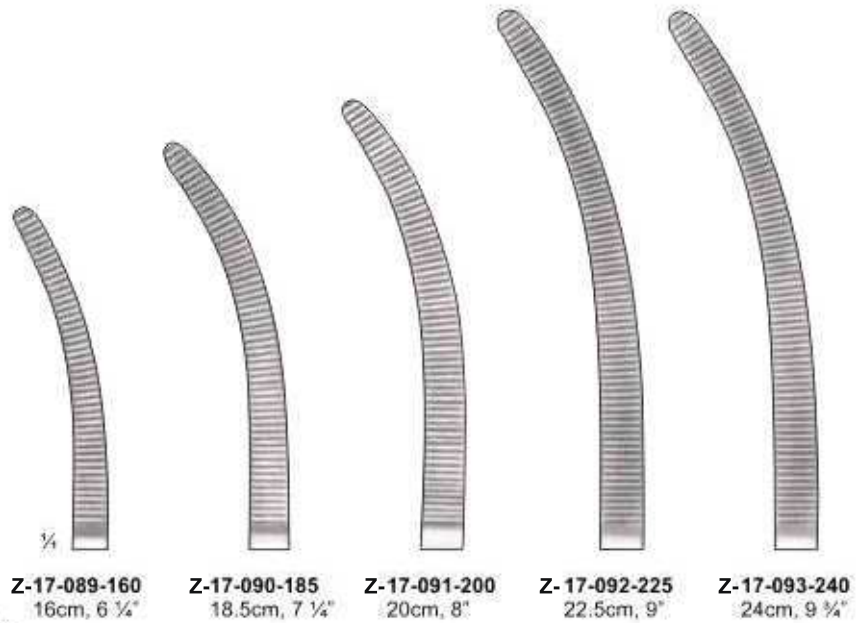
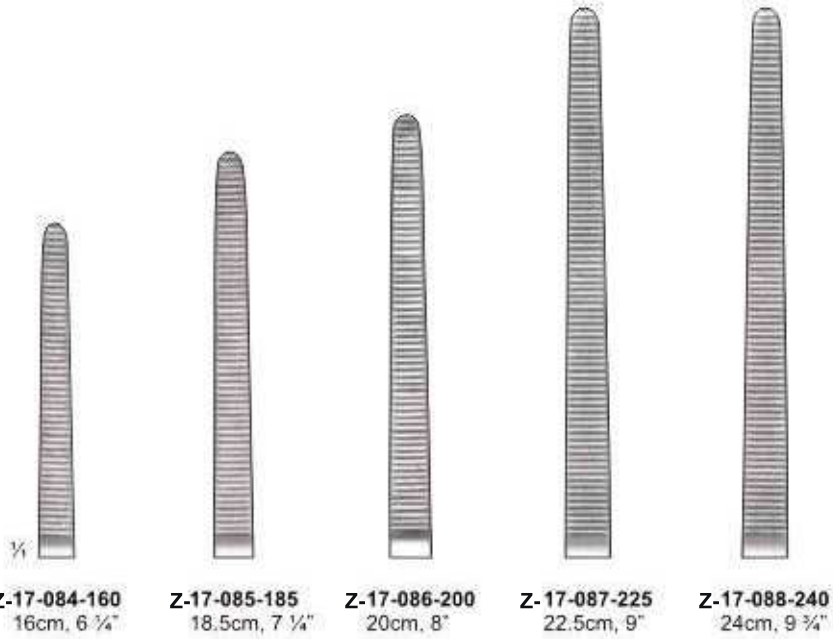

**ROCHESTER-PEAN**





**KOCHER-OCHSNER**

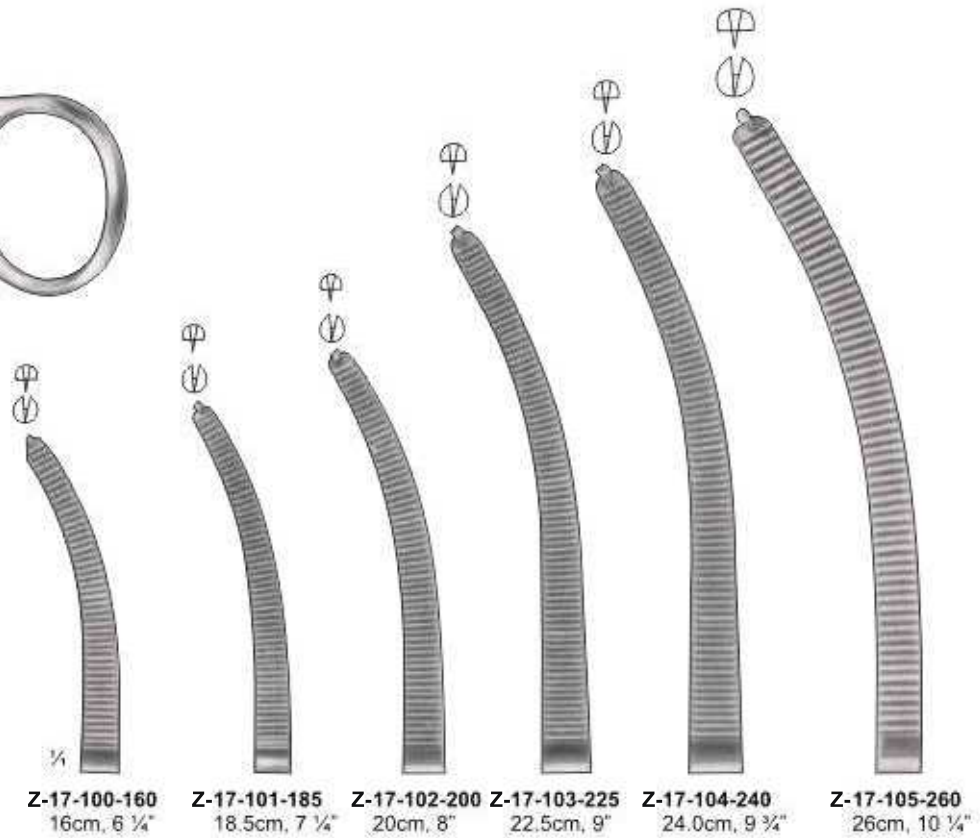
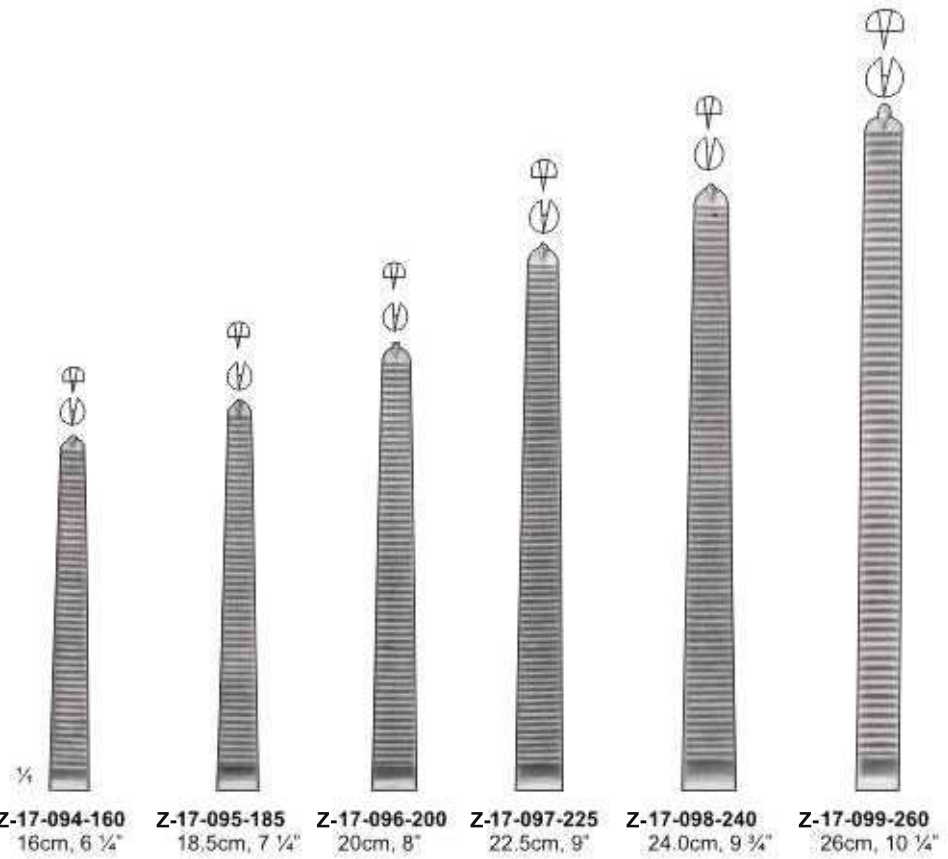

Arterienklemmen  
 Pinzas hemostaticas



**PEAN**

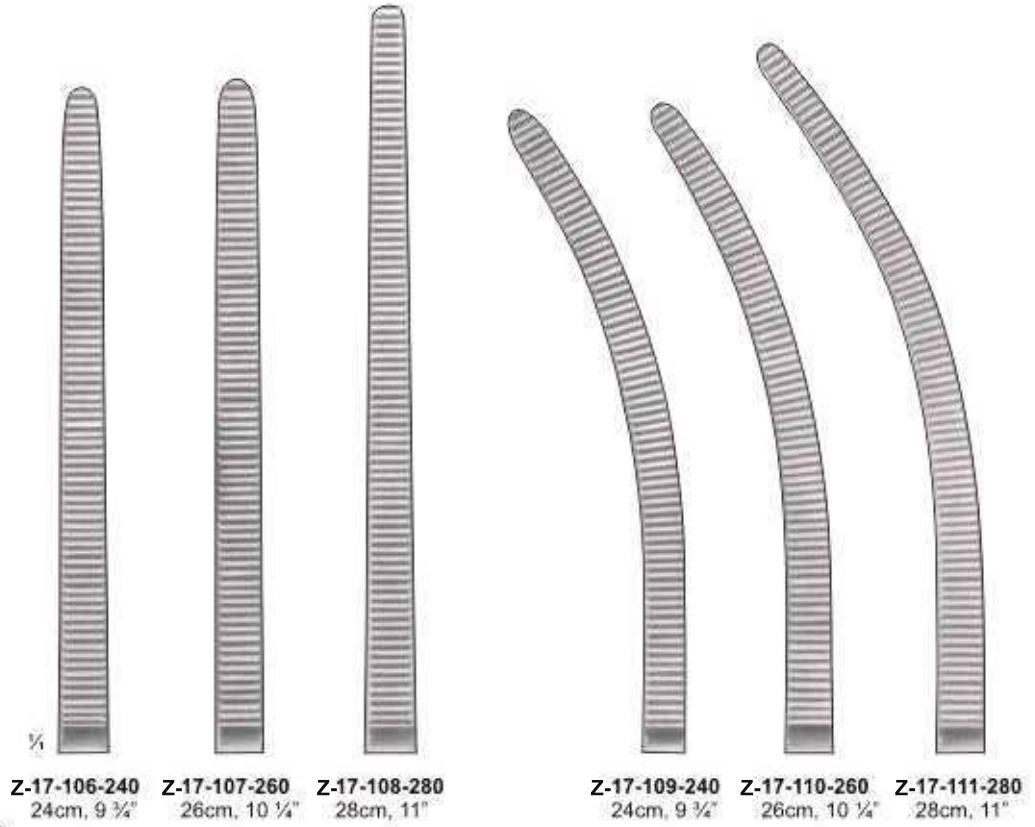

**Z-17-106-240** 24cm, 9 3/4"  
**Z-17-107-260** 26cm, 10 1/4"  
**Z-17-108-280** 28cm, 11"

**Z-17-109-240** 24cm, 9 3/4"  
**Z-17-110-260** 26cm, 10 1/4"  
**Z-17-111-280** 28cm, 11"

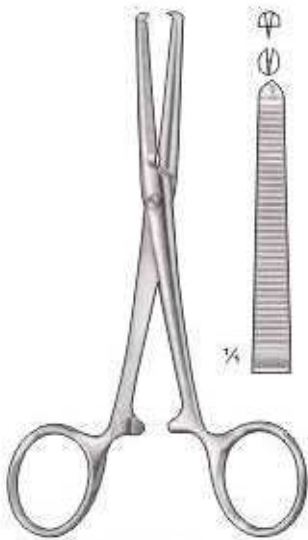

**KOCHER**  
 Strong Pattern  
**Z-17-112-145**  
 14.5cm, 5 3/4"

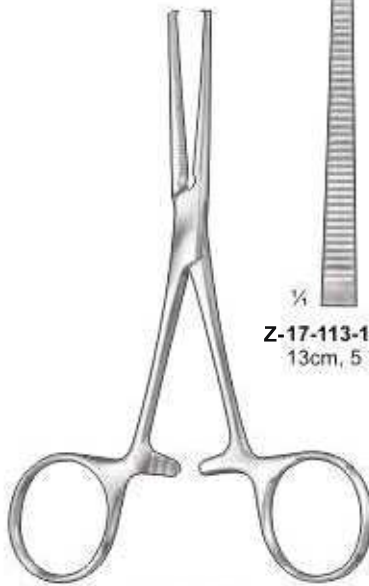

**KOCHER**

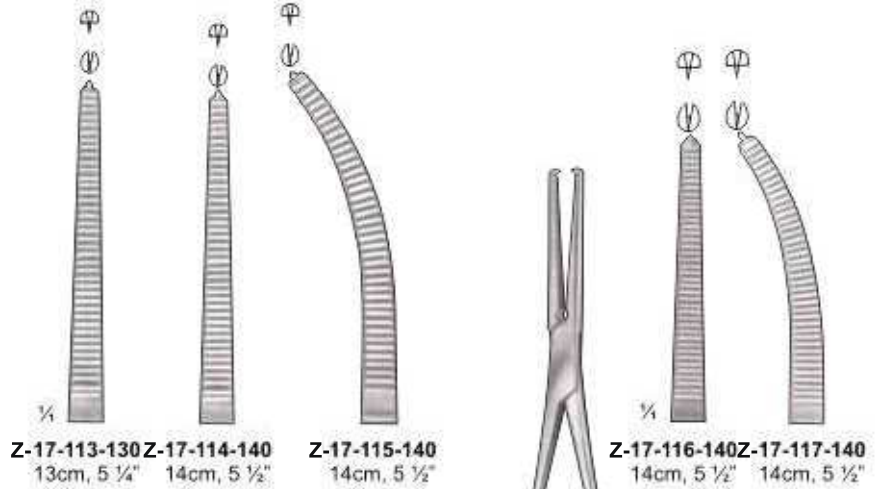

**Z-17-113-130** 13cm, 5 1/4"  
**Z-17-114-140** 14cm, 5 1/2"

**Z-17-115-140**  
 14cm, 5 1/2"

**Z-17-116-140** 14cm, 5 1/2"  
**Z-17-117-140** 14cm, 5 1/2"

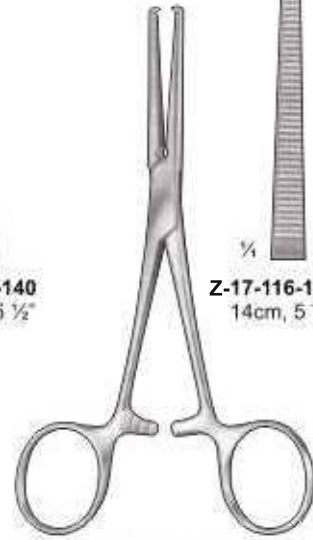

**ROCHESTER-OCHSNER**

# HAEMOSTATIC FORCEPS

Arterienklemmen  
Pinzas hemostaticas

Pinces hemostatiques  
Pinze emostatiche



Z-17-118-160 16cm, 6 1/4"  
Z-17-119-200 20cm, 8"  
Z-17-120-160 16cm, 6 1/4"  
Z-17-121-200 20cm, 8"

**ROCHESTER-CARMALT**

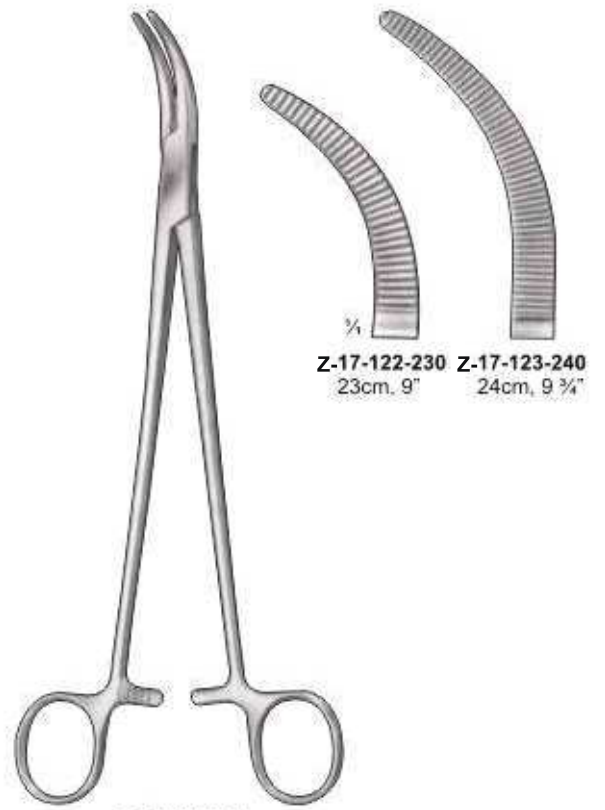

Z-17-122-230 23cm, 9"  
Z-17-123-240 24cm, 9 1/4"

**MOYNIHAN**

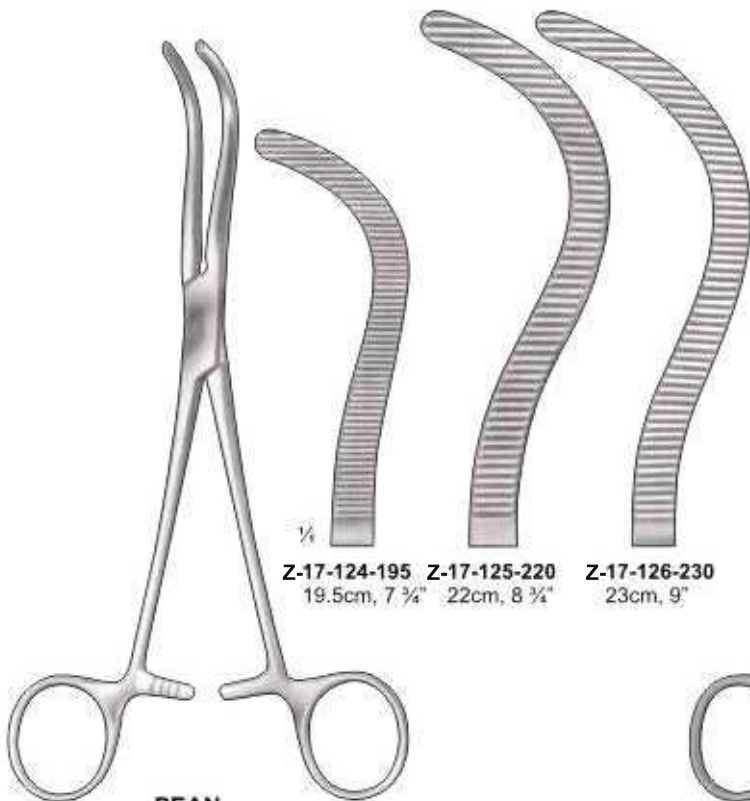

Z-17-124-195 19.5cm, 7 3/4"  
Z-17-125-220 22cm, 8 1/4"  
Z-17-126-230 23cm, 9"

**PEAN**

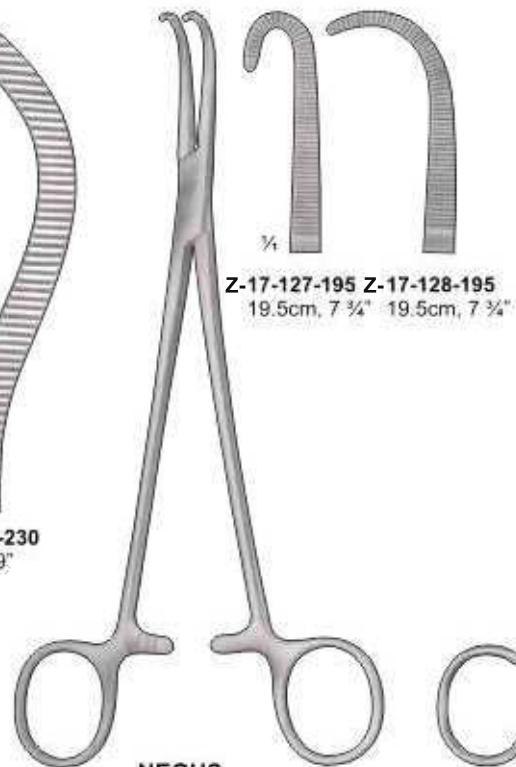

Z-17-127-195 19.5cm, 7 3/4"  
Z-17-128-195 19.5cm, 7 3/4"

**NEGUS**

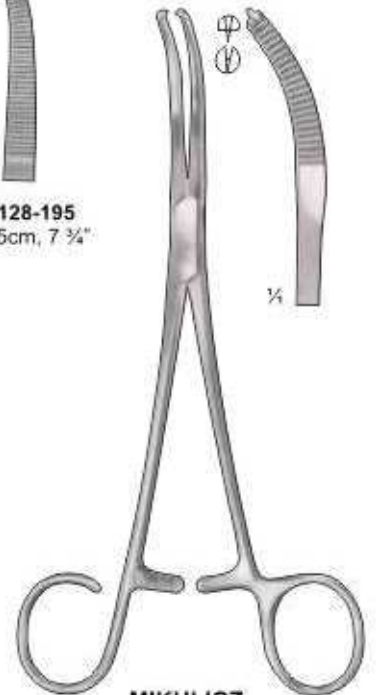

**MIKULICZ**  
Z-17-129-185  
18.5cm, 7 1/4"

Arterienklemmen  
 Pinzas hemostaticas

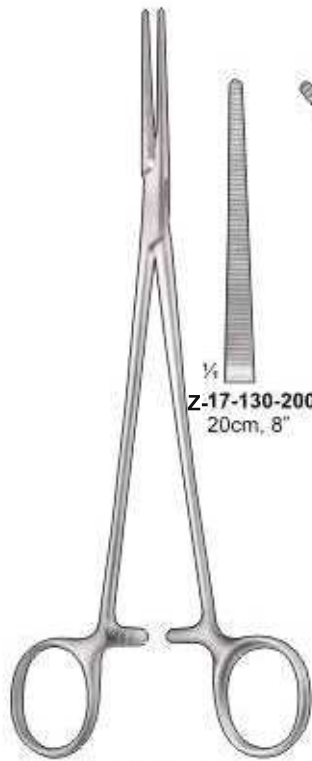

Z-17-130-200 17-131-200 17-132-200 17-133-200  
 20cm, 8" 20cm, 8" 20cm, 8" 20cm, 8"

**HALSTED-MOSQUITO**

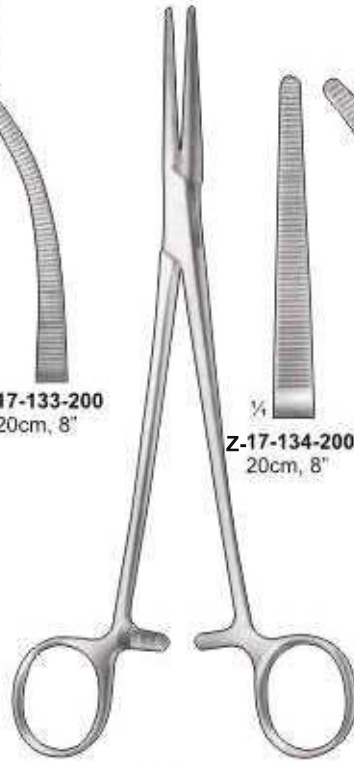

Z-17-134-200 17-135-200 17-136-200 17-137-200 17-138-200  
 20cm, 8" 20cm, 8" 20cm, 8" 20cm, 8" 20cm, 8"

**HEISS**



Z-17-139-215 17-140-215  
 21.5cm, 8 1/2" 21.5cm, 8 1/2"

**HALSTED**

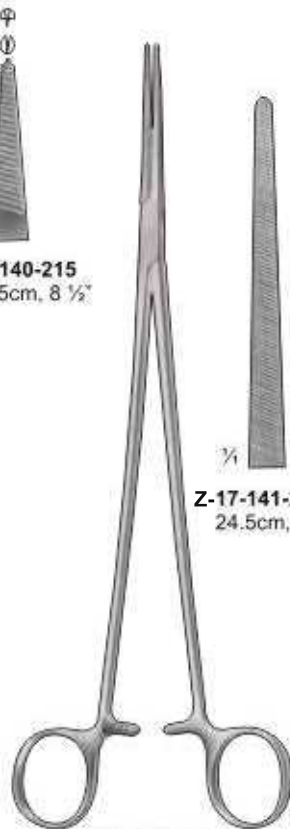

Z-17-141-245 Z-17-142-245 Z-17-143-245 Z-17-144-245  
 24.5cm, 9 1/2" 24.5cm, 9 1/2" 24.5cm, 9 1/2" 24.5cm, 9 1/2"

**BENGOLEA**



Z-17-145-245  
 24.5cm, 9 1/2"

**CRAFOORD**

# HAEMOSTATIC FORCEPS

Arterienklemmen  
Pinzas hemostaticas

Pinces hemostatiques  
Pinze emostatiche

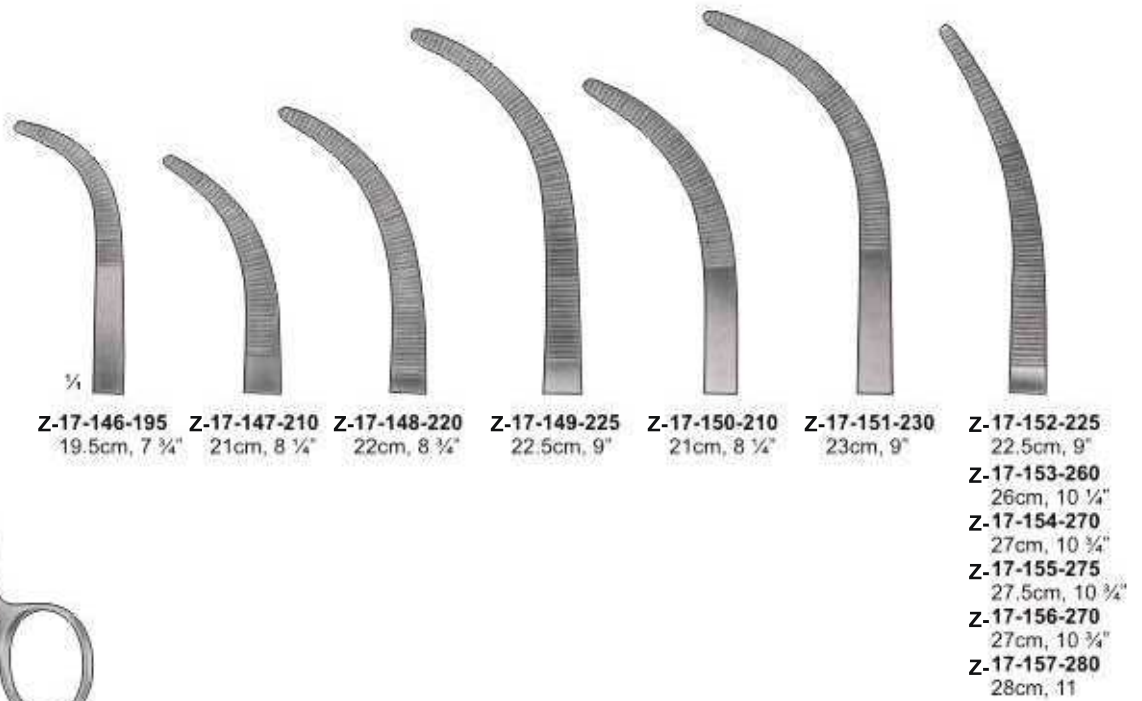

- |                                       |                                     |                                     |                                   |                                     |                                 |                                   |                                      |                                      |  |                                      |                                  |
|---------------------------------------|-------------------------------------|-------------------------------------|-----------------------------------|-------------------------------------|---------------------------------|-----------------------------------|--------------------------------------|--------------------------------------|--|--------------------------------------|----------------------------------|
| <b>Z-17-146-195</b><br>19.5cm, 7 3/4" | <b>Z-17-147-210</b><br>21cm, 8 1/4" | <b>Z-17-148-220</b><br>22cm, 8 1/2" | <b>Z-17-149-225</b><br>22.5cm, 9" | <b>Z-17-150-210</b><br>21cm, 8 1/4" | <b>Z-17-151-230</b><br>23cm, 9" | <b>Z-17-152-225</b><br>22.5cm, 9" | <b>Z-17-153-260</b><br>26cm, 10 1/4" | <b>Z-17-154-270</b><br>27cm, 10 3/4" | <b>Z-17-155-275</b><br>27.5cm, 10 3/4" | <b>Z-17-156-270</b><br>27cm, 10 3/4" | <b>Z-17-157-280</b><br>28cm, 11" |
|---------------------------------------|-------------------------------------|-------------------------------------|-----------------------------------|-------------------------------------|---------------------------------|-----------------------------------|--------------------------------------|--------------------------------------|--|--------------------------------------|----------------------------------|

**OVERHOLT-GEISSENDOERFER**

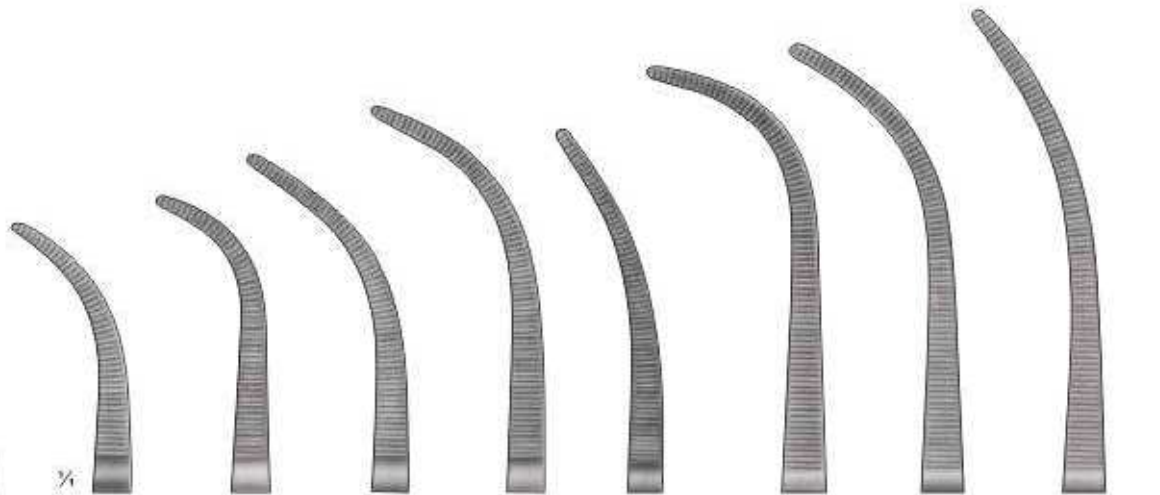

- |                                     |                                       |                                     |                                   |                                   |  |  |                                  |
|-------------------------------------|---------------------------------------|-------------------------------------|-----------------------------------|-----------------------------------|--|--|----------------------------------|
| <b>Z-17-158-210</b><br>21cm, 8 1/4" | <b>Z-17-159-215</b><br>21.5cm, 8 1/2" | <b>Z-17-160-220</b><br>22cm, 8 3/4" | <b>Z-17-161-225</b><br>22.5cm, 9" | <b>Z-17-162-225</b><br>22.5cm, 9" | <b>Z-17-163-295</b><br>29.5cm, 11 3/4" | <b>Z-17-164-295</b><br>29.5cm, 11 3/4" | <b>Z-17-165-300</b><br>30cm, 12" |
|-------------------------------------|---------------------------------------|-------------------------------------|-----------------------------------|-----------------------------------|--|--|----------------------------------|

**OVERHOLT**  
Fine Pattern

Arterienklemmen  
 Pinzas hemostaticas



**MIXTER-O'SHAUGNESSY**  
 Z-17-166-190  
 19cm, 7 1/2"



**HEISS**  
 Z-17-167-195  
 19.5cm, 7 3/4"



**FINOCHIETTO**  
 Z-17-168-245  
 24.5cm, 9 1/2"



**RUMEL**



**Z-17-169-245**  
 24cm, 9 1/2"

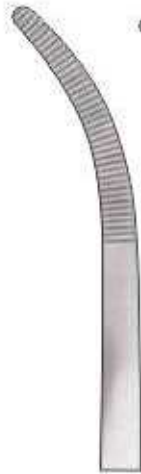

**Z-17-170-245**  
 24cm, 9 1/2"



**Z-17-171-245**  
 24cm, 9 1/2"



**Z-17-172-245**  
 24cm, 9 1/2"

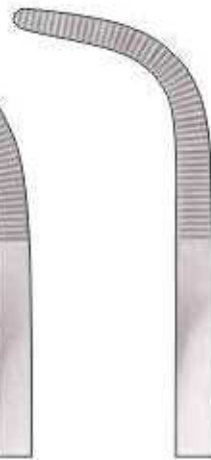

**Z-17-173-245**  
 24cm, 9 1/2"

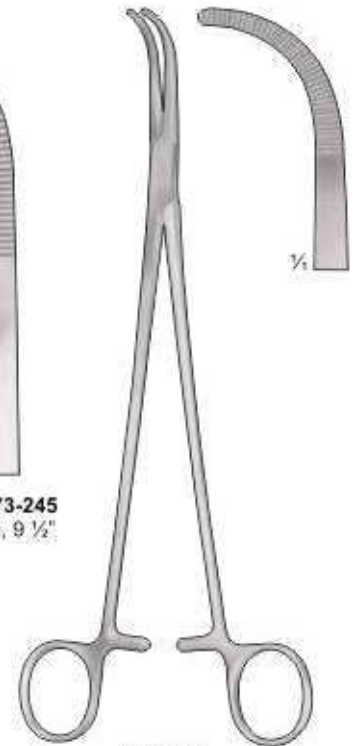

**MIXTER**  
 Z-17-174-230  
 23cm, 9"



**MINI-GEMINI**  
curved, serrated



**Z-17-175-180**  
18 cm, 7"

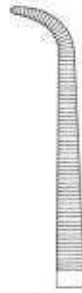

**Z-17-176-220**  
22 cm, 8 3/4"



**Z-17-177-250**  
25 cm, 10"



**Z-17-178-280**  
28 cm, 11"



**GEMINI**  
Curved, Serrated



**Z-17-179-130**  
13 cm, 5"



**Z-17-180-160**  
16 cm, 6 1/4"

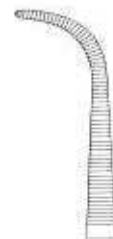

**Z-17-181-180**  
18 cm, 7"



**Z-17-182-200**  
20 cm, 8"



**Z-17-183-230**  
23 cm, 9"



**Z-17-184-250**  
25 cm, 10"



**Z-17-185-280**  
28 cm, 11"

Arterienklemmen  
 Pinzas hemostaticas



**LAWRENCE**  
 Z-17-186-270  
 27cm, 10 3/4"

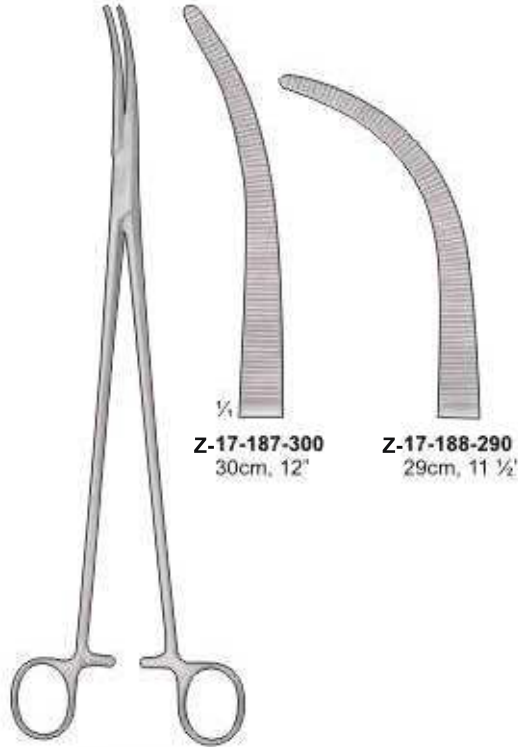

**Z-17-187-300** 30cm, 12"  
**Z-17-188-290** 29cm, 11 1/2"

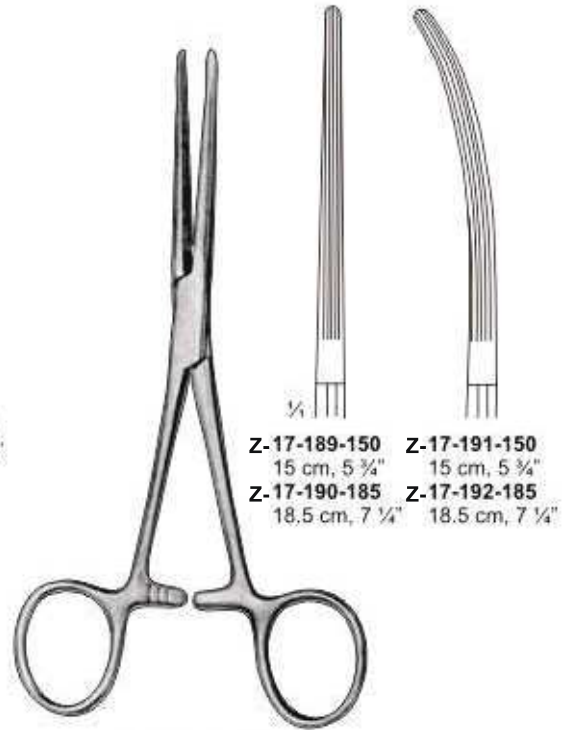

**BAINBRIDGE**

**Z-17-189-150** 15 cm, 5 3/4"  
**Z-17-190-185** 18.5 cm, 7 1/4"  
**Z-17-191-150** 15 cm, 5 3/4"  
**Z-17-192-185** 18.5 cm, 7 1/4"



**BRIDGE**  
 Z-17-193-280  
 28 cm, 11"  
 Curved, Serrated



**LAWRENCE**  
 Z-17-194-280  
 28.0 cm, 11"



**KANTROWITZ**  
**Z-17-195-200** 20 cm, 8"  
**Z-17-196-240** 24 cm, 9 1/2"  
**Z-17-197-280** 28 cm, 11"  
 Right Angle, Serrated



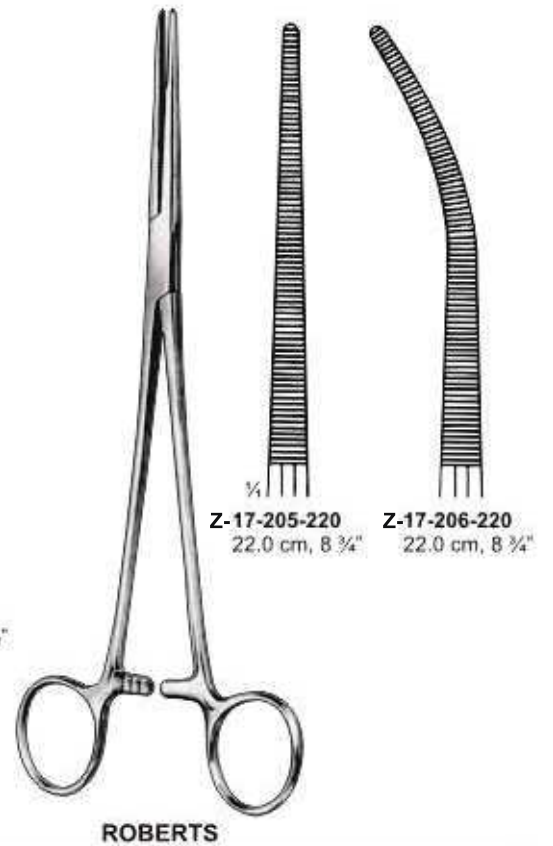
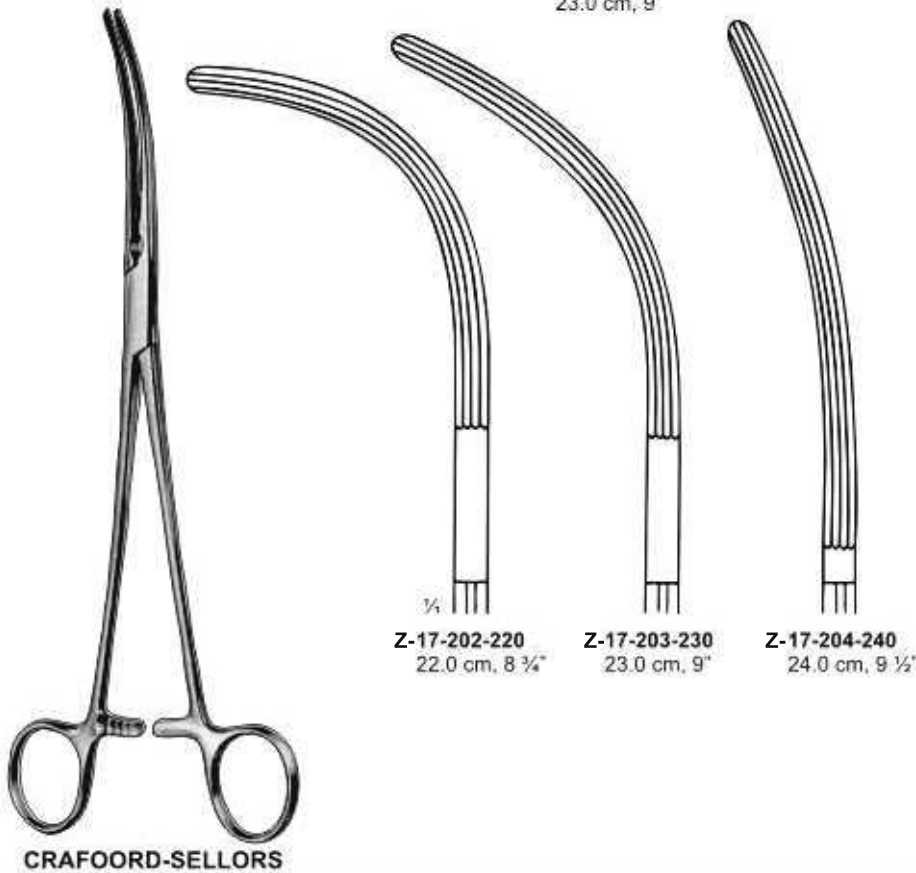
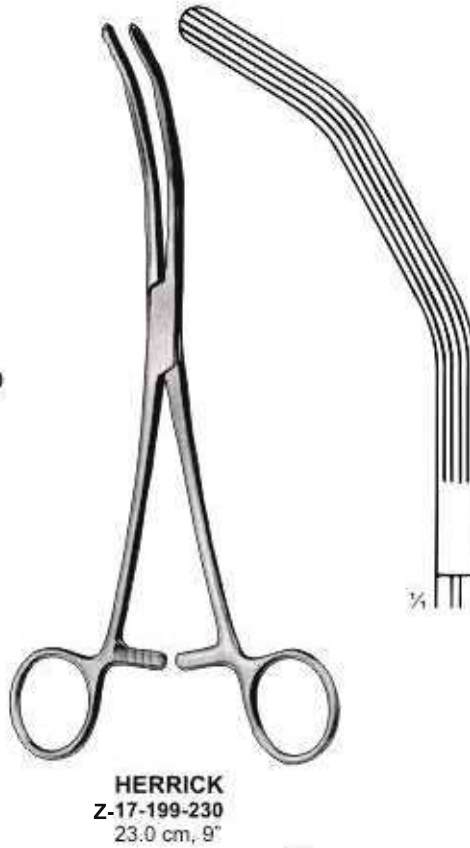

Arterienklemmen  
 Pinzas hemostaticas



**WIKSTROEM**  
 Z-17-207-190  
 19.0 cm, 7 1/2"

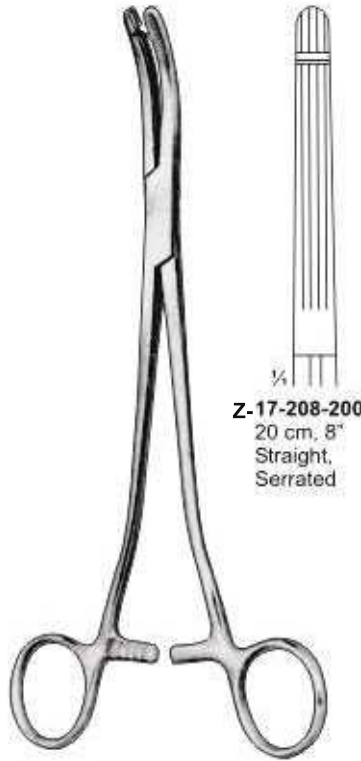

**HEANEY / BALLANTINE**

Z-17-208-200  
 20 cm, 8"  
 Straight,  
 Serrated



**HEANEY / REZAK**  
 Z-17-210-210 21 cm, 8 1/4"  
 Straight, Cross Serrated

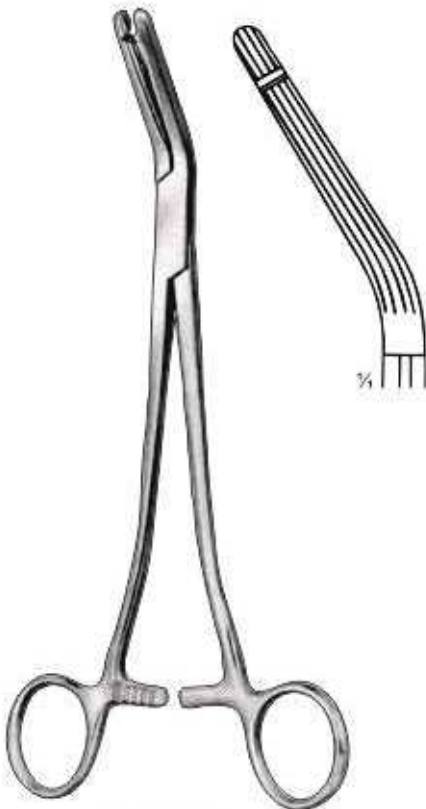

**GARLAND**  
 Z-17-211-210  
 21 cm, 8 1/4"



**DIXON-LOVELACE 1:2**  
 Z-17-212-155 15.5 cm, 6"

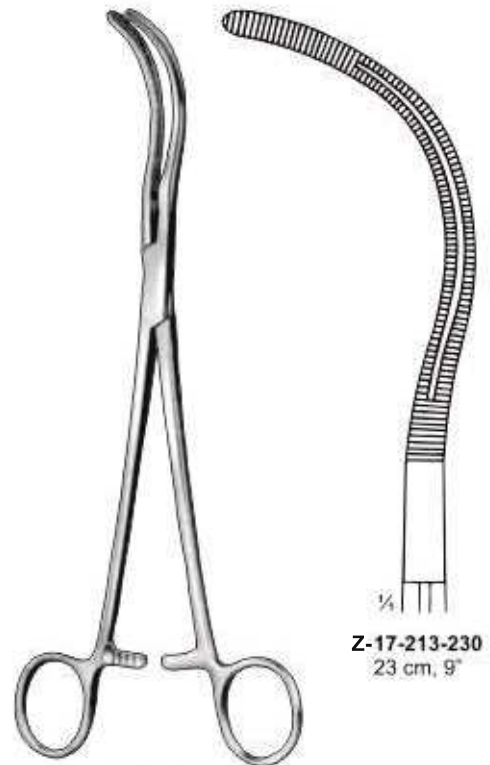

**STILLE**

Z-17-213-230  
 23 cm, 9"

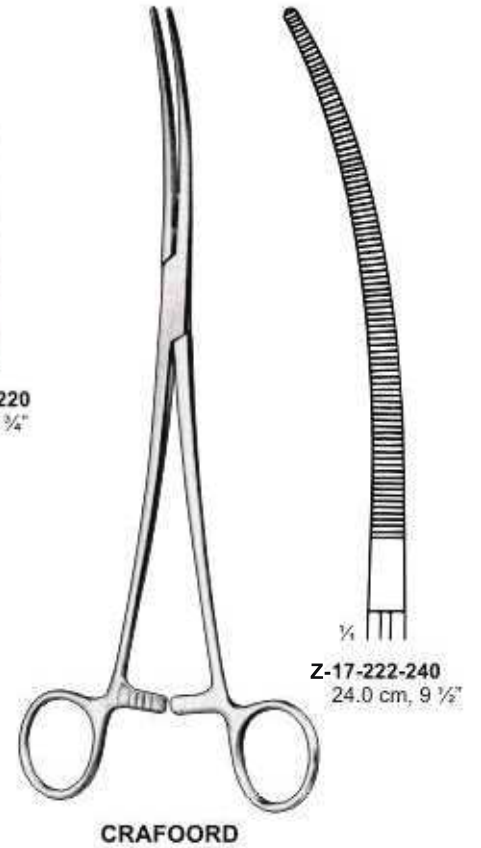
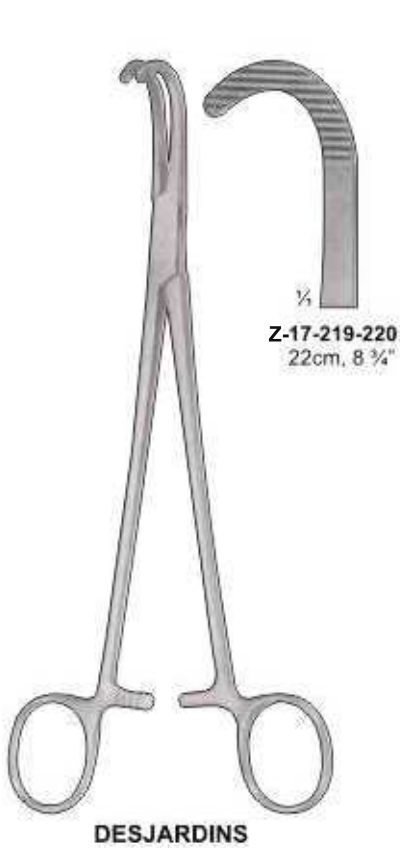
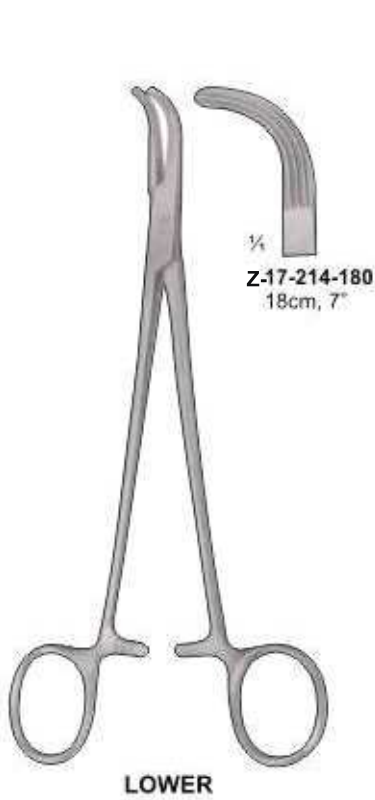

Arterienklemmen  
Pinzas hemostaticas

Pinces hemostatiques  
Pinze emostatiche



GUYON



Z-17-223-200  
20 cm, 8"

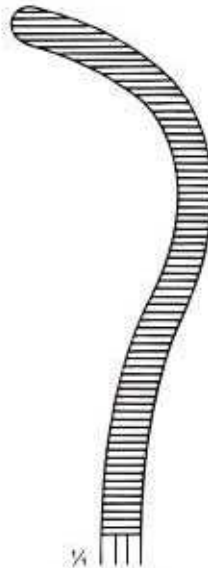

Z-17-224-220  
22 cm, 8 1/2"

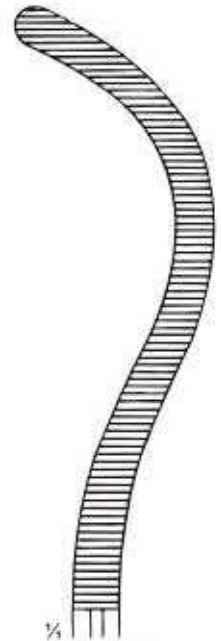

Z-17-225-240  
24 cm, 9 1/2"



GUYON



Z-17-226-230  
23 cm, 9"



Z-17-227-240  
24 cm, 9 1/2"



GUYON

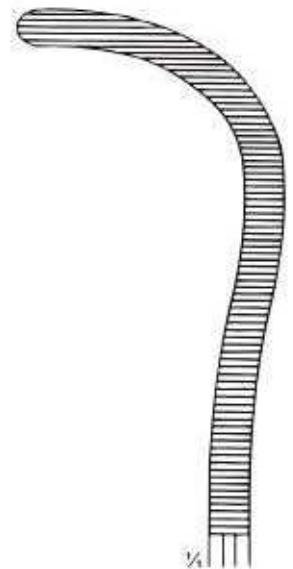

Z-17-228-230  
23 cm, 9"

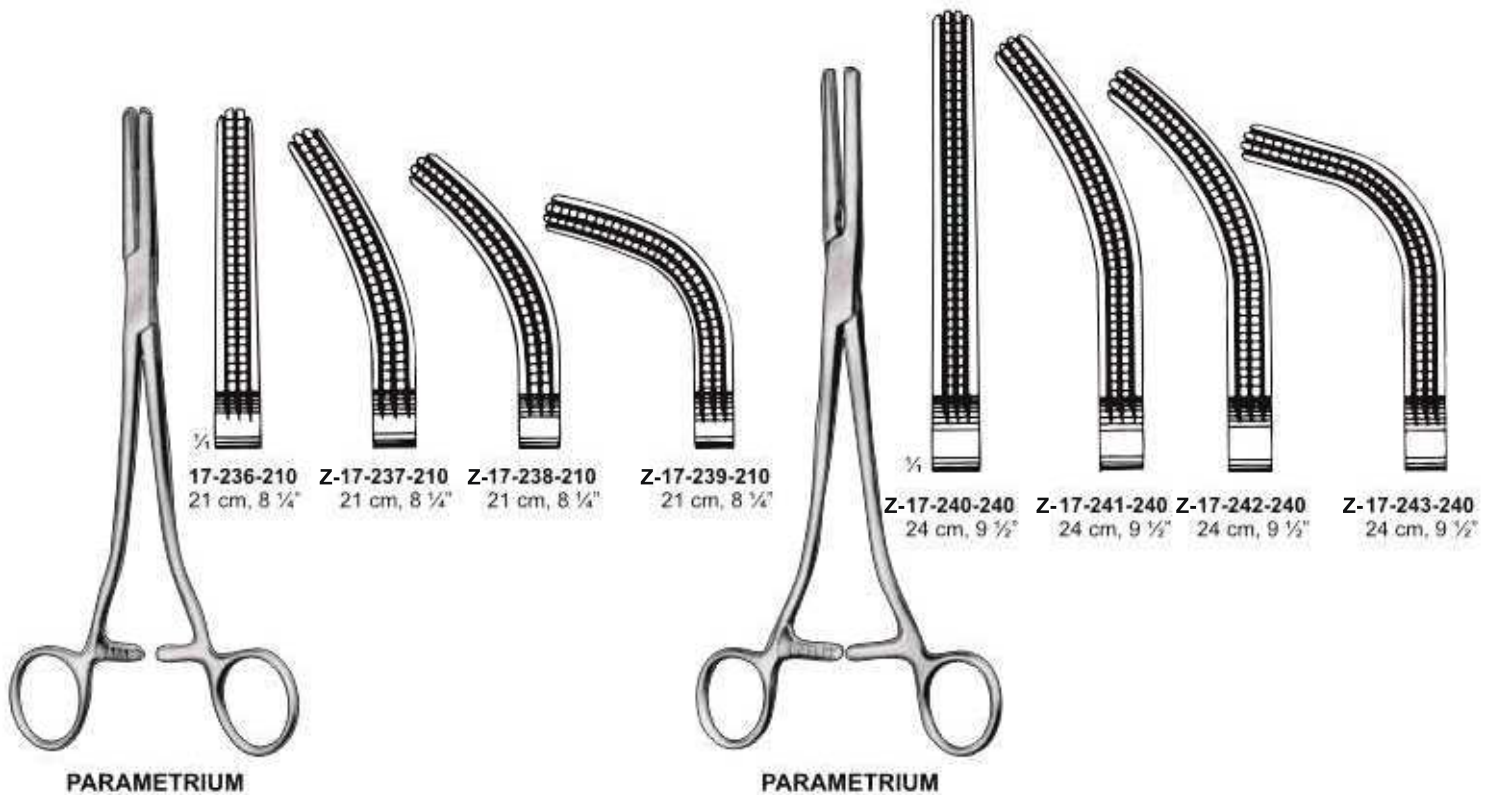
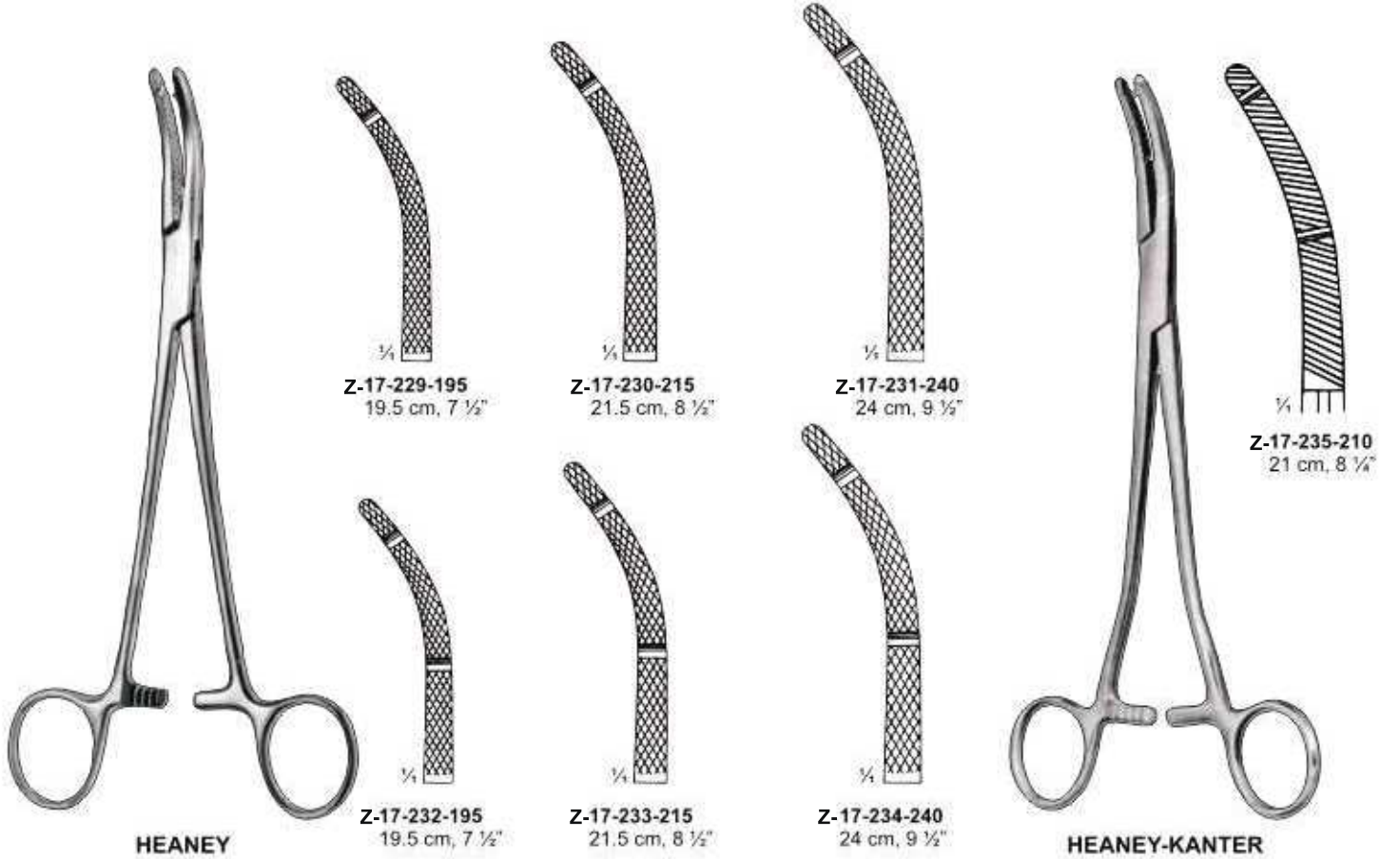

Arterienklemmen  
 Pinzas hemostaticas



HEISS

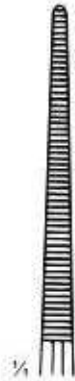

Fig.1  
 Z-17-244-200  
 20.0 cm, 8"



Fig.2  
 Z-17-245-200  
 20.0 cm, 8"



Fig.3  
 Z-17-246-200  
 20.0 cm, 8"



JOHN HOPKINS



Z-17-247-200  
 20.0 cm, 8"



SEGOND-LANDAU



Z-17-248-240  
 24 cm, 9 1/2"



Z-17-249-240  
 24 cm, 9 1/2"

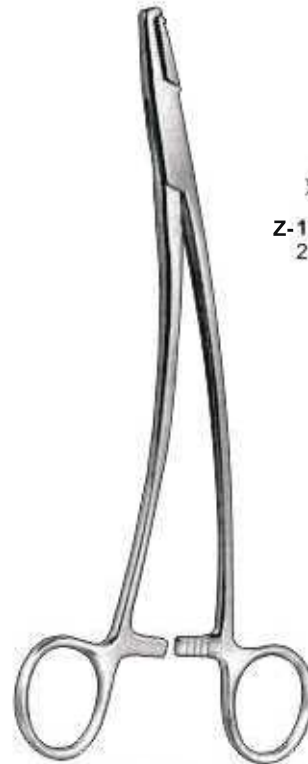

SCHINDLER 1:2

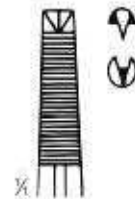

Z-17-250-200  
 20 cm, 8"

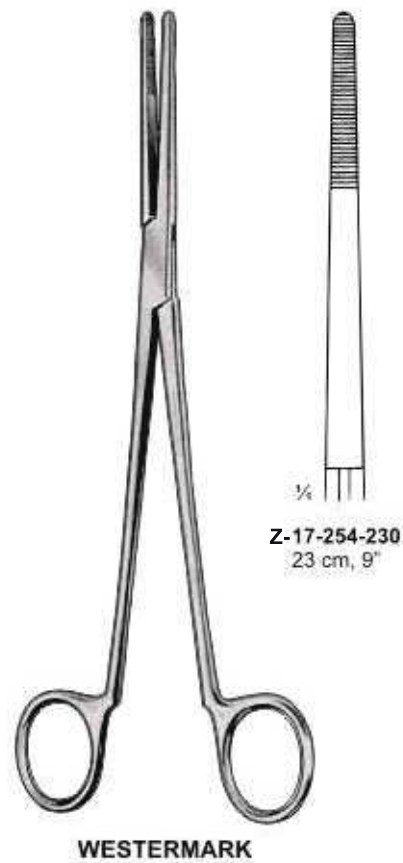
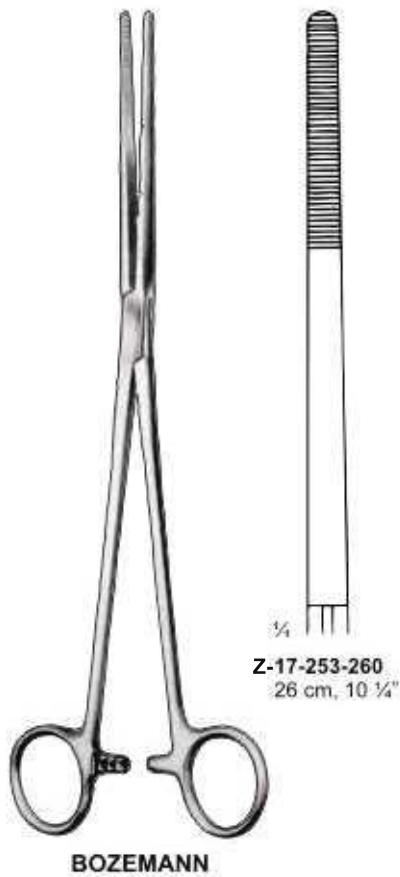
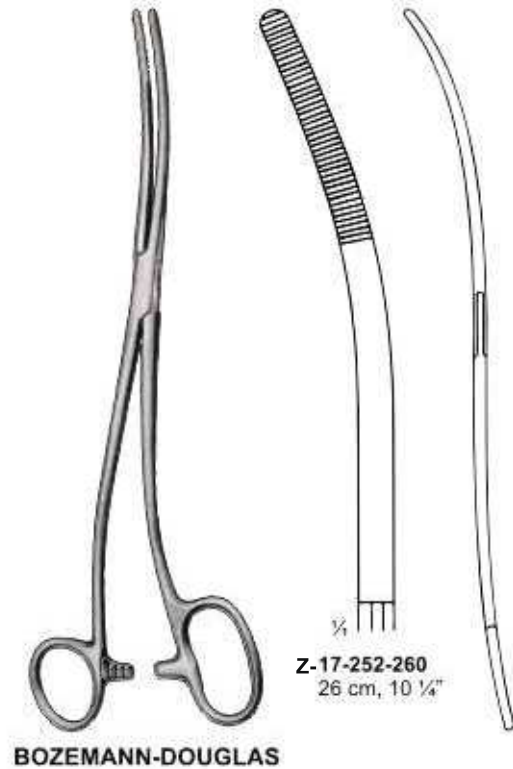
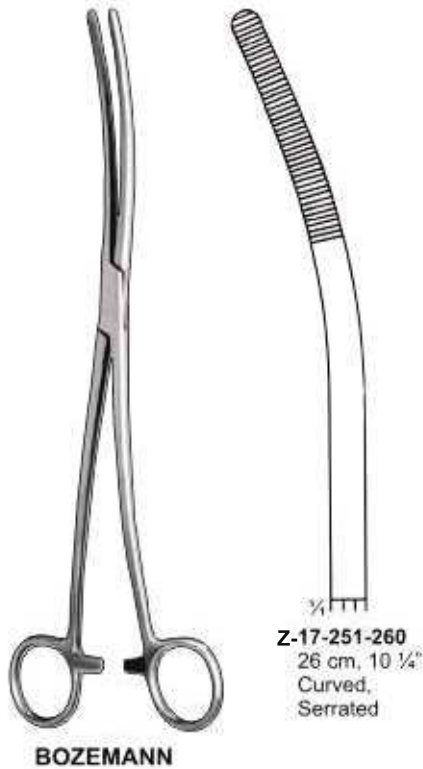

Arterienklemmen  
 Pinzas hemostaticas

Pinces hemostatiques  
 Pinze emostatiche



GRAY



Z-17-255-220  
 22 cm, 8 1/2"

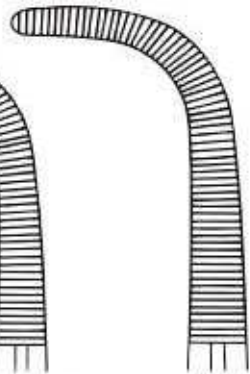

Z-17-256-230  
 23 cm, 9"



GRAY 1:2

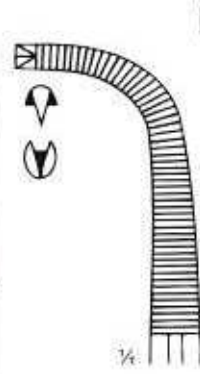

Z-17-257-220  
 22 cm, 8 1/2"

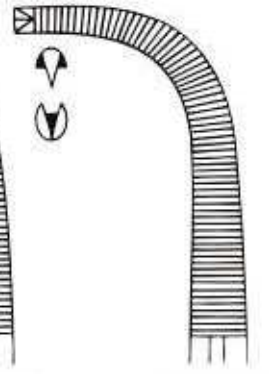

Z-17-258-230  
 23 cm, 9"



PHANEUF 1:2



Z-17-259-215  
 21.5 cm, 8 1/2"



Z-17-260-215  
 21.5 cm, 8 1/2"



LONG  
 Z-17-261-190  
 19.0 cm, 7 1/2"







**BABY-MIKULICZ**  
Z-17-262-140  
14cm, 5 1/2"

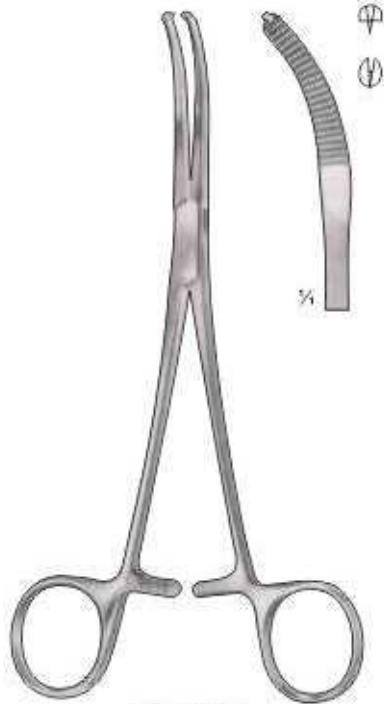

**MIKULICZ**  
Z-17-263-185  
18.5cm, 7 1/4"

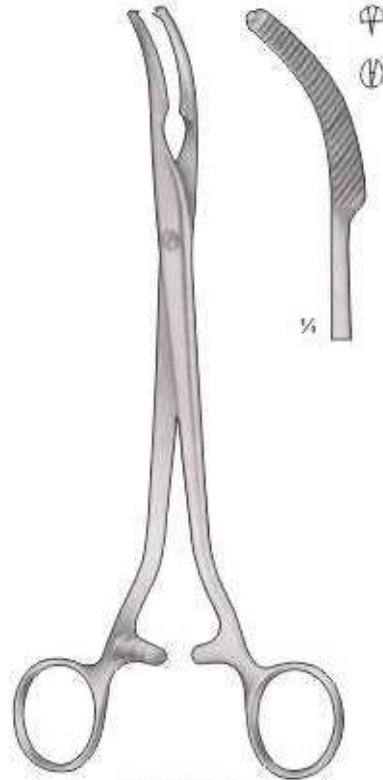

**MIKULICZ**  
Z-17-264-205  
20.5cm, 8"

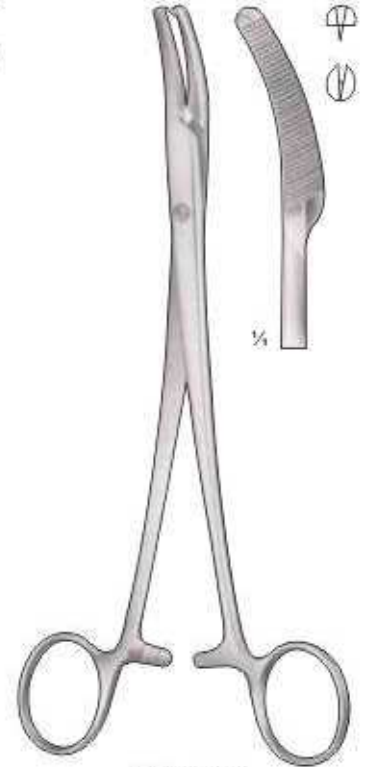

**MIKULICZ**  
Z-17-265-200  
20cm, 8"



**MIKULICZ**  
Z-17-266-205  
20.5cm, 8"

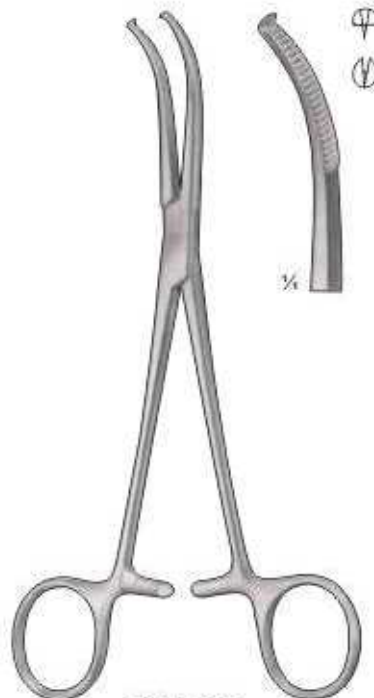

**MIKULICZ**  
Z-17-267-205  
20.5cm, 8"



**Z-17-268-205Z-17-269-205**  
20.5cm, 8" 20.5cm, 8"

**FAURE**

Arterienklemmen  
 Pinzas hemostaticas



**Z-17-269-210** **Z-17-270-205**  
 21cm, 8 1/4" 20.5cm, 8"

**PHANEUF**

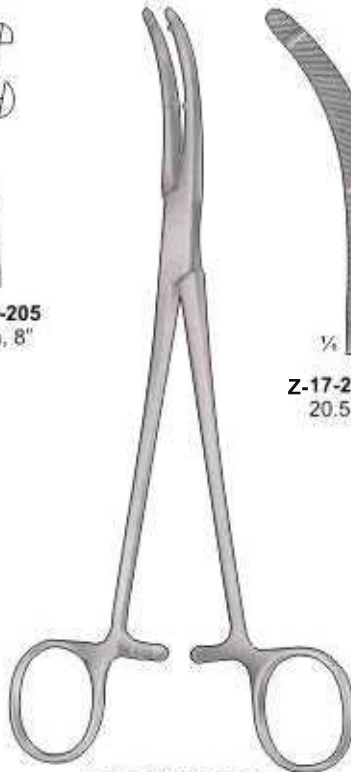

**Z-17-271-205** **Z-17-272-245**  
 20.5cm, 8" 24.5cm, 9 3/4"

**HEANEY MODIF.**

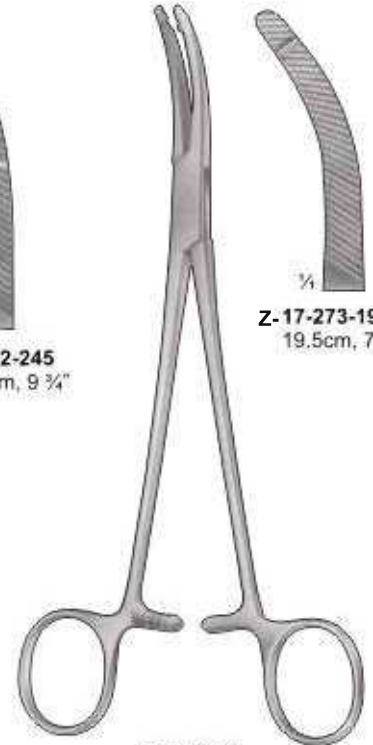

**Z-17-273-195**  
 19.5cm, 7 3/4"

**HEANEY**

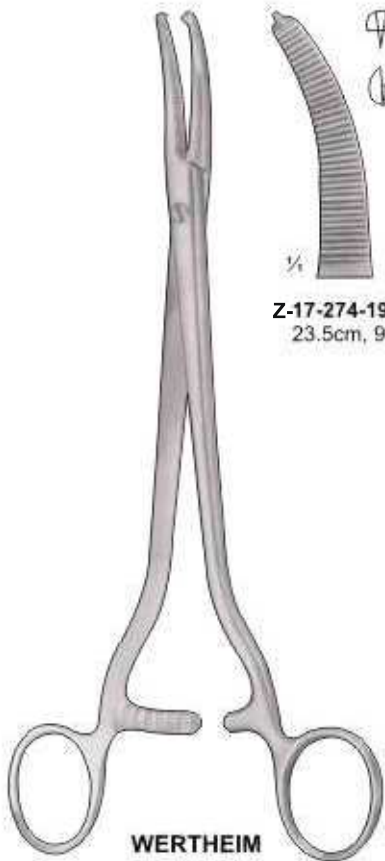

**Z-17-274-195**  
 23.5cm, 9 1/4"

**WERTHEIM**

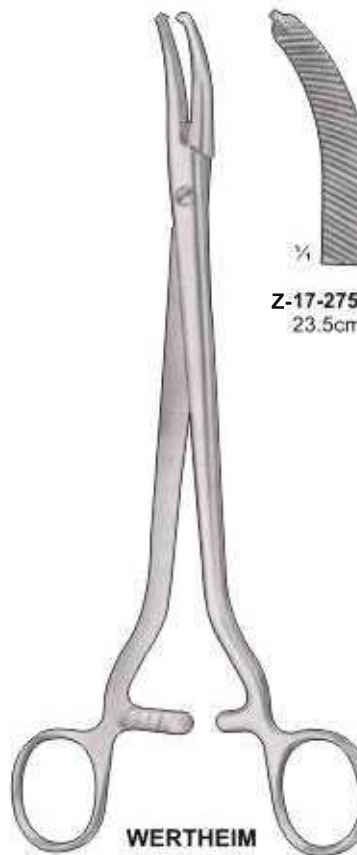

**Z-17-275-235**  
 23.5cm, 9 1/4"

**WERTHEIM**



**Z-17-276-245**  
 24.5cm, 9 3/4"

**WERTHEIM**

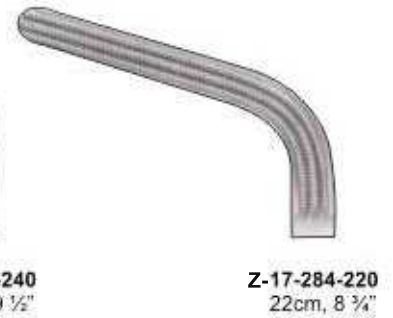
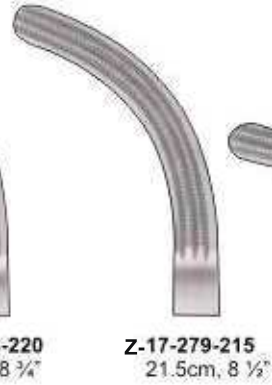

Arterienklemmen  
 Pinzas hemostaticas

Pinces hemostatiques  
 Pinze emostatiche



**WERTHEIM**  
 Hysterectomy Forceps  
 Z-17-285-255  
 25.5cm, 10"

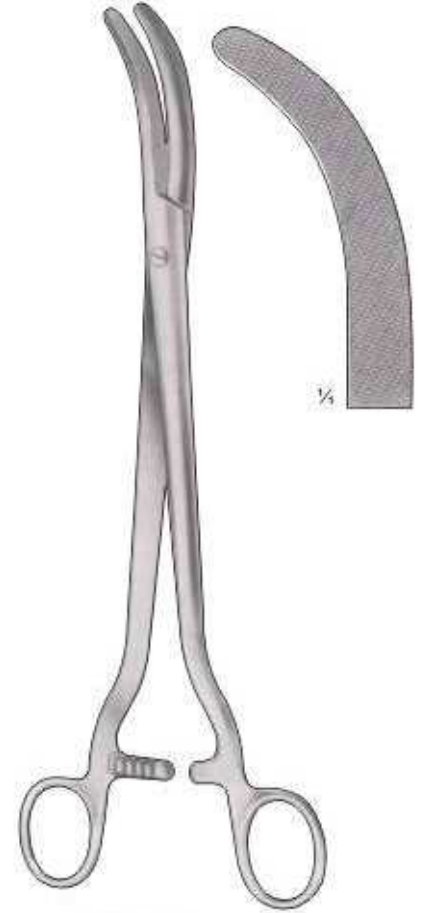

**WERTHEIM**  
 Parametrium Clamp  
 Z-17-286-260  
 26cm, 10 1/4"



**DICK**



Z-17-287-255 25.5cm, 10"    Z-17-288-265 26.5cm, 10 1/2"    Z-17-289-275 27.5cm, 10 3/4"



**WERTHEIM-CULLEN**  
Z-17-290-215  
21.5cm, 8 1/2"



**WERTHEIM-CULLEN**  
23cm, 9"

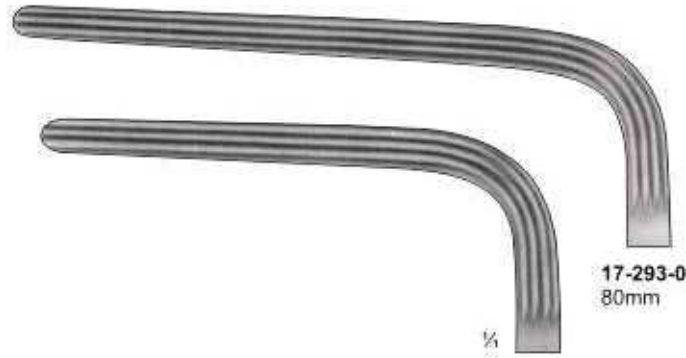

**Z-17-292-001**  
60mm

**17-293-002**  
80mm



**WERTHEIM**  
Z-17-294-250  
25cm, 10"



**JONES /  
PERFORATING**  
Z-17-295-090  
9 cm, 3 1/2"  
Slight Curve



**ENGL. MODELL**  
Z-17-296-090  
9 cm, 3 1/2"



**SCHAEDEL**  
Z-17-297-090  
9 cm, 3 1/2"



**THOMSON-WALKER'S  
PENILE CLAMPS**  
Z-17-298-090  
9 cm, 3 1/2"  
Cross-Action model.



**DOYEN**  
Z-17-299-180  
18 cm, 7"



**BACKHAUS**  
Z-17-300-080 8 cm, 3"  
Z-17-301-110 11 cm, 4 1/2"  
Z-17-302-130 13 cm, 5"  
Z-17-303-150 15 cm, 5 3/4"  
Curved

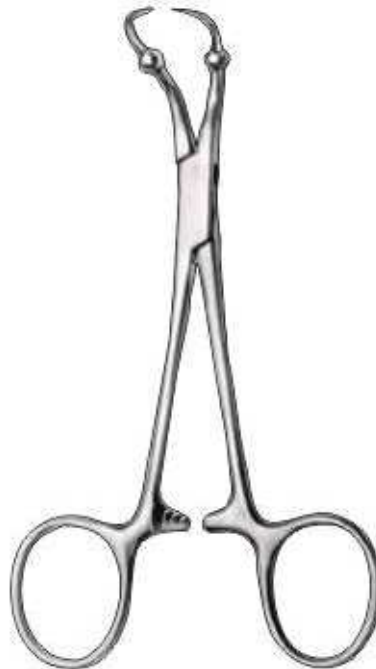

**ROEDER**  
Z-17-304-130 13 cm, 5"  
Z-17-305-150 15 cm, 6"  
Curved, Serrated



**NON-PERFORATING**  
Z-17-306-110 11 cm, 4 1/2"  
Z-17-307-130 13 cm, 5"

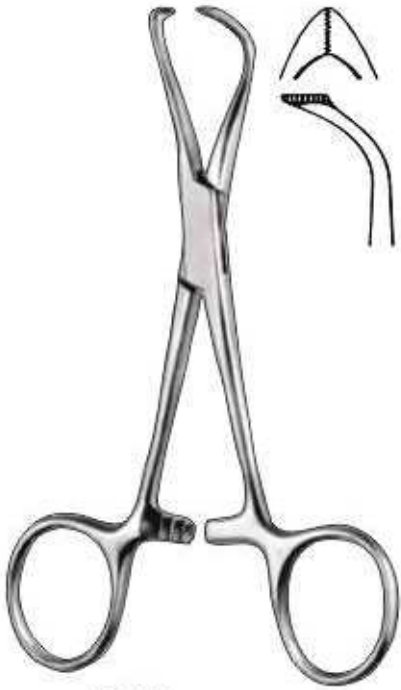

**LORNA**  
Z-17-308-100 10 cm, 4"  
Z-17-309-110 11 cm, 4 1/2"  
Z-17-310-130 13 cm, 5"



**BACKHAUS CLIP**  
Z-17-311-110 11 cm, 4 1/2"  
with clip for tubing or  
cable



**BALL & SOCKET**  
Z-17-312-130 13 cm, 5"  
Non-perforating



**TOHOKU**  
Z-17-313-100 10cm, 4"  
Z-17-314-130 13cm, 5"  
Non-Perforating

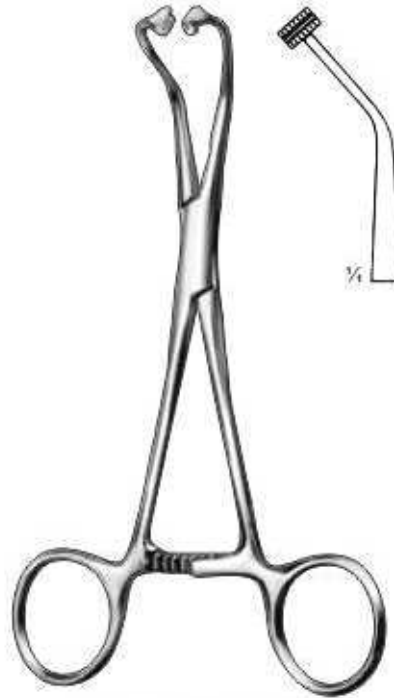

**PEERS-BERTMAN**  
Z-17-315-145  
14.5 cm, 5 3/4"  
Serrated



**BERNHARD**  
Z-17-316-165  
16.5 cm, 6 1/2"

schlauchklemmen  
Pinzas para tubos

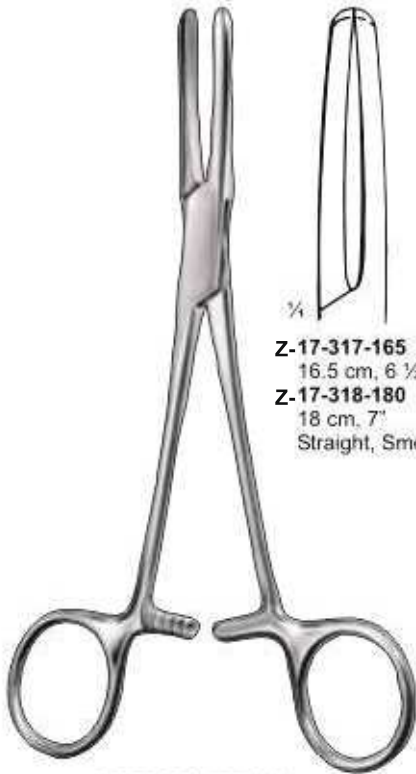

Z-17-317-165  
16.5 cm, 6 1/2"  
Z-17-318-180  
18 cm, 7"  
Straight, Smooth

**PRESBYTERIAN**



Z-17-319-180  
18 cm, 7"  
Z-17-320-200  
20 cm, 8"  
Cross Serrated

**TUBING**

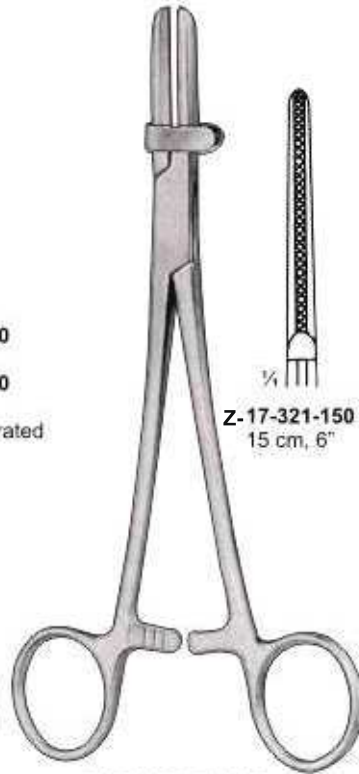

Z-17-321-150  
15 cm, 6"  
Z-17-322-180  
18 cm, 7"  
Z-17-323-200  
20 cm, 8"

**TUBING CLUMP**  
with Protector,  
Cross Serrated



Z-17-324-145  
14.5 cm, 5 3/4"  
with long ratchet

**KLINIKUM BERLIN**

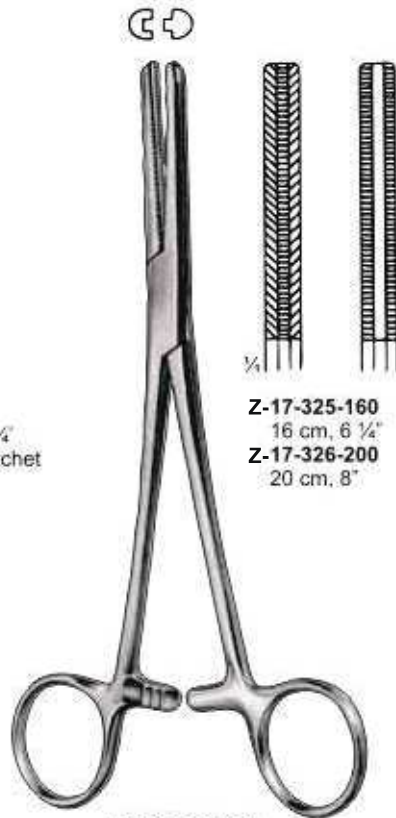

Z-17-325-160  
16 cm, 6 1/4"  
Z-17-326-200  
20 cm, 8"

**FERGUSSON**

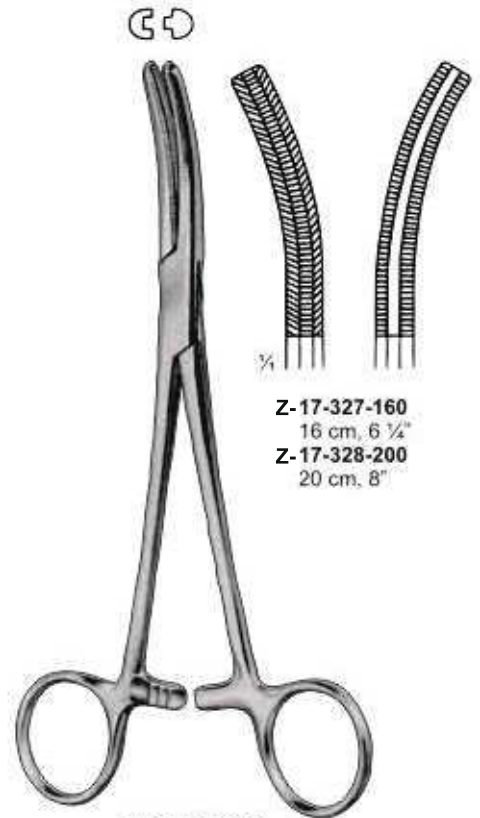

Z-17-327-160  
16 cm, 6 1/4"  
Z-17-328-200  
20 cm, 8"

**FERGUSSON**



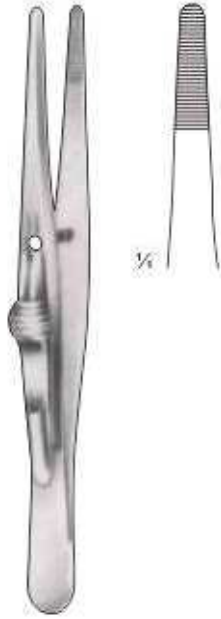

**FRICKE**  
Artery Forceps  
Z-17-329-130  
13cm, 5 1/4"

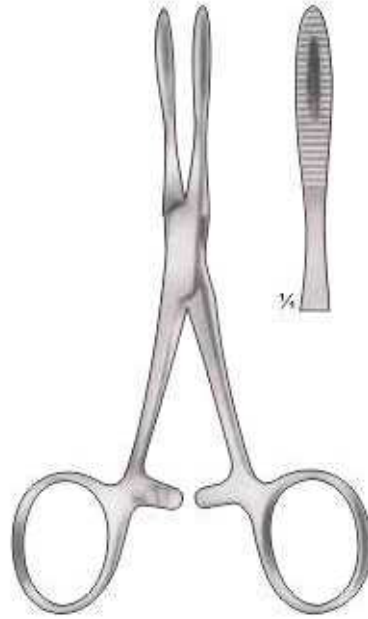

**KRONLEIN**  
Z-17-330-130  
13cm, 5 1/4"

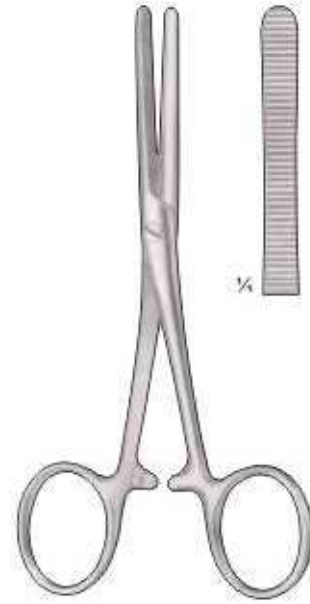

**PEAN**  
Z-17-331-125  
12.5cm, 4 3/4"



**Z-17-332-125**  
12.5cm, 4 3/4"

**PEAN**



**Z-17-333-140**  
14cm, 5 1/2"

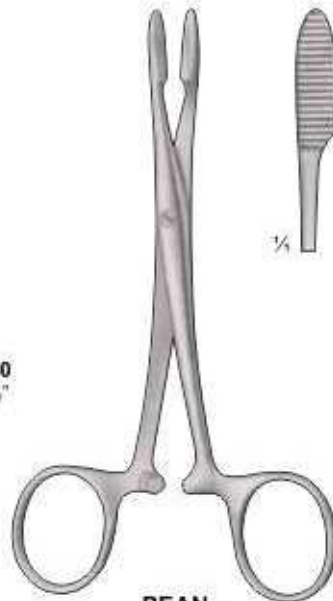

**PEAN**  
Z-17-334-125



**Z-17-335-165**  
16.5cm, 6 1/2"

**Z-17-336-185**  
18.5cm, 7 1/4"

**PEAN**

**SPONGE & DRESSING FORCEPS**

Anatomische pinzetten, Schwammzange  
Pinzas de disección, Pinza para tapones

Marteaux-percuteurs, Pince pour éponges  
Pinze per dissezione, Pinza per tamponi e sponge

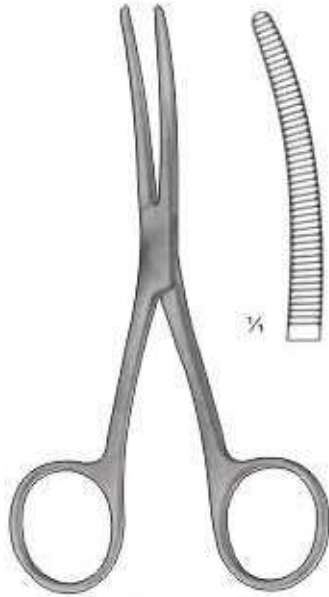

**BRYANT**  
Z-17-337-130  
13cm, 5 1/4"



**LISTER**  
Sinus Forceps

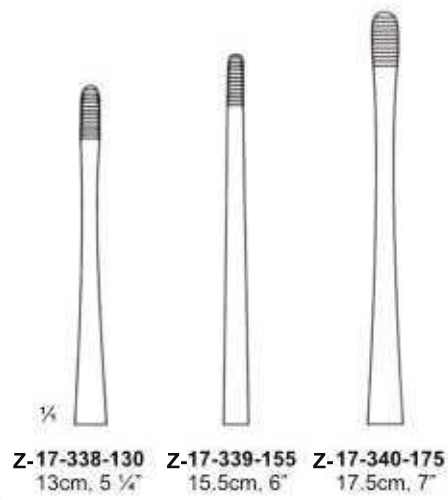

**Z-17-338-130**  
13cm, 5 1/4"

**Z-17-339-155**  
15.5cm, 6"

**Z-17-340-175**  
17.5cm, 7"

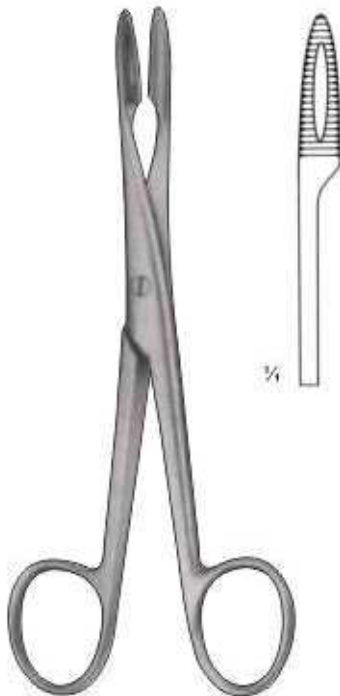

With Ratchet  
**Z-17-341-145**  
14.5cm, 5 3/4"

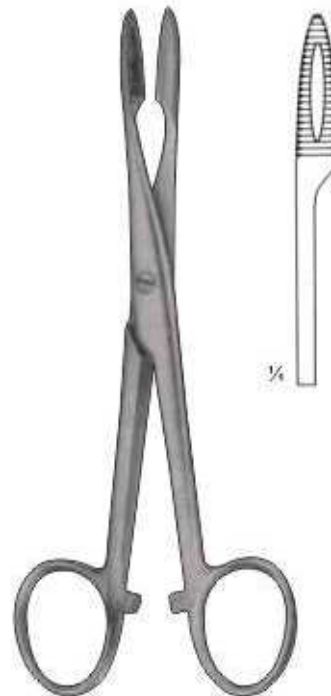

With Ratchet  
**Z-17-342-145**  
14.5cm, 5 3/4"

**SPONGE & DRESSING FORCEPS**

Anatomische pinzetten, Schwammzange  
Pinzas de disección, Pinza para tapones

Marteaux-percuteurs, Pince pour éponges  
Pinze per dissezione, Pinza per tamponi e sponge

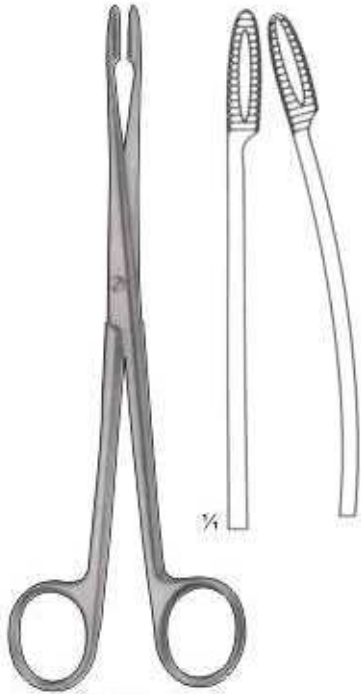

**GROSS**  
With Ratchet  
Z-17-343-200  
20cm, 8"

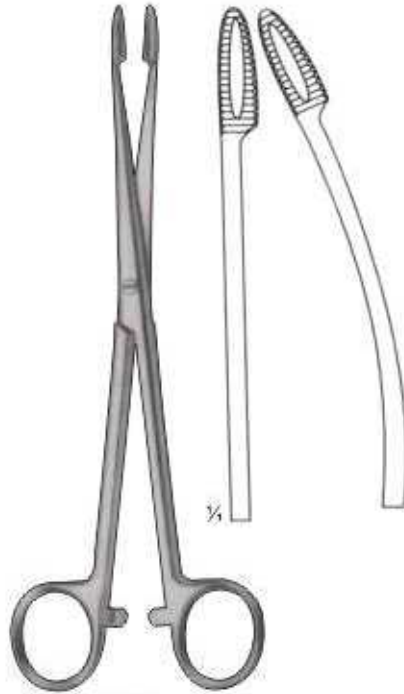

**GROSS**  
With Ratchet  
Z-17-344-180  
18cm, 7"

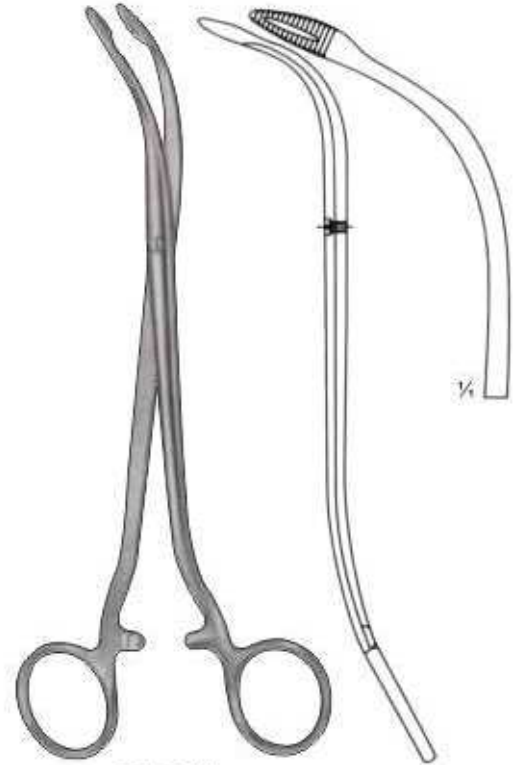

**DUPLAY**  
Z-17-345-190  
19cm, 7 1/2"



**GROSS**  
Without Ratchet  
Z-17-346-200  
20cm, 8"

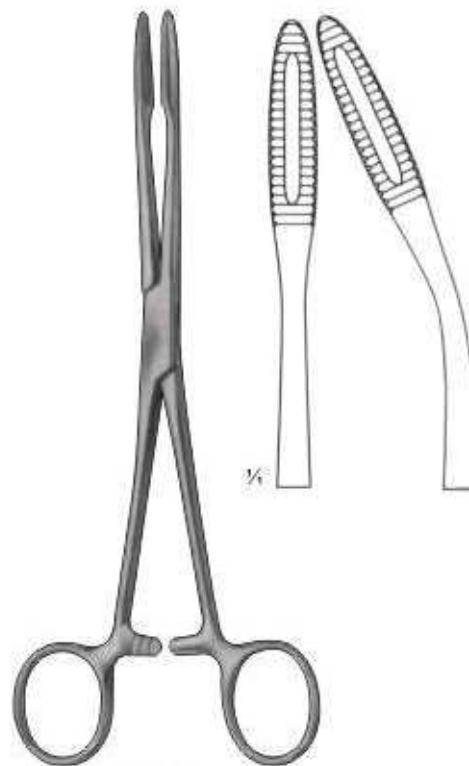
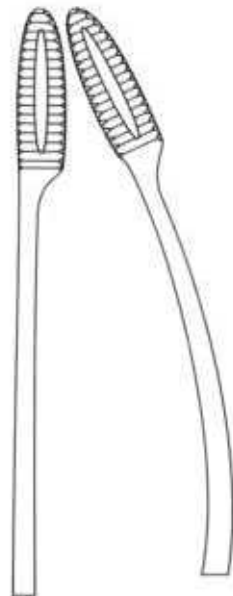

**GROSS**  
With Ratchet  
Z-17-347-200  
20cm, 8"

Arterienklemmen  
Pinzas hemostaticas

Pinces hemostatiques  
Pinze emostatiche

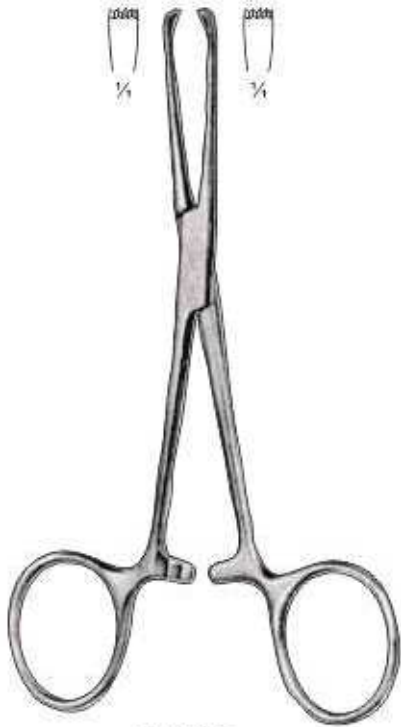

**TUFFIER**  
Z-17-348-130  
13.0 cm, 5"

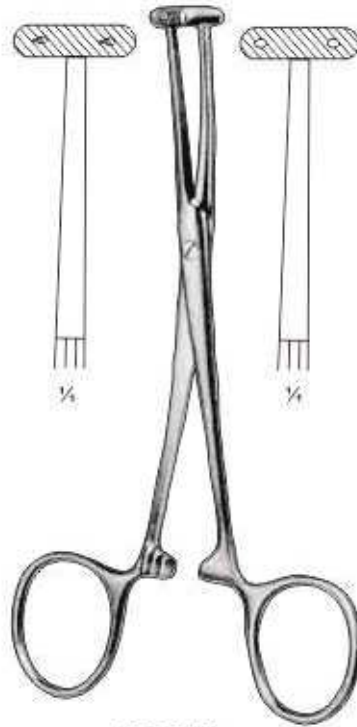

**MARTEL**  
Z-17-349-140  
14.0 cm, 5 1/2"

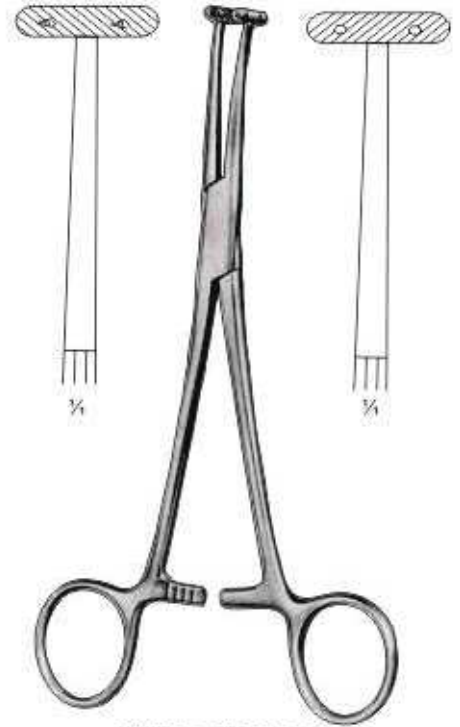

**WILLET-MARTEL**  
Z-17-350-190  
19.0 cm, 7 1/2"



**Z-17-351-150**  
15 cm, 4 3/4"  
Slight Curve

**PRATT**



**Z-17-352-155**  
15.5 cm, 6"  
Straight

**PENNINGTON / SIEZING**



**Z-17-353-200**  
20 cm, 8"  
Straight



**CHAPUT**  
Z-17-354-130  
13.0 cm, 5"

**SPONGE & DRESSING FORCEPS**

Anatomische pinzetten, Schwammzange  
Pinzas de disección, Pinza para tapones

Marteaux-percuteurs, Pince pour éponges  
Pinze per dissezione, Pinza per tamponi e sponge

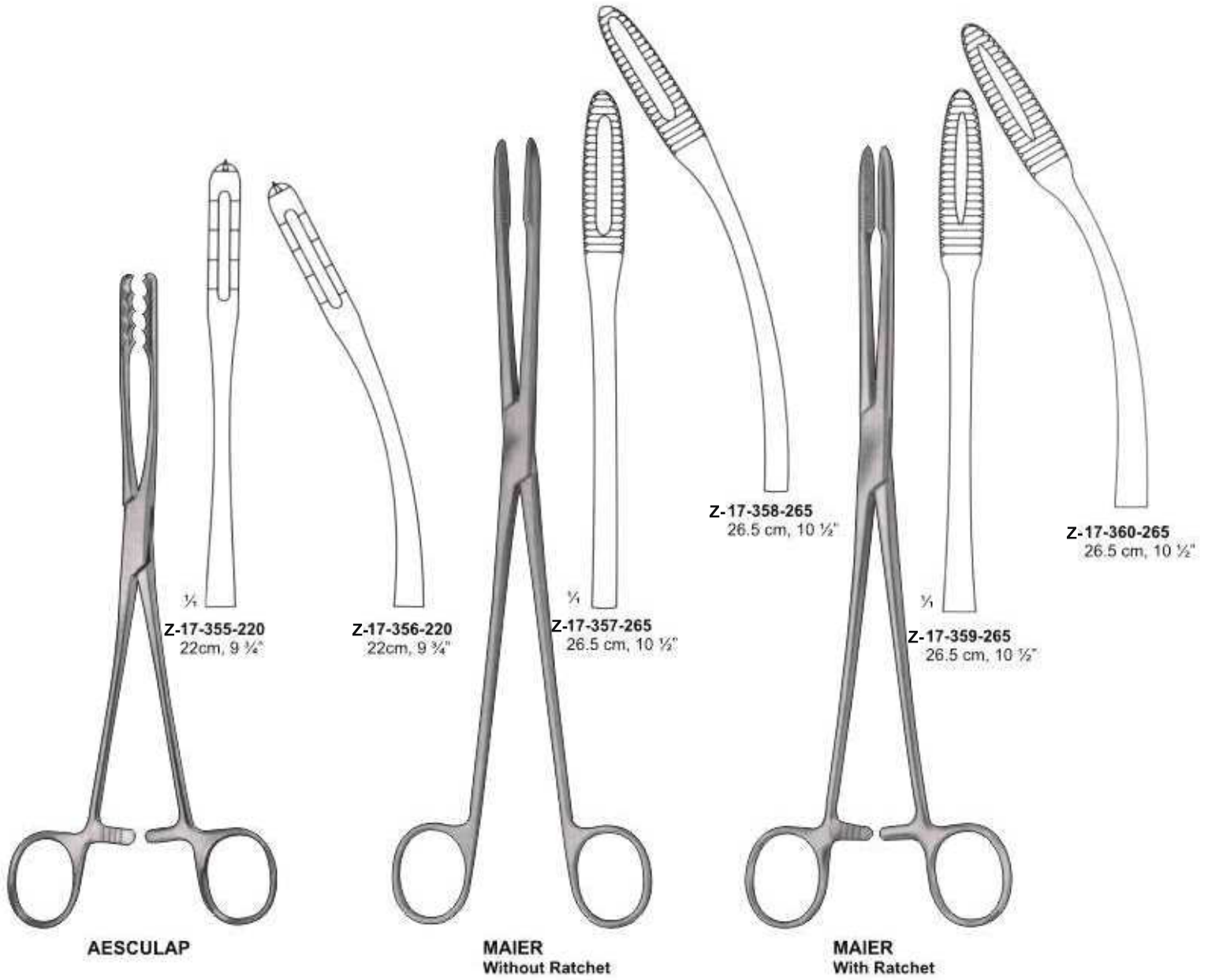

Anatomische pinzetten, Schwammzange  
Pinzas de disección, Pinza para tapones

Marteaux-percuteurs, Pince pour éponges  
Pinze per dissezione, Pinza per tamponi e sponge

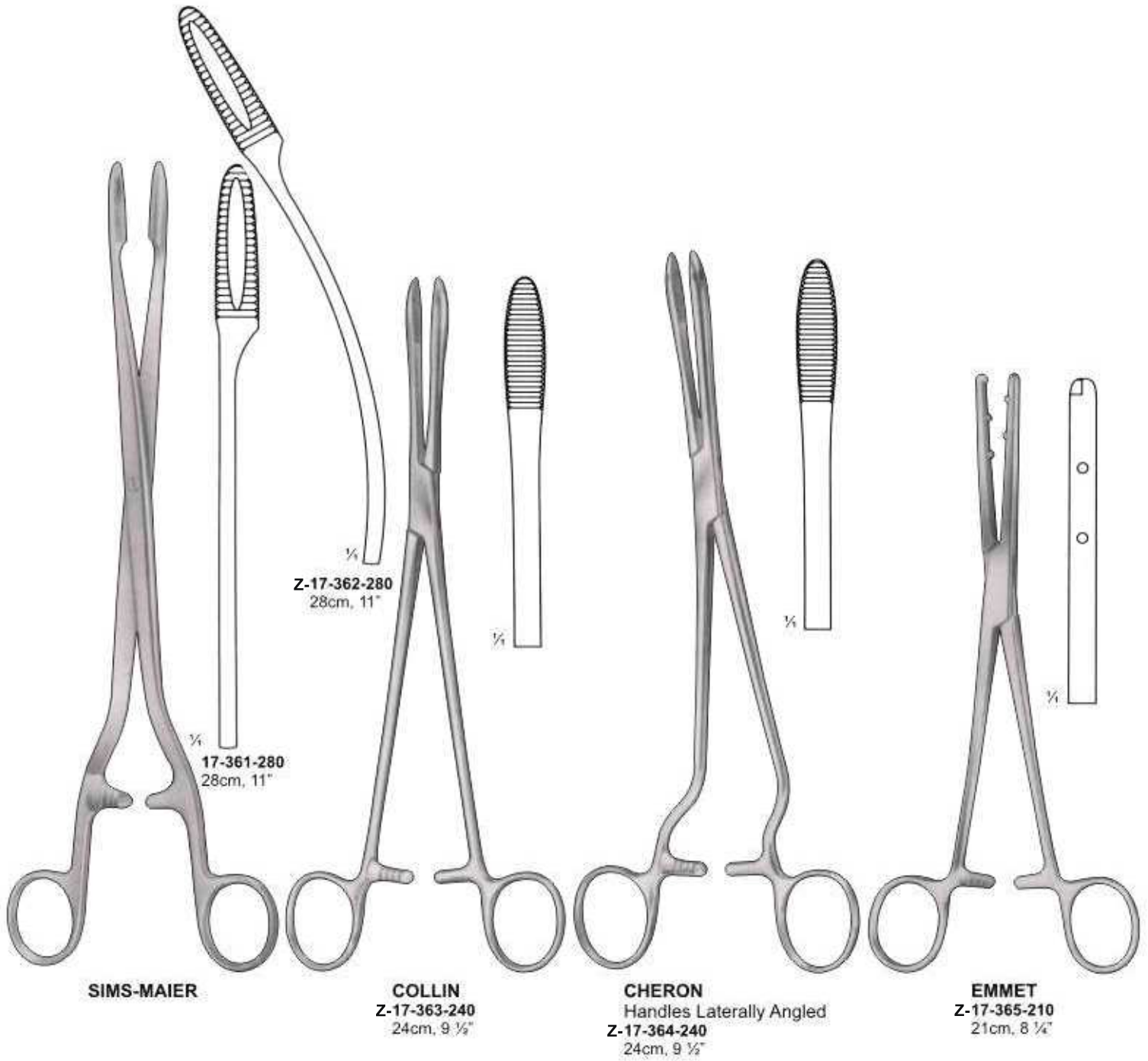



**Z-17-366-155**  
15.5 cm, 6"

**Z-17-367-155**  
15.5 cm, 6"

**HERZ**



**Z-17-368-150**  
4 x 5 teeth  
15 cm, 6"

**JACKSON**

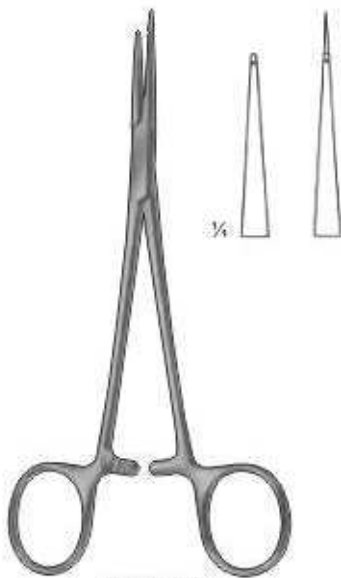

**Z-17-369-150**  
15cm, 6"

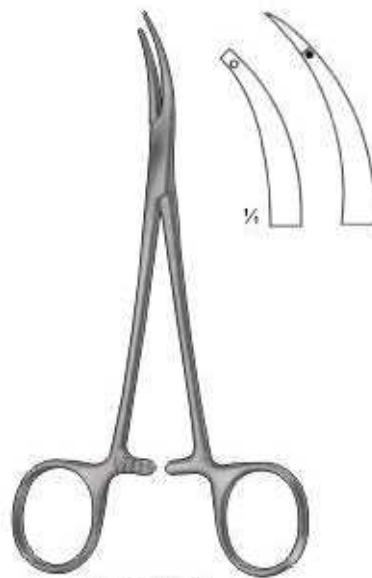

**Z-17-370-150**  
15cm, 6"



**Z-17-371-120**  
12cm, 5"

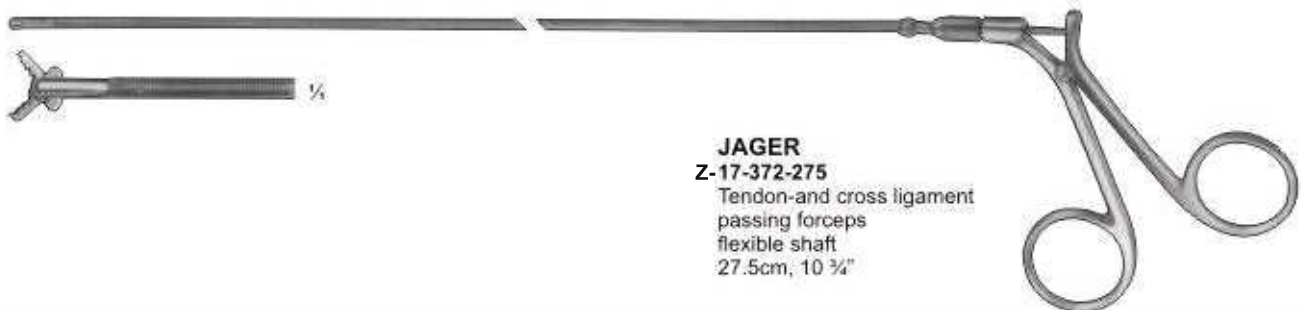

**JAGER**  
**Z-17-372-275**  
Tendon and cross ligament  
passing forceps  
flexible shaft  
27.5cm, 10 3/4"

Schwammzange  
 Pinza para tapones

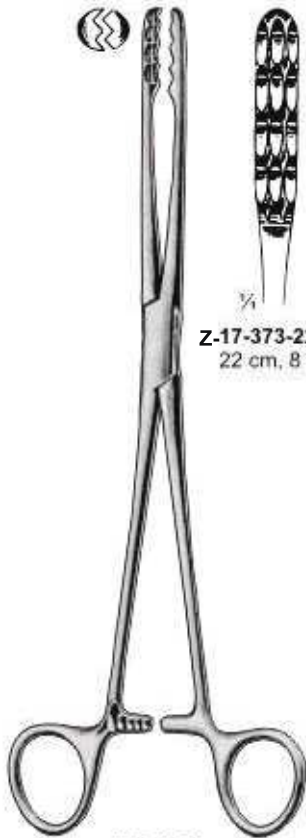

ULRICH

Z-17-373-220  
 22 cm, 8 3/4"

Z-17-374-250  
 25 cm, 10"  
 Z-17-375-270  
 27 cm, 11"



ULRICH

Z-17-376-220  
 22 cm, 8 3/4"

Z-17-377-250  
 25 cm, 10"  
 Z-17-378-270  
 27 cm, 11"



HEYWOOD SMITH  
 Z-17-379-250  
 25 cm, 10"



FLETCHER

Z-17-380-240  
 24 cm, 9 1/2"

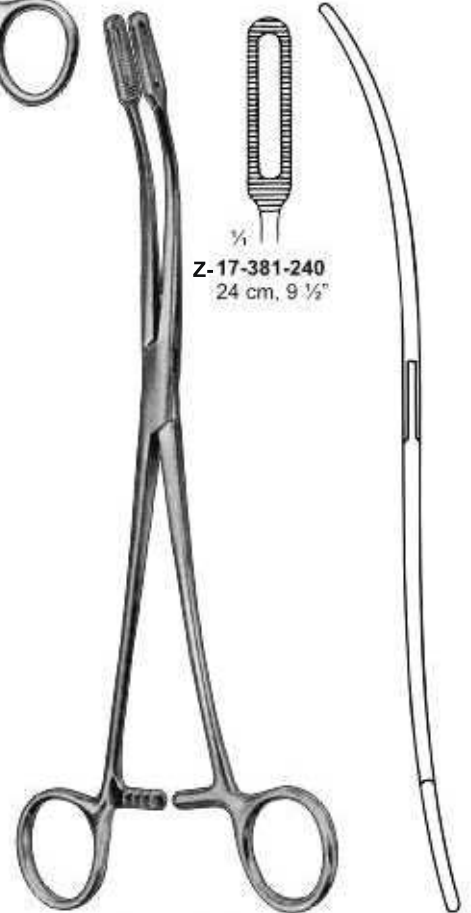

FLETCHER

Z-17-381-240  
 24 cm, 9 1/2"



**SPONGE FORCEPS**

Schwammzange  
Pinza para tapones

Pince pour éponges  
Pinza per tamponi e sponge

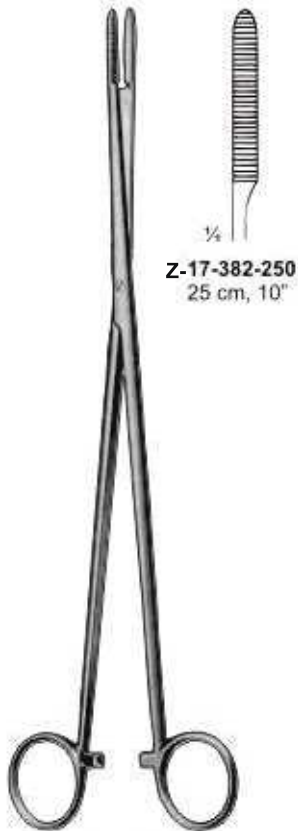

Z-17-382-250  
25 cm, 10"

PELKMANN



Z-17-383-250  
25 cm, 10"

PELKMANN



Z-17-384-205  
20.5 cm, 8"

DUPLAY



Z-17-385-205  
20.5 cm, 8"

DUPLAY

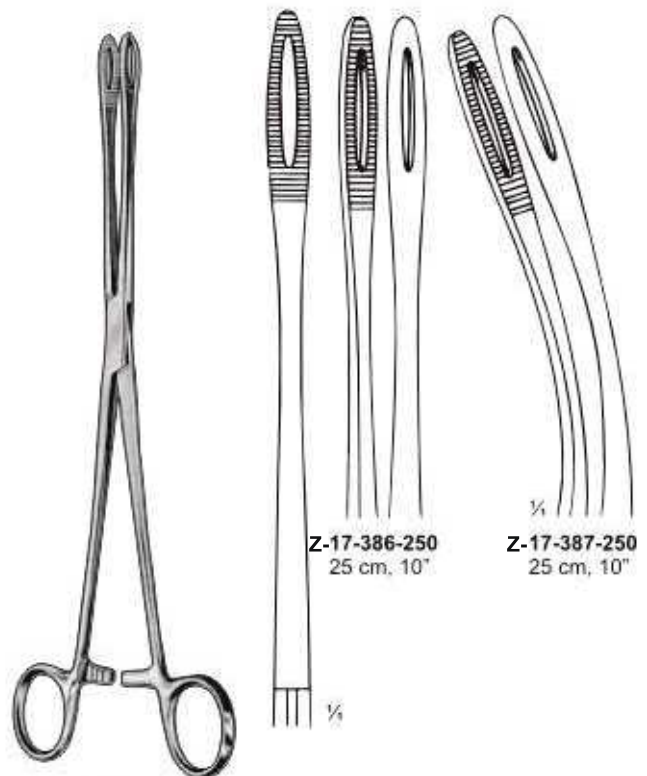

Z-17-386-250  
25 cm, 10"

FOERSTER-BALLENGER

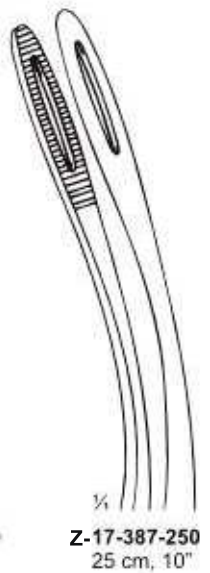

Z-17-387-250  
25 cm, 10"

Schwammzange  
 Pinza para tapones

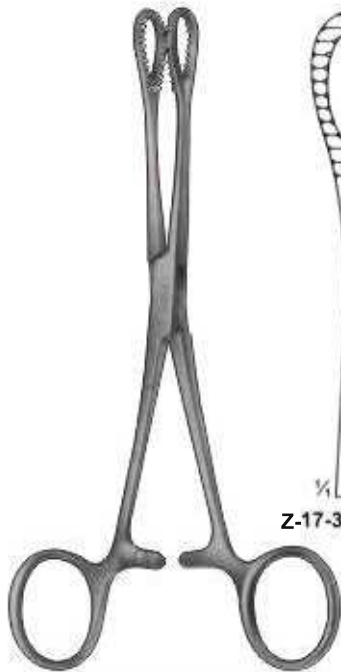

Z-17-389-180



Z-17-390-180



Z-17-392-180  
 18cm, 7"

**RAMPLEY**  
 Z-17-391-180

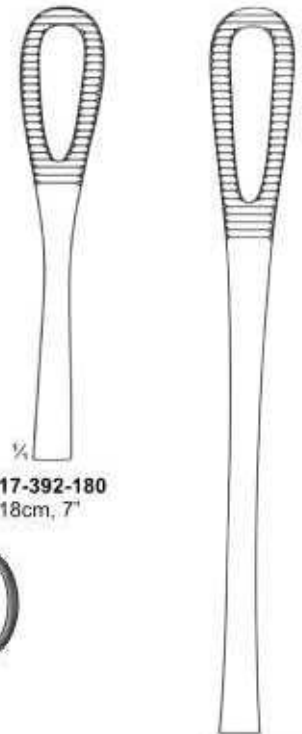

Z-17-393-250  
 25cm, 10"



**FOERSTER**

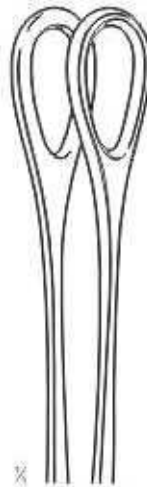

Z-17-394-25  
 25.0cm 10"  
 Round



Z-17-395-18  
 18.0cm 7"  
 Z-17-396-20  
 20.0cm 8"  
 Z-17-397-25  
 25.0cm 10"  
 Round

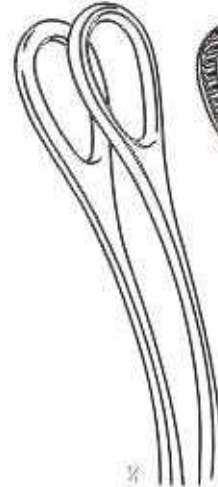

Z-17-398-25  
 25.0cm 10"  
 Round

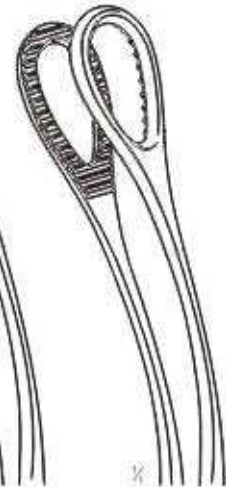

Z-17-399-18  
 18.0cm 7"  
 Z-17-400-20  
 20.0cm 8"  
 Z-17-401-25  
 25.0cm 10"  
 Round

**SPONGE & DRESSING FORCEPS**

Anatomische pinzetten, Schwammzange  
Pinzas de disección, Pinza para tapones

Marteaux-percuteurs, Pince pour éponges  
Pinze per dissezione, Pinza per tamponi e sponge



**COLLIN**  
Z-17-403-195

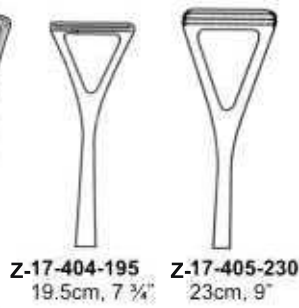

Z-17-404-195 19.5cm, 7 3/4"  
Z-17-405-230 23cm, 9"

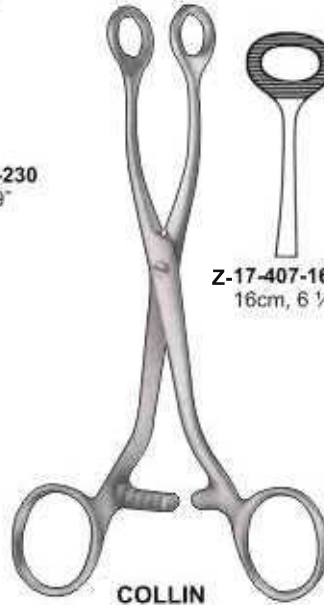

**COLLIN**  
Z-17-406-160

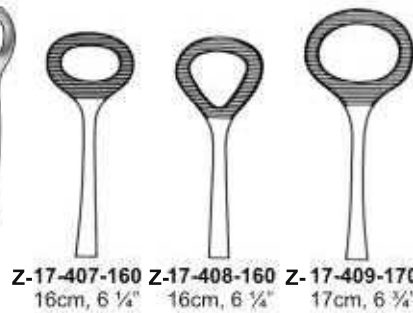

Z-17-407-160 16cm, 6 1/4"  
Z-17-408-160 16cm, 6 1/4"  
Z-17-409-170 17cm, 6 3/4"

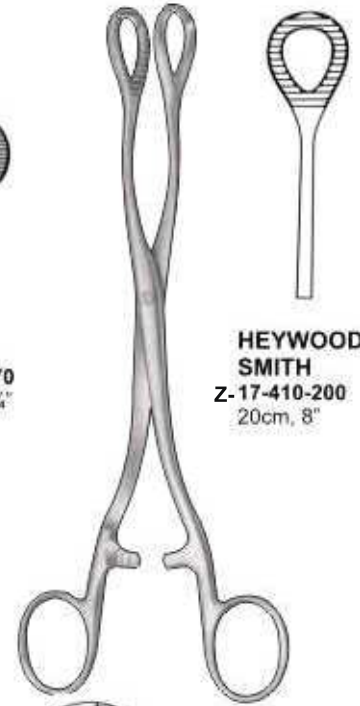

**HEYWOOD-SMITH**  
Z-17-410-200  
20cm, 8"

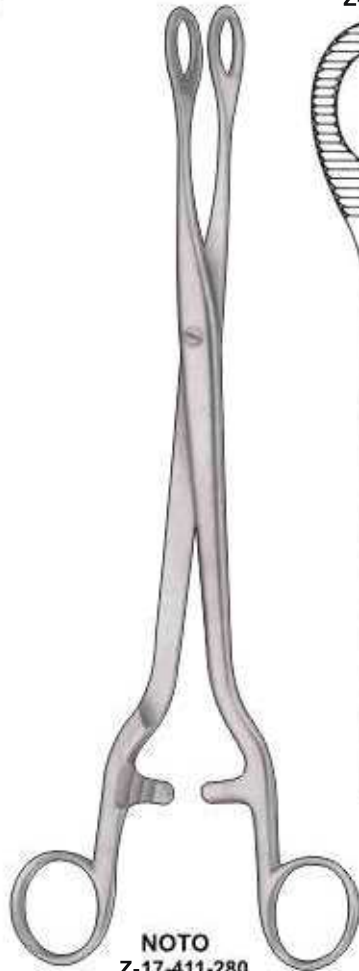

**NOTO**  
Z-17-411-280  
28cm, 11"

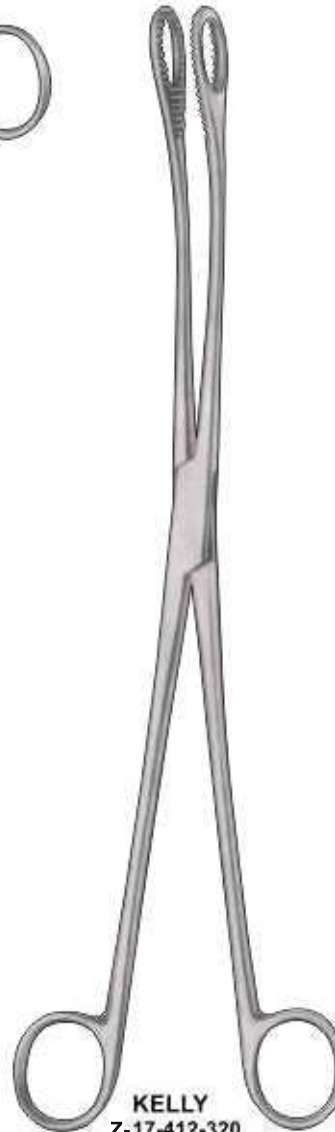

**KELLY**  
Z-17-412-320  
32cm, 12 1/2"







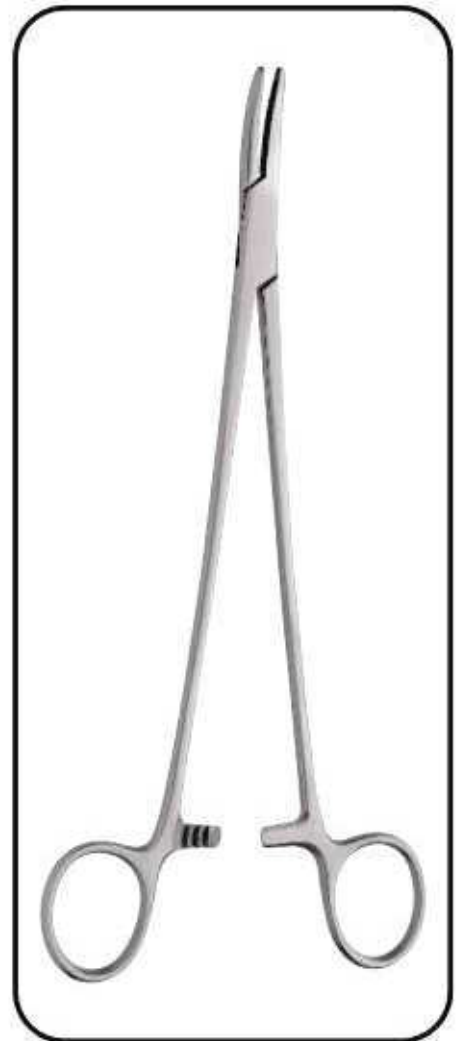

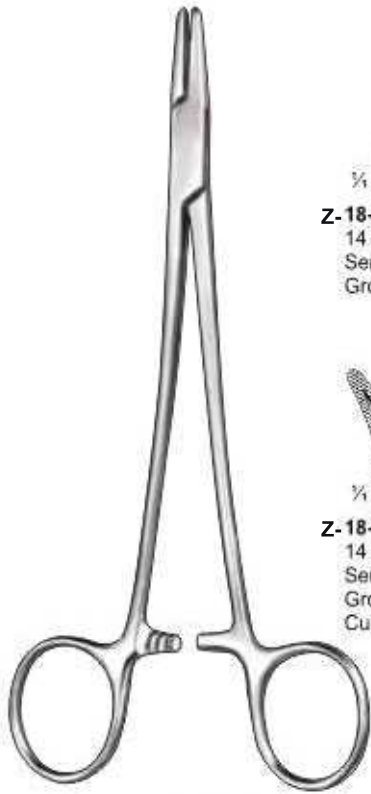







- **NEEDLE HOLDERS**
- **REVERDIN NEEDLES**

- **SUTURE INSTRUMENTS**
- **GENERAL INSTRUMENTS**





**MAYO-HEGAR**

						
<b>Z-18-001-140</b> 14 cm, 5 1/2" Serrated-Grooved	<b>Z-18-002-160</b> 16 cm, 6 1/4" Serrated-Grooved	<b>Z-18-003-180</b> 18 cm, 7" Serrated-Grooved	<b>Z-18-004-200</b> 20 cm, 8" Serrated-Grooved	<b>Z-18-005-240</b> 24 cm, 9 3/4" Serrated-Grooved	<b>Z-18-006-260</b> 26 cm, 10 1/4" Serrated-Grooved	<b>Z-18-007-305</b> 30.5 cm, 12" Serrated-Grooved
						
<b>Z-18-008-140</b> 14 cm, 5 1/2" Serrated-Grooved Curved	<b>Z-18-009-160</b> 16 cm, 6 1/4" Serrated-Grooved Curved	<b>Z-18-010-180</b> 18 cm, 7" Serrated-Grooved Curved	<b>Z-18-011-200</b> 20 cm, 8" Serrated-Grooved Curved	<b>Z-18-012-240</b> 24 cm, 9 3/4" Serrated-Grooved Curved	<b>Z-18-013-260</b> 26 cm, 10 1/4" Serrated-Grooved Curved	<b>Z-18-014-305</b> 30.5 cm, 12" Serrated-Grooved Curved



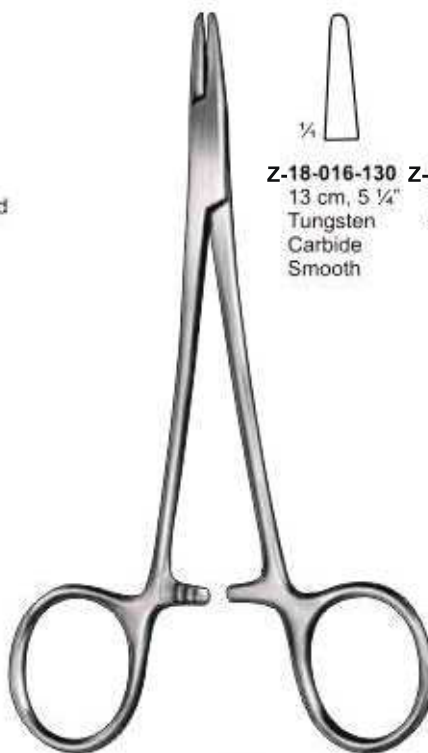

**BAUMGARTNER**

  
**Z-18-015-140**  
14 cm, 5 1/2"  
Serrated-Solid



**WEBSTER**

  
**Z-18-016-130**  
13 cm, 5 1/4"  
Tungsten Carbide Smooth

  
**Z-18-017-130**  
13 cm, 5 1/4"  
Smooth



**BROWN**

  
**Z-18-018-130**  
13 cm, 5 1/4"  
Serrated-Solid

  
**Z-18-019-190**  
19 cm, 7 1/2"  
Serrated-Solid

Nadelhalter  
 Porta-agujas

Porte-agujas  
 Portaghi



**Z-18-020-180**  
 18 cm, 7"



**Z-18-021-260**  
 26 cm, 10 1/4"

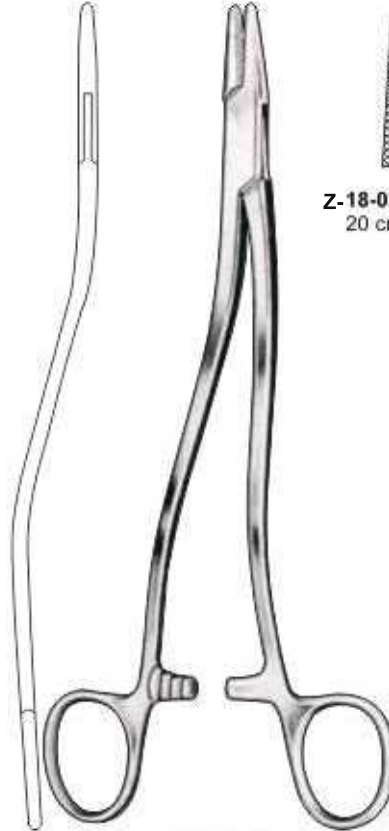

**Z-18-022-200**  
 20 cm, 8"

**Z-18-023-240**  
 24 cm, 9 1/4"

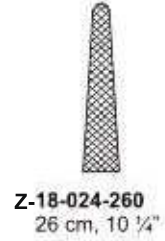

**Z-18-024-260**  
 26 cm, 10 1/4"

**SAROT**

**BOZEMANN**



**BABY CRILE-WOOD**  
**Z-18-025-150** 15 cm, 6"



**CRILE-WOOD**

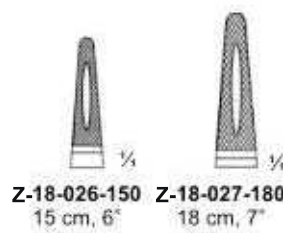

**Z-18-026-150** 15 cm, 6"    **Z-18-027-180** 18 cm, 7"



**CARROLL**  
**Z-18-028-150** 15 cm, 6"



**JAMESON**  
Z-18-029-230  
23.5 cm, 9 1/4"



**FINOCCHIETTO**  
Z-18-030-270  
27 cm, 10 3/4"

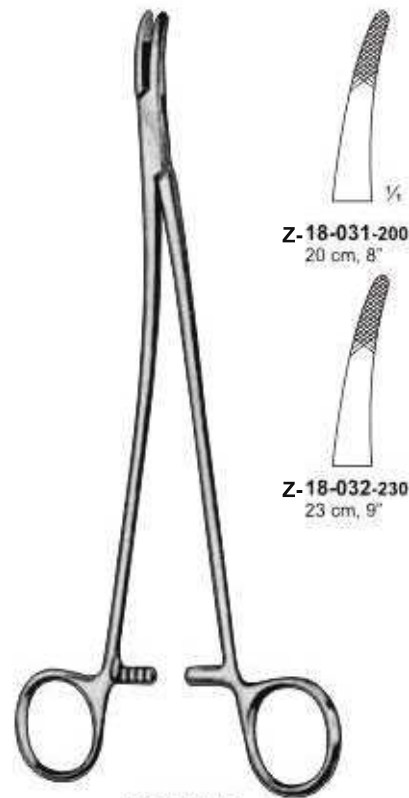

**Z-18-031-200**  
20 cm, 8"

**Z-18-032-230**  
23 cm, 9"

**STRATTE**

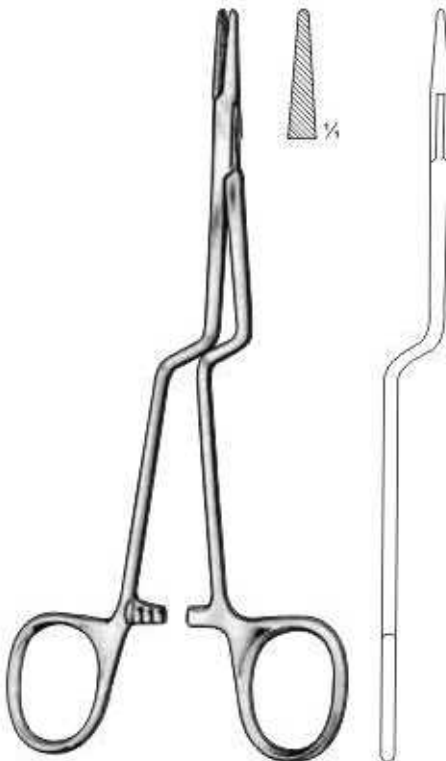

**JACOBSON**  
Z-18-033-180  
18 cm, 7"

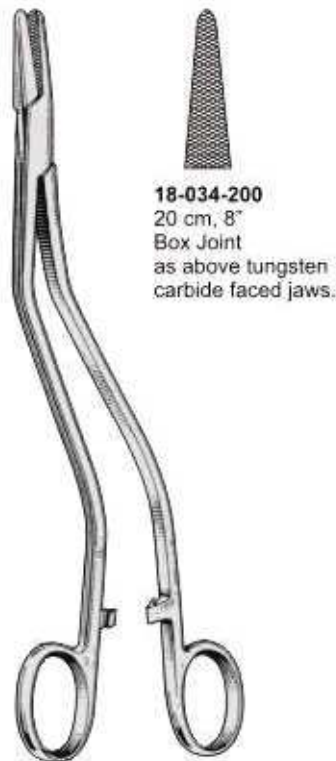

**18-034-200**  
20 cm, 8"  
Box Joint  
as above tungsten  
carbide faced jaws.

**THOMSON WALKER**

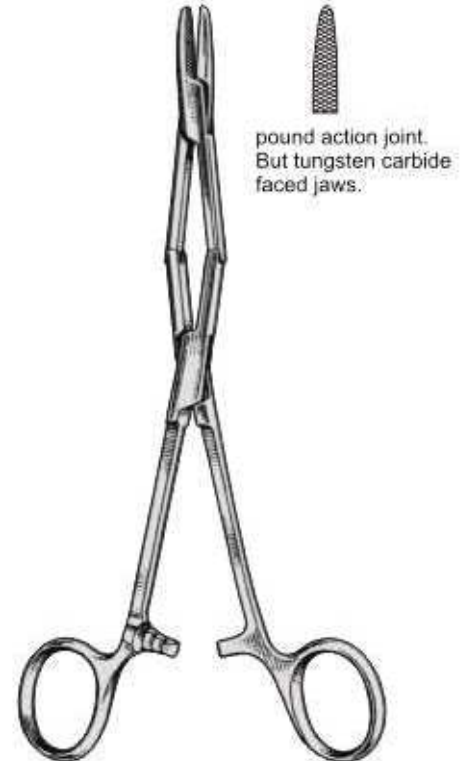

pound action joint.  
But tungsten carbide  
faced jaws.

**NAUNTUN MORGAN**  
Z-18-035-180 18 cm, 7"  
Z-18-036-250 25 cm, 10"

Nadelhalter  
 Porta-agujas

Porte-agujas  
 Portaghi



**M.G.H.**  
 (Mass. General Hospital)  
 Z-18-037-170  
 17 cm, 6 3/4"



**ADSON**  
 Z-18-038-180  
 18 cm, 7"



**HEANEY**  
 Z-18-039-210  
 21 cm, 8 1/4"



**Z-18-040-130** **Z-18-041-180**  
 13 cm, 5 1/4" 18 cm, 7"

**BROWN**



**NEW ORLEANS**  
 Z-18-042-180  
 18 cm, 7"

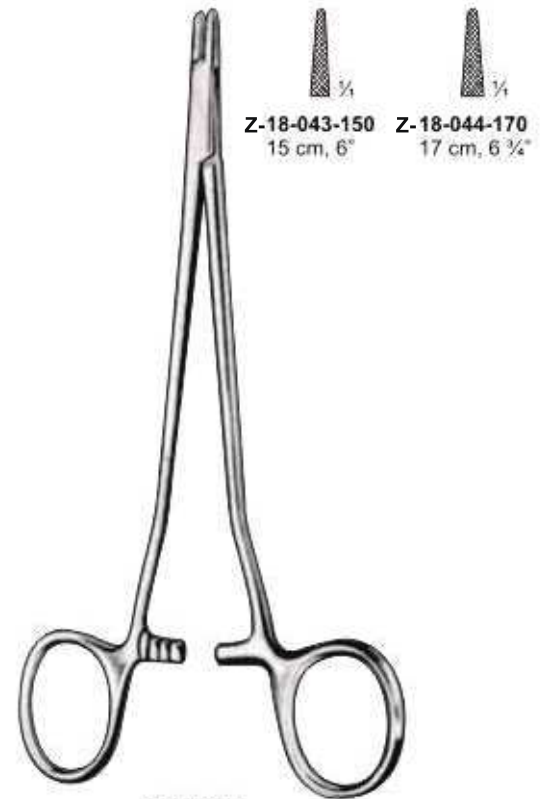

**SENNING**  
 (Schwed. Model)





**WERTHEIM**  
Z-18-045-200 20 cm, 8"  
Z-18-046-240 24 cm, 9 1/2"

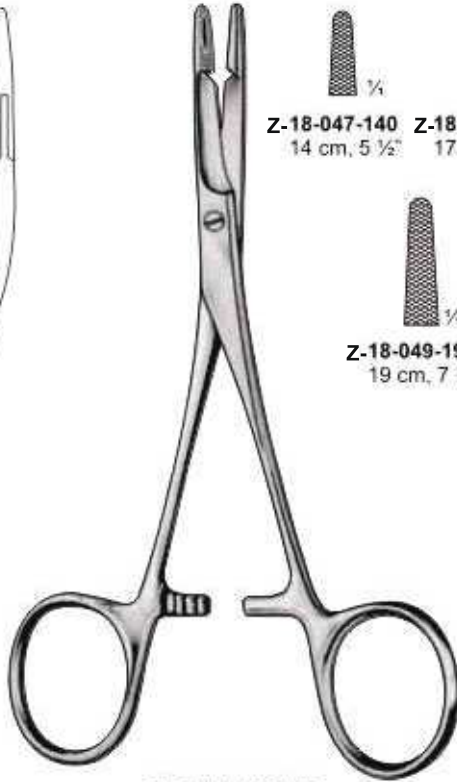

Z-18-047-140 14 cm, 5 1/2"    Z-18-048-170 17 cm, 6 1/4"  
Z-18-049-190 19 cm, 7 1/2"



**GILLIES**  
Z-18-050-160 16 cm, 6 1/4"



**MASSON**  
Z-18-051-270 27 cm, 10 3/4"

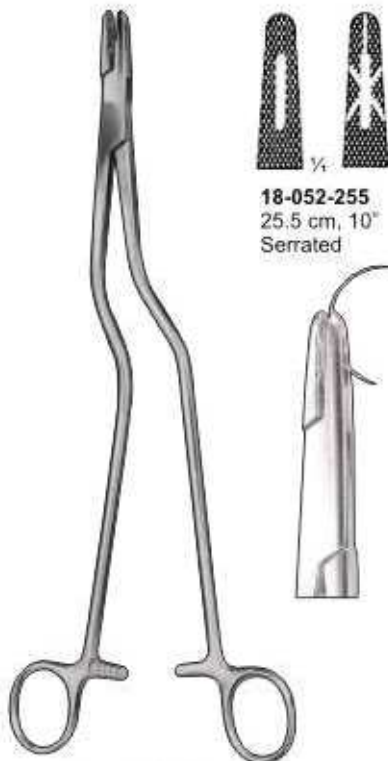

**MASSON-LUETHY**

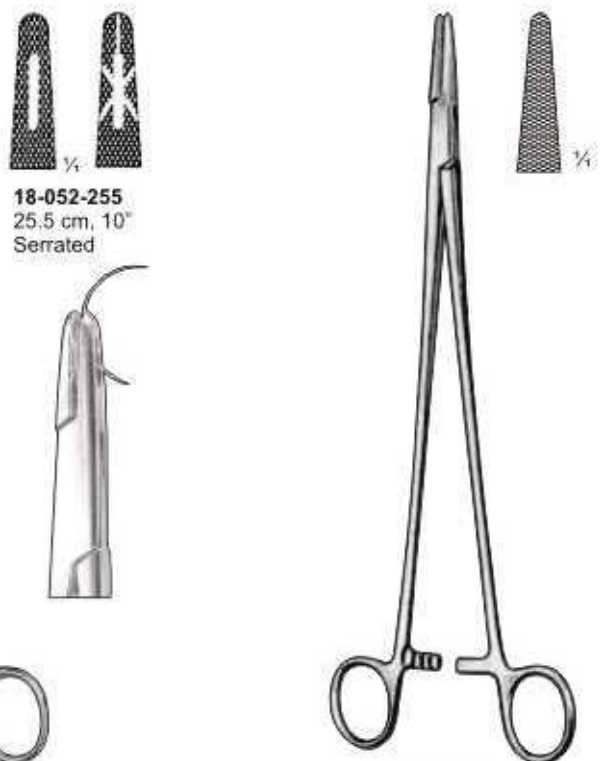

**WANGENSTEEN**  
Z-18-053-270 27 cm, 10 3/4"

Nadelhalter  
 Porta-agujas

Porte-agujas  
 Portaghi

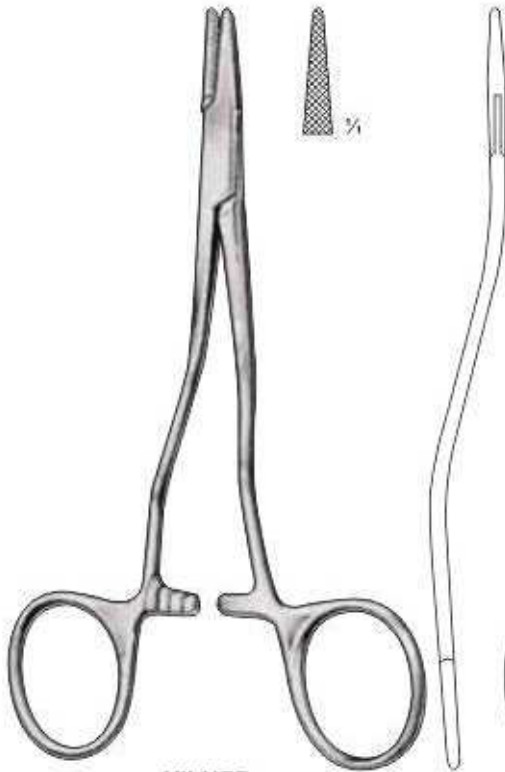

**KILNER**  
 Z-18-054-130  
 13 cm, 5 1/2"

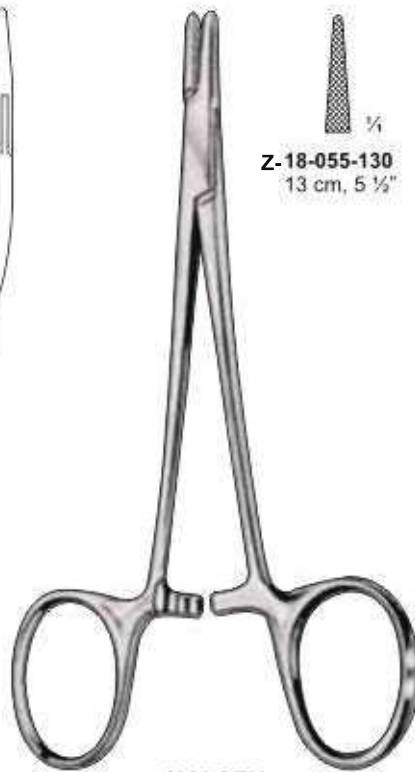

**HALSEY**

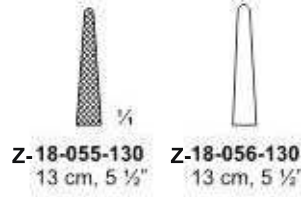

**Z-18-055-130**  
 13 cm, 5 1/2"

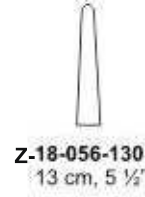

**Z-18-056-130**  
 13 cm, 5 1/2"

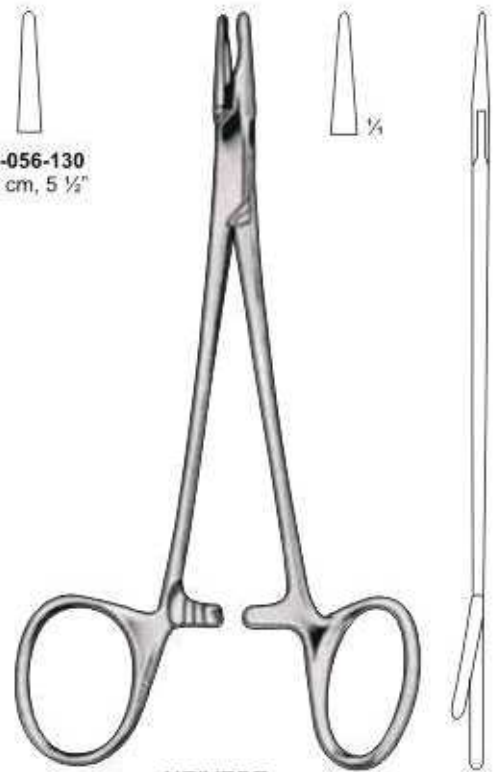

**NEIVERT**  
 Z-18-057-130  
 13 cm, 5 1/2"

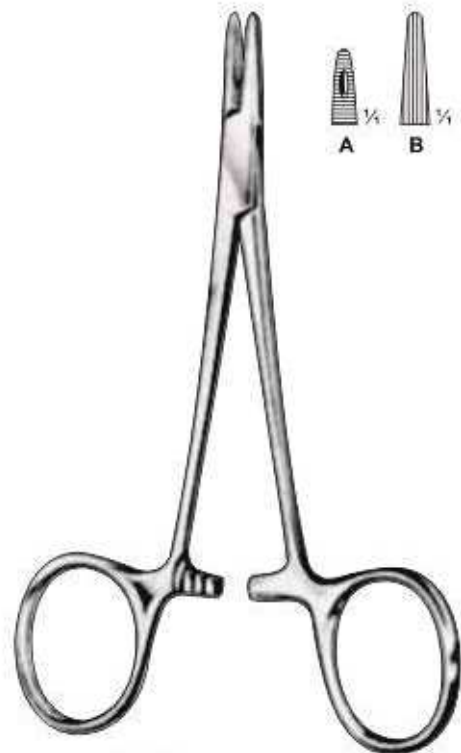

**DERF**  
 Z-18-058-120 12 cm, 5" A  
 Z-18-059-120 12 cm, 5" B

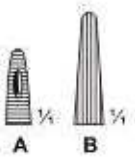

**COLLIER**  
 Z-18-060-125  
 12.5 cm, 5"

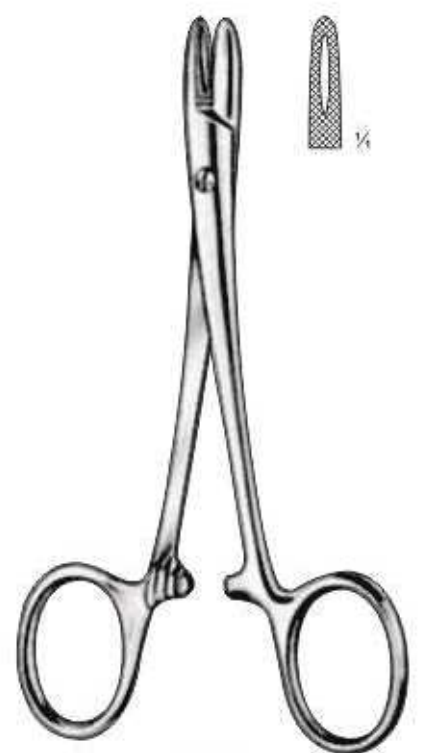

**DOYEN**  
 Z-18-061-125  
 12.5 cm, 5"





**HEGAR-BAUMGARTNER**  
Z-18-062-145  
14.5 cm, 5 3/4"



**CRILE-MURRAY**  
Z-18-063-150  
15 cm, 6"



**METZENBAUM**  
Z-18-064-185  
18.5 cm, 7 1/4"

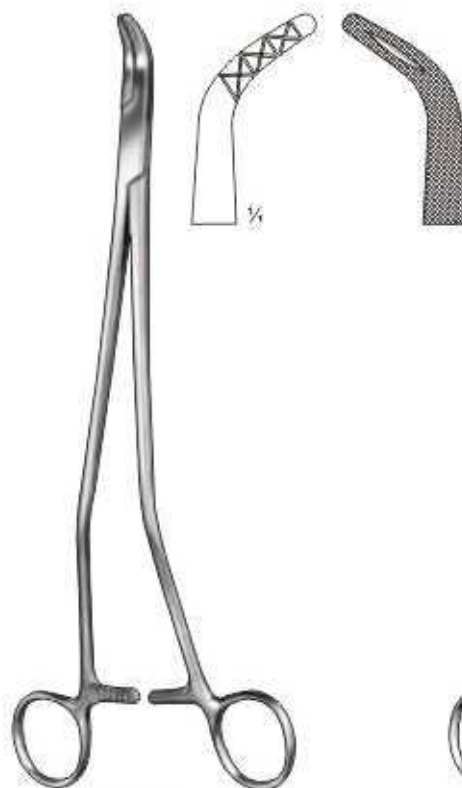

**JOHNSON**  
Z-18-065-270  
27 cm, 10 3/4"

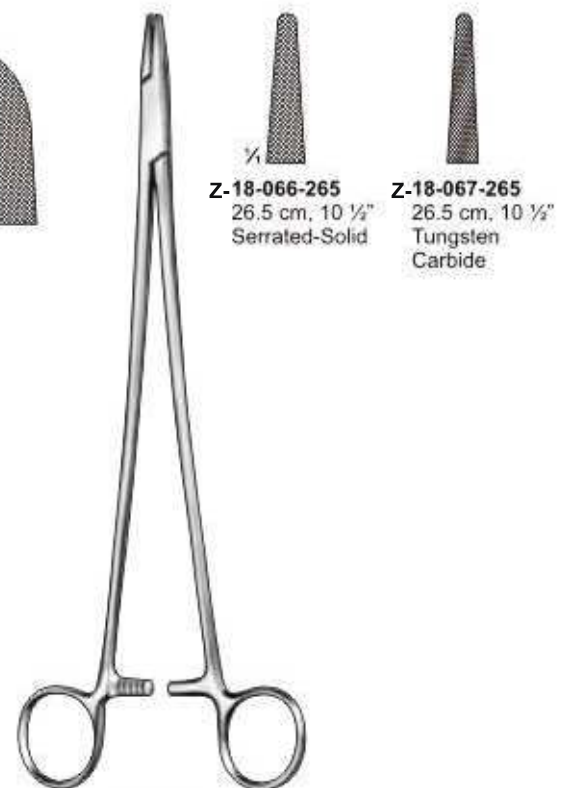

**WANGENSTEEN**  
Serrated-Solid

Z-18-066-265  
26.5 cm, 10 1/2"  
Serrated-Solid

Z-18-067-265  
26.5 cm, 10 1/2"  
Tungsten Carbide

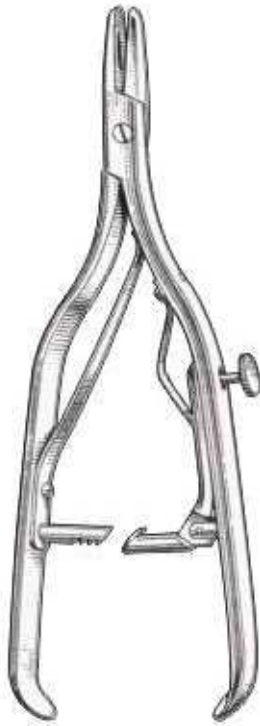

**MAYO ROCHESTER**  
Z-18-068-180 18 cm, 8"  
Z-18-069-230 23 cm, 9"  
button release, screw joint.

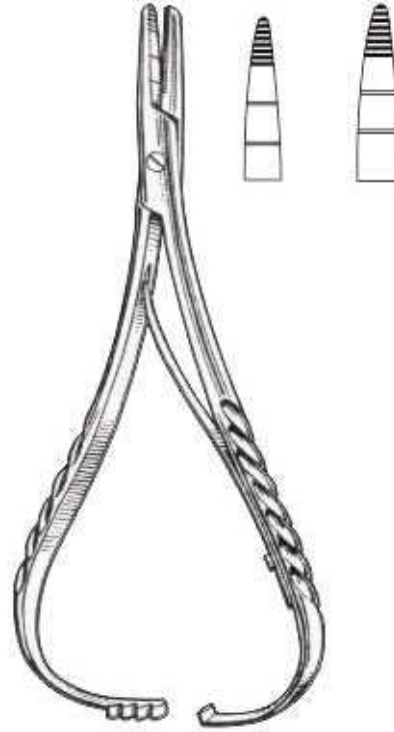

**MACPHAIL**  
Z-18-070-150 15 cm, 6"  
Z-18-071-180 18 cm, 7"  
Z-18-072-200 20 cm, 8"  
lined with copper.



**MATHIEU**

¼  
Z-18-073-140 14 cm, 5 ½"  
Z-18-074-170 17 cm, 6 ¼"  
Z-18-075-200 20 cm, 8"



**MATHIEU**

¼  
Z-18-076-140 14 cm, 5 ½"  
Z-18-077-165 16.5 cm, 6 ½"



**TOENNIS**  
Z-18-078-185  
18.5 cm, 7 1/4"



**CRILE**  
Z-18-079-150  
15 cm, 6"



**CASTROVIEJO  
OLSEN HEAGER /  
Needle Holders / Scissors**  
Z-18-080-145 14.5 cm, 5 3/4"  
Z-18-081-150 15.0 cm, 6"



**BOYNTON**  
Z-18-082-120  
12 cm, 5"











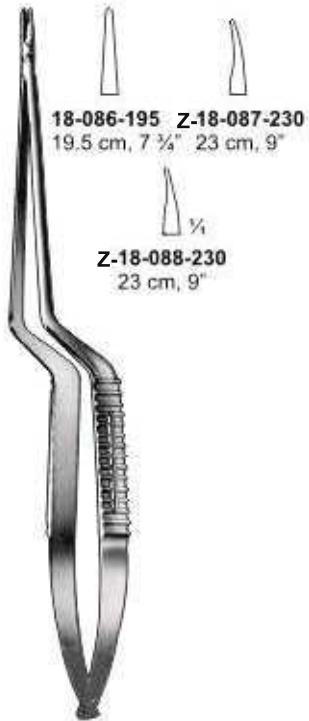

**ARRUGA**  
Z-18-083-160 16 cm, 6 1/4" Str.  
Z-18-084-160 16 cm, 6 1/4" Cvd.



**LICHTENBERG**  
Z-18-085-200 20 cm, 8"

Nadelhalter  
 Porta-agujas

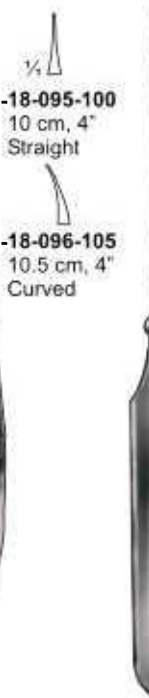
Porte-agujas  
 Portaghi

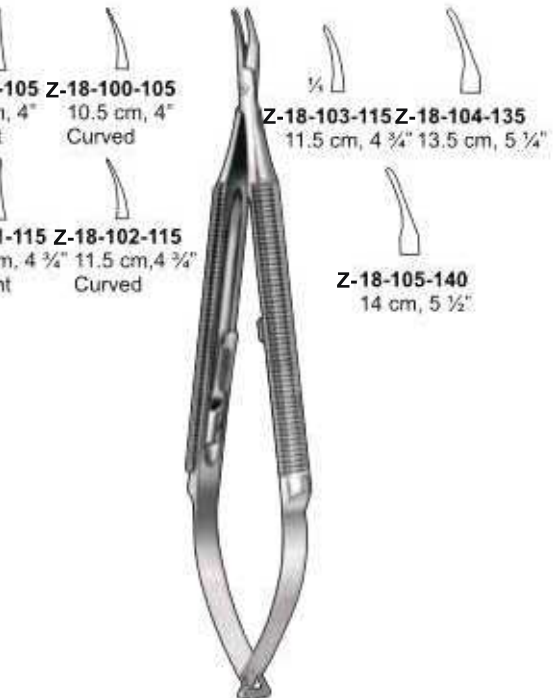
 <p>18-086-195 Z-18-087-230          19.5 cm, 7 3/4" 23 cm, 9"</p>  <p>Z-18-088-230          23 cm, 9"</p>					
<p><b>MICRO</b></p>	<p><b>MICRO</b>  <b>Z-18-089-160</b>          16 cm, 6 1/4"</p>	<p><b>CASTROVIEJO</b>  <b>Z-18-090-120</b>          12 cm, 5"</p>	<p><b>CASTROVIEJO</b>  <b>Z-18-091-120</b>          12 cm, 5"</p>	<p><b>BARRAQUER</b>  <b>Z-18-092-140</b>          14 cm, 5 1/2"          Curved, Smooth</p>	<p><b>BARRAQUER/WITH CATCH</b>  <b>Z-18-093-140</b>          14 cm, 5 1/2"          Curved, Smooth</p>
					
<p><b>KALT</b>  <b>Z-18-094-135</b>          13.5 cm, 5 1/4"</p>	<p><b>BARRAQUER-TROUTMAN</b></p>	<p><b>ARRUGA</b></p>	<p><b>BARRAQUER-TROUTMAN</b></p>	<p><b>BARRAQUER</b></p>	



**MICROVASCULAR**  
Z-18-106-180 18 cm, 7"  
Z-18-107-200 20 cm, 8"  
Z-18-108-220 22 cm, 8 3/4"  
Z-18-109-250 25 cm, 10"

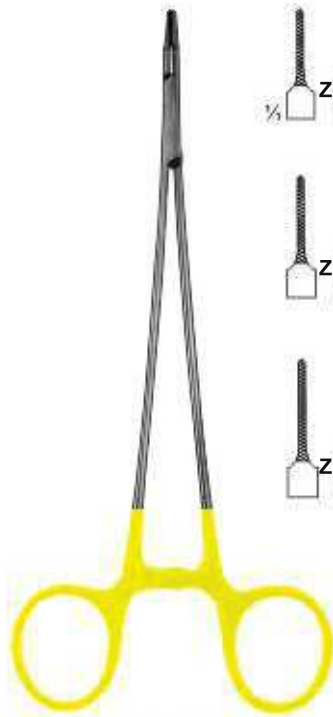

**Z-18-110-150**  
15 cm, 6"  
**Z-18-111-175**  
17.5 cm, 7"  
**Z-18-112-195**  
19.5 cm, 7 3/4"



**CRILE-WOOD**  
Z-18-113-175 17.5 cm, 7"  
Z-18-114-200 20.0 cm, 8"  
Z-18-115-220 22.0 cm, 8 3/4"  
Z-18-116-250 25.0 cm, 10"



**DE BAKEY**  
Z-18-117-180 18 cm, 7"  
Z-18-118-200 20 cm, 8"  
Z-18-119-220 22 cm, 8 3/4"  
Z-18-120-250 25 cm, 10"



**INTRACARDIAC**  
Z-18-121-180 18 cm, 7"  
Z-18-122-200 20 cm, 8"  
Z-18-123-220 22 cm, 8 3/4"  
Z-18-124-250 25 cm, 10"



**NEW ORLEANS**  
18-125-175  
17.5 cm, 7"

NEEDLE HOLDERS T.C. INSERTED



Nadelhalter  
Porta-agujas

Porte-agujas  
Portaghi



**SENNING**  
(Schwed. Model)

Z-18-126-150 15 cm, 6"  
Z-18-127-170 17 cm, 6 3/4"



**WERTHEIM**  
Z-18-128-200 20 cm, 8"  
Z-18-129-240 24 cm, 9 1/2"

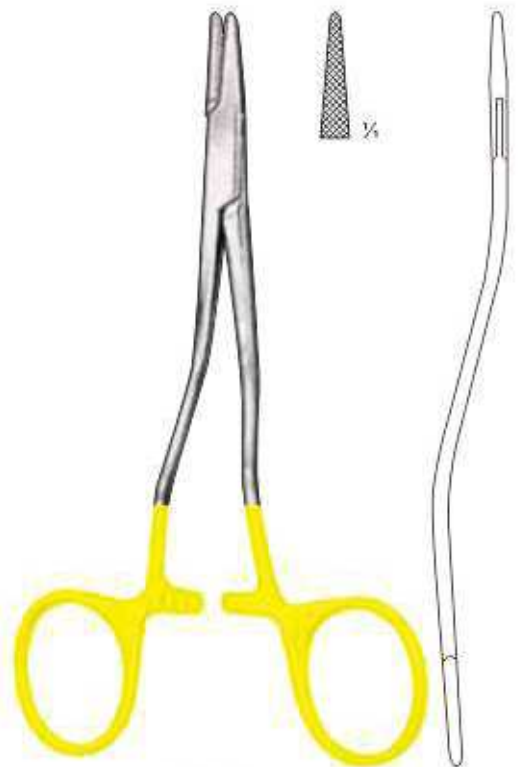

**KILNER**  
Z-18-130-130 13 cm, 5 1/2"

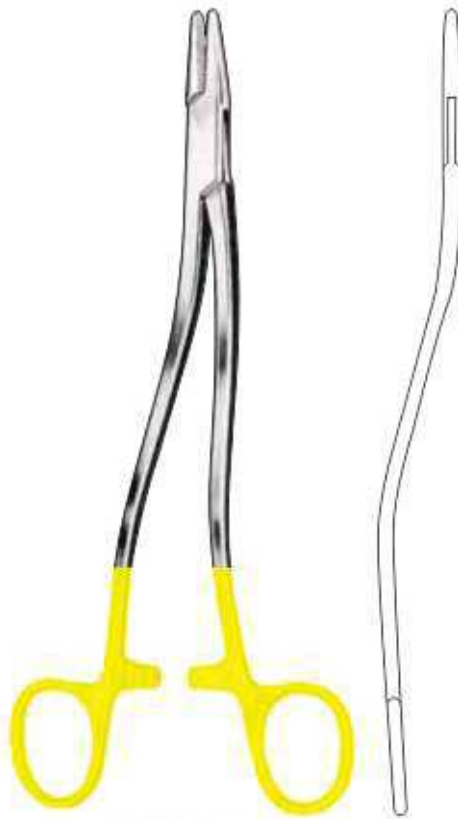

**BOZEMANN**

Z-18-131-200 20 cm, 8"  
Z-18-132-240 24 cm, 9 1/4"

Z-18-133-260 26 cm, 10 1/4"

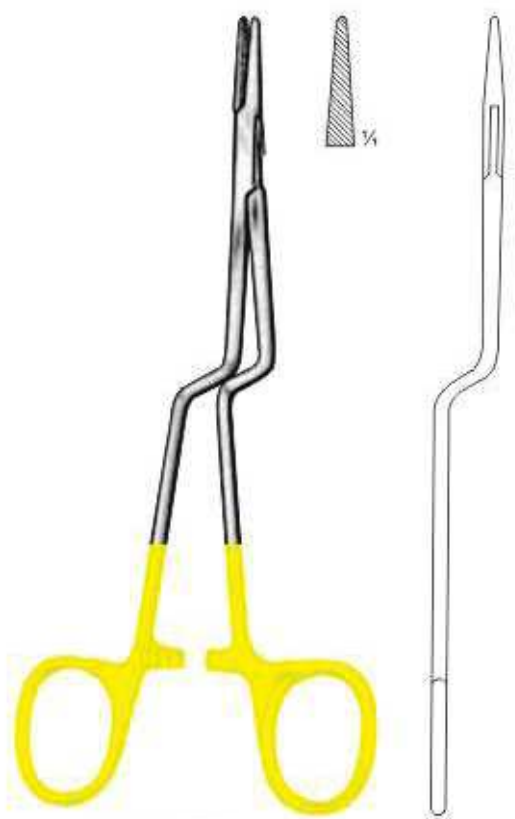

**JACOBSON**  
Z-18-134-180 18 cm, 7"





**BAUMGARTNER**  
Z-18-135-135  
13.5 cm, 5 1/4"



**BAUMGARTNER**  
Z-18-136-130  
13 cm, 5 1/4"  
Left handle



Z-18-137-140  
14 cm, 5 1/2"

Z-18-138-165  
16.5 cm, 6 1/2"

Z-18-139-180  
18 cm, 7"

**OLSEN-HEGAR**



**CRILE-WOOD**  
Z-18-140-150  
15 cm, 6"

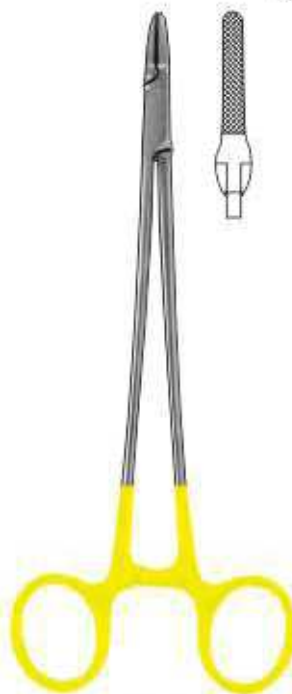

**FRENCH-EYE**  
Z-18-141-160 16 cm, 6 1/4"  
Z-18-142-180 18 cm, 7"  
Z-18-143-200 20 cm, 8"  
Z-18-144-220 22 cm, 8 3/4"  
Z-18-145-250 25 cm, 10"



**FRENCH-EYE**  
Z-18-146-152 15.2 cm, 6"  
Z-18-147-178 17.8 cm, 7"  
Z-18-148-203 20.3 cm, 8"  
Z-18-149-254 25.4 cm, 10"

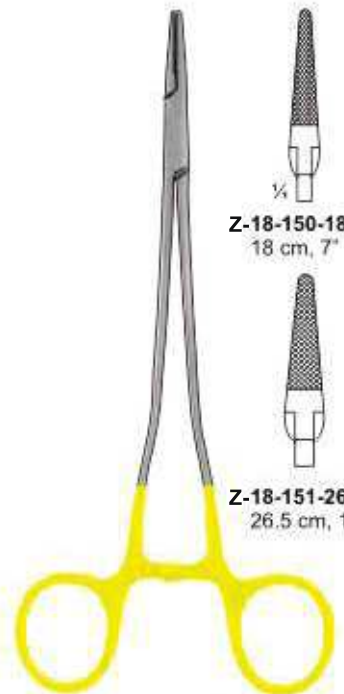

Z-18-150-180  
18 cm, 7"

Z-18-151-265  
26.5 cm, 10 1/2"

**SAROT**

NEEDLE HOLDERS T.C. INSERTED



Nadelhalter  
Porta-agujas

Porte-agujas  
Portaghi

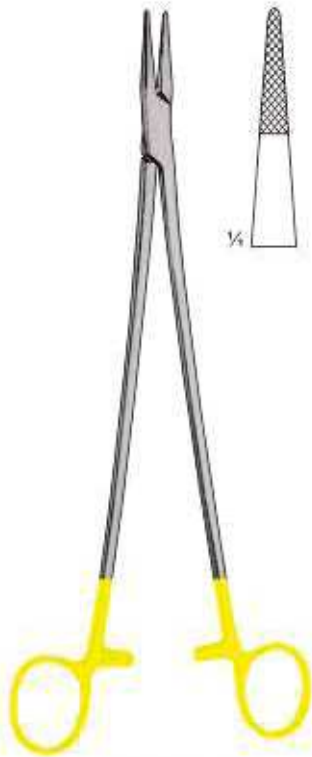

**WANGENSTEEN**  
Z-18-152-273  
27.3 cm, 10 3/4"



**MAYO-HEGAR**

- Z-18-153-160 16 cm, 6 1/4"
- Z-18-154-180 18 cm, 7"
- Z-18-155-200 20 cm, 8"
- Z-18-156-210 21 cm, 8 1/2"

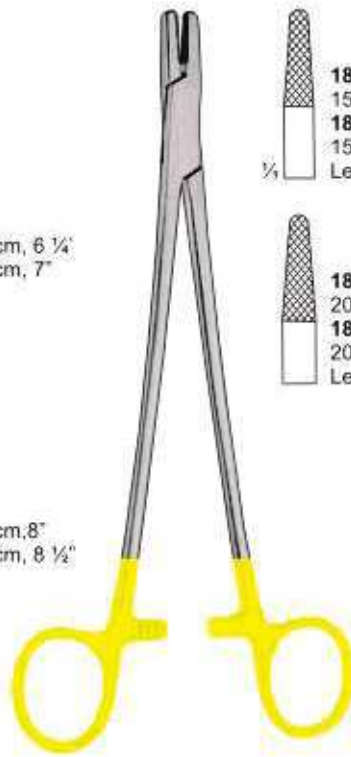

**MAYO-HEGAR**

- 18-157-152 15.2 cm, 6"
- 18-158-152 15.2 cm, 6"
- 18-159-178 17.8 cm, 7"
- 18-160-178 17.8 cm, 7"
- 18-161-203 20.3 cm, 8"
- 18-162-203 20.3 cm, 8"
- 18-163-230 23 cm, 9"
- 18-164-298 29.8 cm, 12"

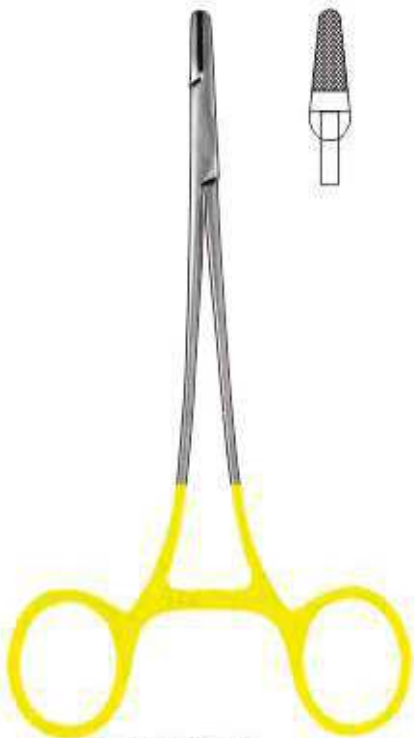

- FINOCHIETTO**
- Z-18-165-130 13 cm, 5 1/4"
- Z-18-166-160 16 cm, 6 1/4"
- Z-18-167-190 19 cm, 7 1/2"
- Z-18-168-210 21 cm, 8 1/4"



- FINOCHIETTO**
- Z-18-169-130 13 cm, 5 1/4"
- Z-18-170-160 16 cm, 6 1/4"
- Z-18-171-190 19 cm, 7 1/2"



**FINOCHIETTO**  
Angled

- Z-18-172-203 20.3 cm, 8"
- Z-18-173-267 26.7 cm, 10 1/2"

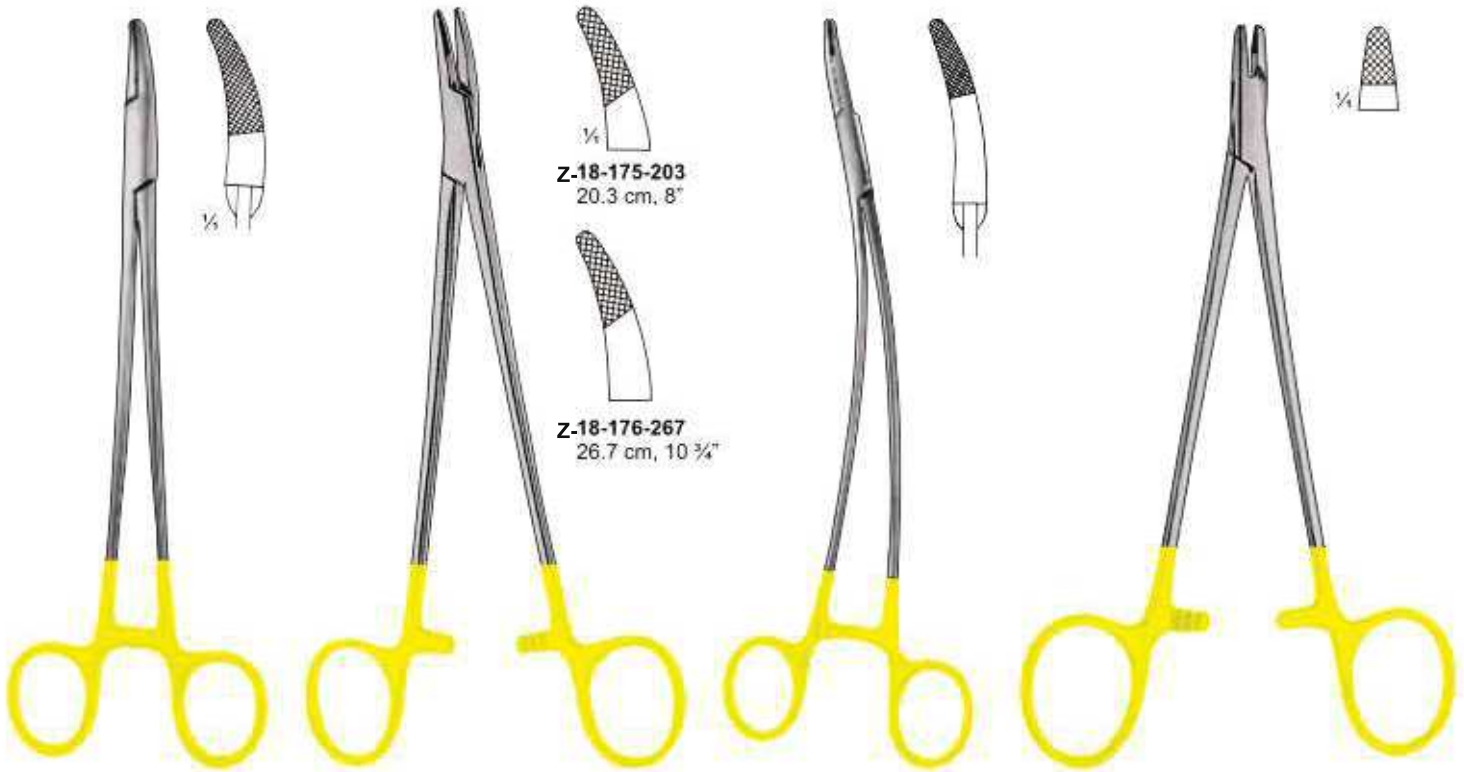

**HEANEY**  
Z-18-174-200  
20 cm, 8"

**HEANEY**  
Cvd.

Z-18-175-203  
20.3 cm, 8"

Z-18-176-267  
26.7 cm, 10 3/4"

**STRATTE**  
Z-18-177-200 20 cm, 8"  
Z-18-178-220 22 cm, 8 3/4"  
Z-18-179-250 25 cm, 10"

**NEW ORLEANS**  
Z-18-180-178  
17.8 cm, 7"



**CRILE-WOOD**

**GILLIES**  
Z-18-183-160  
16 cm, 6 1/4"

**HALSEY**

**OLSEN-HEGAR**

Z-18-181-150  
15 cm, 6"

Z-18-182-150  
15 cm, 6"  
Smooth

Z-18-184-125  
12.5 cm, 5"

Z-18-185-125  
12.5 cm, 5"  
Smooth

Z-18-186-146  
14.6 cm, 5 1/2"

Z-18-187-184  
18.4 cm, 7 1/4"

NEEDLE HOLDERS T.C. INSERTED



Nadelhalter  
Porta-agujas

Porte-agujas  
Portaghi



**RYDER**  
Narrow jaws.



**Z-18-188-127**  
Smooth inserts.  
12.7 cm, 5 1/4"



**Z-18-189-152**  
Smooth inserts.  
15.2 cm, 6"



**Z-18-190-178**  
Smooth inserts.  
17.8 cm, 7"



**Z-18-191-203**  
Smooth inserts.  
20.3 cm, 8"



**Z-18-192-229**  
Smooth inserts.  
22.9 cm, 9"



**Z-18-193-127**  
12.7 cm, 5 1/4"



**Z-18-194-152**  
15.2 cm, 6"



**Z-18-195-178**  
17.8 cm, 7"



**Z-18-196-203**  
20.3 cm, 8"



**Z-18-197-229**  
22.9 cm, 9"



**COOLEY INTRACARDIAC**  
Straight, narrow jaw.



**Z-18-198-178**  
17.8 cm, 7"  
**Z-18-199-203**  
20.3 cm, 8"



**Z-18-200-229**  
22.9 cm, 9"  
**Z-18-201-263**  
26.3 cm, 10 1/2"



**Z-18-202-181**  
18.1 cm, 7"  
**Z-18-203-229**  
22.9 cm, 9"



**Z-18-204-263**  
26.3 cm, 10 1/2"



**Z-18-205-298**  
29.8 cm, 12"

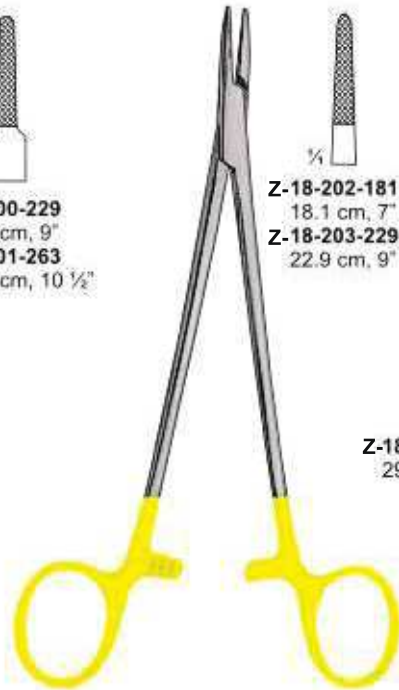





**DEBAKEY CARDIOVASCULAR**  
Delicate patterns. Straight jaw, serrated.







**MICROVASCULAR**  
**Z-18-206-181** 18.1 cm, 7"  
**Z-18-207-203** 20.3 cm, 8"  
**Z-18-208-229** 22.9 cm, 9"  
**Z-18-209-263** 26.3 cm, 10 1/2"  
Straight jaw, serrated.



**RYDER FRENCH-EYE/STANDARD/MICRO**

-   
**Z-18-210-130**  
 13 cm, 5 1/4"  
 Serrated-Solid
-   
**Z-18-211-150**  
 15 cm, 6"  
 Serrated-Solid
-   
**Z-18-212-180**  
 18 cm, 7"  
 Serrated-Solid
-   
**Z-18-213-200**  
 20 cm, 8"  
 Serrated-Solid
-   
**Z-18-214-230**  
 23 cm, 9"  
 Serrated-Solid

-   
**Z-18-215-260**  
 26 cm, 10 1/4"  
 Serrated-Solid
-   
**Z-18-216-130**  
 13 cm, 5 1/4"  
 Serrated-Micro
-   
**Z-18-217-160**  
 16 cm, 6 1/4"  
 Serrated-Micro
-   
**Z-18-218-180**  
 18 cm, 7"  
 Serrated-Micro

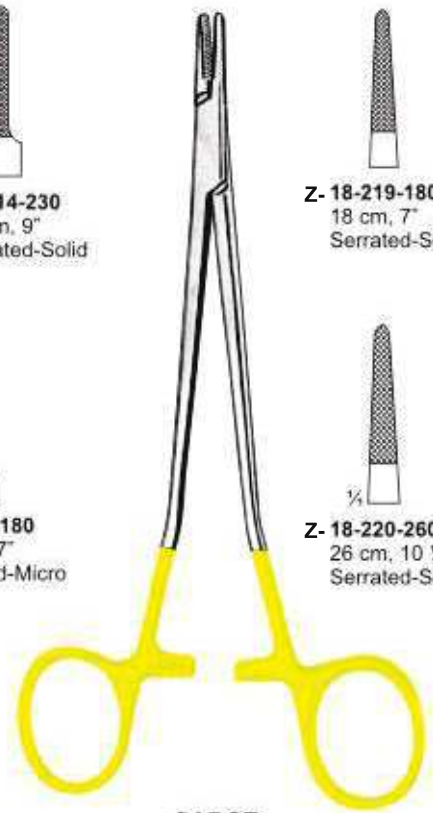

**SAROT**

-   
**Z-18-219-180**  
 18 cm, 7"  
 Serrated-Solid

-   
**Z-18-220-260**  
 26 cm, 10 1/4"  
 Serrated-Solid



**CONVERSE**

-   
**Z-18-221-125**  
 12.5 cm, 5"  
 Tungsten Carbide  
 Serrated-Solid





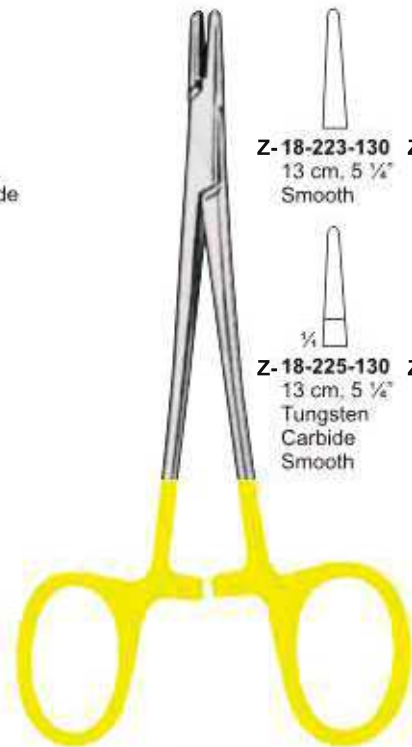

**DERF**

-   
**Z-18-222-125**  
 12.5 cm, 5"  
 Tungsten Carbide  
 Serrated-Solid



**HALSEY**

-   
**Z-18-223-130**  
 13 cm, 5 1/4"  
 Smooth
-   
**Z-18-224-130**  
 13 cm, 5 1/4"  
 Serrated-Solid
-   
**Z-18-225-130**  
 13 cm, 5 1/4"  
 Tungsten Carbide  
 Smooth
-   
**Z-18-226-130**  
 13 cm, 5 1/4"  
 Tungsten Carbide  
 Serrated-Solid

NEEDLE HOLDERS T.C. INSERTED



Nadelhalter  
Porta-agujas

Porte-agujas  
Portaghi

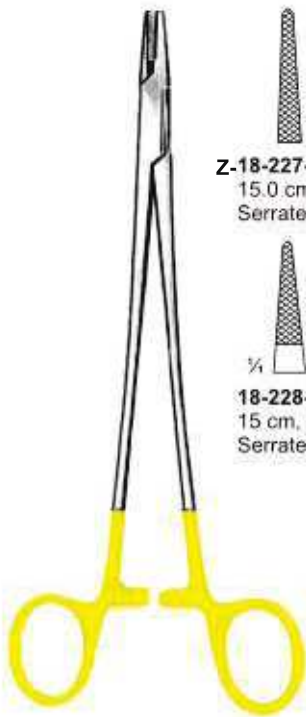

**Z-18-227-155**  
15.0 cm, 6"  
Serrated-Solid



**18-228-150**  
15 cm, 6"  
Serrated-Solid

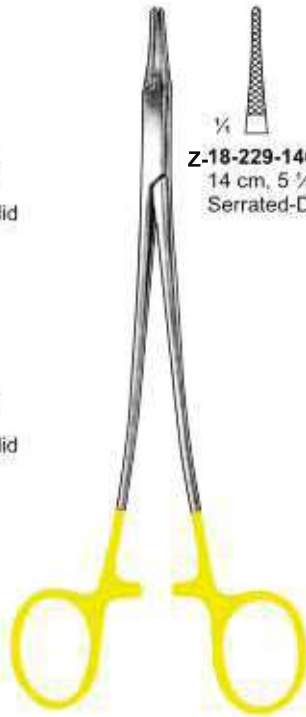

**Z-18-229-140**  
14 cm, 5 1/4"  
Serrated-Delicate

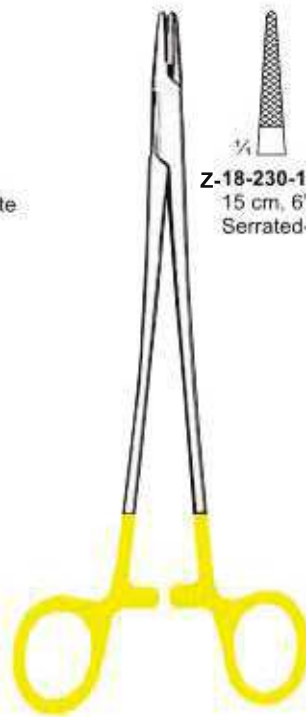

**Z-18-230-150**  
15 cm, 6"  
Serrated-Solid

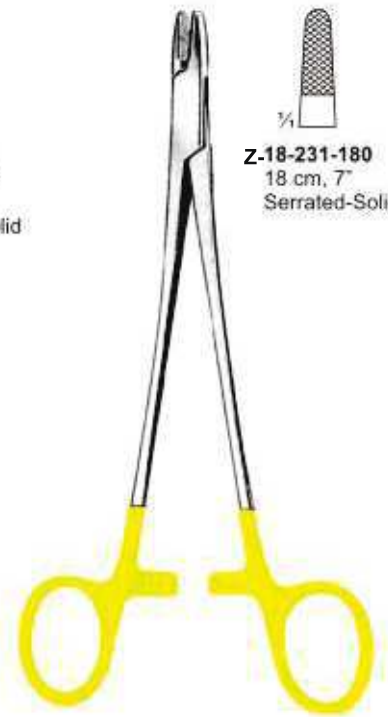

**Z-18-231-180**  
18 cm, 7"  
Serrated-Solid



BABY CRILE-WOOD

EUFRATE PASQUE

CARROLL

NEW ORLEANS



**Z-18-232-140**  
14 cm, 5 1/2"  
Serrated-Solid



**Z-18-233-170**  
17 cm, 6 3/4"  
Serrated-Solid



**Z-18-234-190**  
19 cm, 7 1/2"  
Serrated-Solid



**Z-18-235-140**  
14 cm, 5 1/2"  
Serrated-Solid

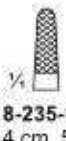

**Z-18-236-170**  
17 cm, 6 3/4"  
Serrated-Solid

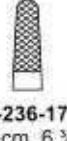

**Z-18-237-190**  
19 cm, 7 1/2"  
Serrated-Solid



OLSEN-HEGAR

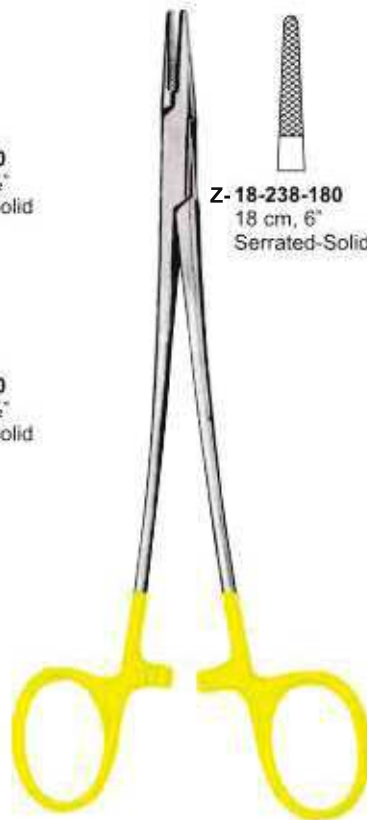

**Z-18-238-180**  
18 cm, 6"  
Serrated-Solid



**Z-18-239-200**  
20 cm, 8"  
Serrated-Solid



**Z-18-240-230**  
23 cm, 9"  
Serrated-Solid



**Z-18-241-260**  
26 cm, 10 1/4"  
Serrated-Solid





**Z-18-242-310**  
31 cm, 12 1/4"  
Serrated-Solid



DEBAKEY-VASCULAR/EXTRA LIGHT

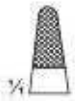

  
**Z-18-243-152**  
15.2 cm, 6"  
Delicate.

  
**Z-18-244-152**  
15.2 cm, 6"  
**Z-18-245-180**  
18 cm, 7"  
**Z-18-246-200**  
20 cm, 8"  
Heavy



  
 $\frac{1}{4}$ "

**WIRE TWISTERS**

**STERNUM**  
**Z-18-247-175**  
17.5 cm, 7"  
Wire Twister



**WIRE TIGHTENING  
PLIERS**  
**Z-18-248-180**  
18 cm, 7"



  
 $\frac{1}{4}$ "

**COOLEY-BAUMGAFTEN  
WIRE TWISTER**  
**Z-18-249-203**  
20.3 cm, 8"  
Extra heavy needle holder designed  
for twisting of wire and placement of  
retention suture. Heavy, blunt jaws.



  
 $\frac{1}{4}$ "

**RUBIO WIRE TWISTER**  
**Z-18-250-127**  
12.7 cm, 5  $\frac{1}{4}$ "

NEEDLE HOLDERS T.C. INSERTED





Nadelhalter  
Porta-agujas

Porte-agujas  
Portaghi



**MICRO DERF**

 **Z-18-251-115**  
 11.5 cm, 4 3/4"  
 **Z-18-252-115**  
 11.5 cm, 4 3/4"  
 Smooth

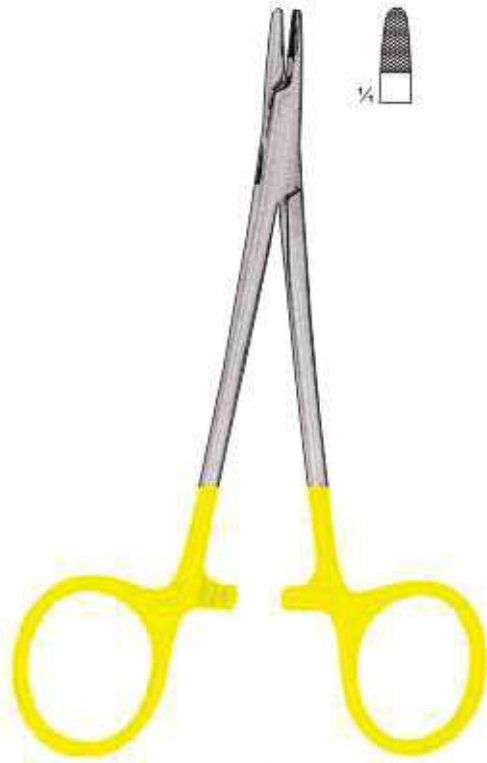

**DERF**  
**Z-18-253-121**  
12.1 cm, 5"

 1/4





**CRILE-WOOD**

  
**Z-18-254-155**  
 15.0 cm, 6"  
 Serrated-Grooved

  
**Z-18-255-190**  
 19 cm, 7 1/2"  
 Serrated-Grooved

  
**Z-18-256-190**  
 19 cm, 7 1/2"  
 Serrated-Grooved

  
**Z-18-257-150**  
 15 cm, 6"  
 Tungsten Carbide  
 Serrated-Slolid

 1/4  
**Z-18-258-180**  
 18 cm, 7"  
 Serrated-Slolid

  
**Z-18-259-200**  
 20 cm, 8"  
 Serrated-Slolid

  
**Z-18-260-230**  
 23 cm, 9"  
 Serrated-Slolid

  
**Z-18-261-155**  
 15.0 cm, 6"  
 Smooth



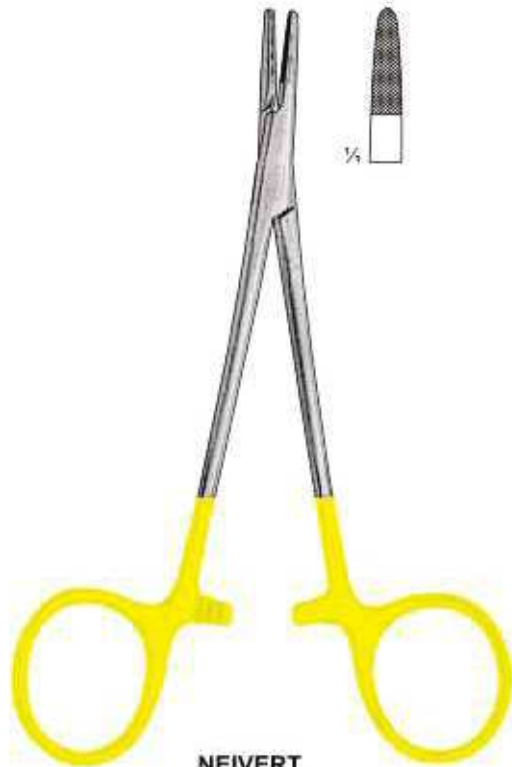

**NEIVERT**  
Z-18-262-127  
12.7 cm, 5 1/4"

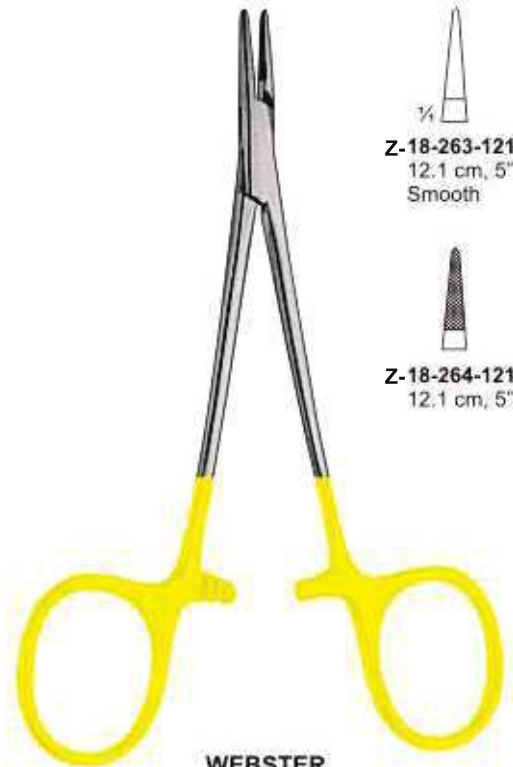

**WEBSTER**

Z-18-263-121  
12.1 cm, 5"  
Smooth

Z-18-264-121  
12.1 cm, 5"



**HEANEY-GYNE**

Z-18-265-210  
21 cm, 8 1/4"  
Serrated-Solid

Z-18-266-210  
21 cm, 8 1/4"  
Tungsten Carbide  
Serrated-Solid

Z-18-267-260  
26 cm, 10 1/4"  
Tungsten Carbide  
Serrated-Solid

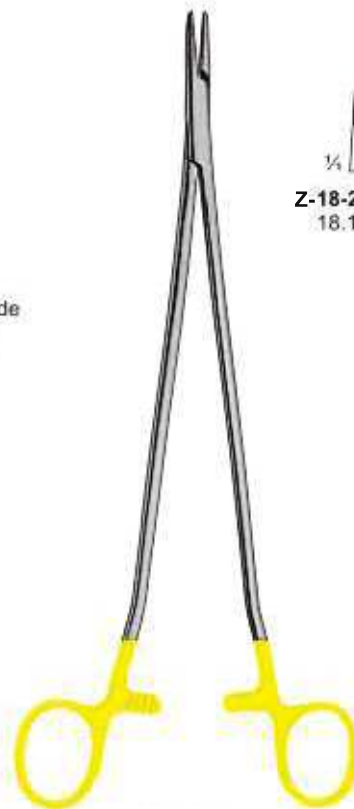

**SAROT**

Z-18-268-181  
18.1 cm, 7"

Z-18-269-263  
26.3 cm, 10 1/2"

NEEDLE HOLDERS T.C. INSERTED









Nadelhalter  
Porta-agujas

Porte-agujas  
Portaghi





COOLEY MICROVASCULAR

- |  |  |  |
|--|--|--|
| <br>Z-18-270-152<br>15.2 cm, 6"<br>Smooth | <br>Z-18-271-171<br>17.1 cm, 6 3/4"<br>Smooth | <br>18-272-203<br>20.3 cm, 8"<br>Smooth |
| <br>Z-18-273-152<br>15.2 cm, 6"           | <br>Z-18-274-171<br>17.1 cm, 6 3/4"           | <br>18-275-203<br>20.3 cm, 8"           |





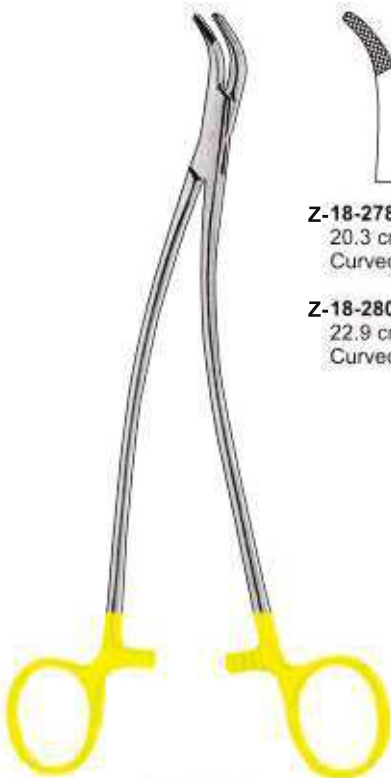

JULIAN

- |  |  |
|--|--|
| <br>Z-18-276-203<br>20.3 cm, 8"<br>Straight | <br>Z-18-277-203<br>20.3 cm, 8"<br>Curved |
|--|--|



STRATTE

- |  |  |
|--|--|
| <br>Z-18-278-203<br>20.3 cm, 8"<br>Curved | <br>Z-18-279-229<br>22.9 cm, 9"<br>Curved |
| <br>Z-18-280-229<br>22.9 cm, 9"<br>Curved | <br>Z-18-281-229<br>22.9 cm, 9"<br>Curved |



ROCHESTER  
Z-18-282-181  
18.1 cm, 7"



**MASSON**  
Z-18-283-263  
26.3 cm, 10 1/2"

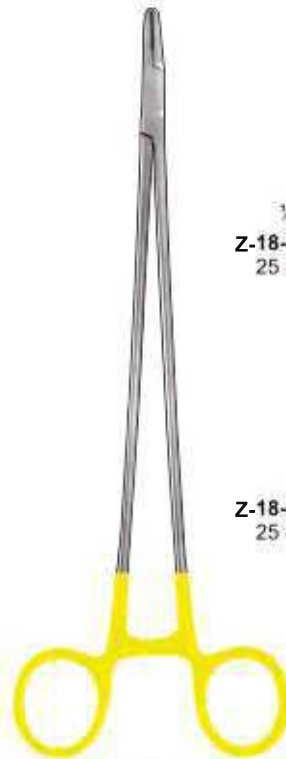

Z-18-284-250  
25 cm, 10"

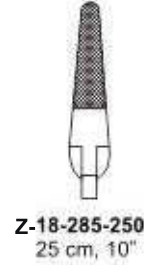

Z-18-285-250  
25 cm, 10"

**MASSON**

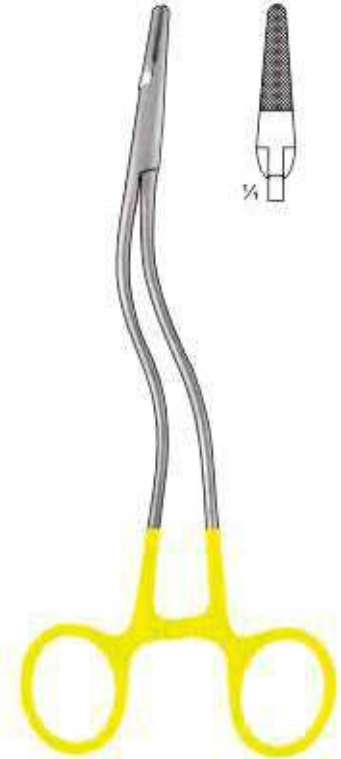

**MASSON-LUTTI-BOZEMAN**  
Z-18-286-200 20 cm, 8"  
Z-18-287-250 25 cm, 10"



**MICROSURGICAL**

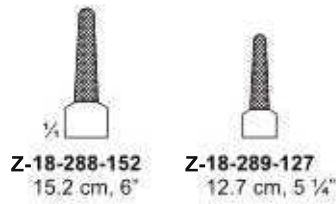

Z-18-288-152  
15.2 cm, 6"



Z-18-289-127  
12.7 cm, 5 1/4"



Z-18-290-127  
12.7 cm, 5 1/4"  
Smooth



**O'BRIEN**  
Z-18-291-300  
30 cm, 12"



**THOMSON-WALKER**  
Z-18-292-200 20 cm, 8"  
Z-18-293-250 25 cm, 10"

NEEDLE HOLDERS T.C. INSERTED



Nadelhalter  
Porta-agujas

Porte-agujas  
Portaghi

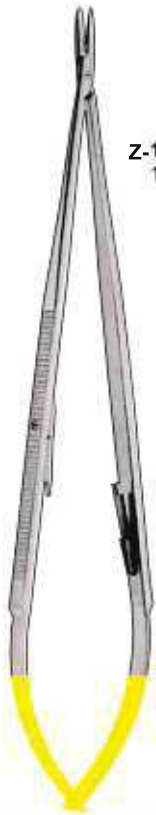

**Z-18-294-184**  
18.4 cm, 7 1/4"  
**Z-18-295-222**  
22.2 cm, 8 3/4"

CASTROVIEJO



**Z-18-296-203**  
20.3 cm, 8"  
Straight  
**Z-18-297-203**  
20.3 cm, 8"  
Curved

MILLS VASCULAR



**Z-18-298-140**  
14 cm, 5 1/2"  
Curved  
**Z-18-299-140**  
14 cm, 5 1/2"  
Straight

CASTROVIEJO

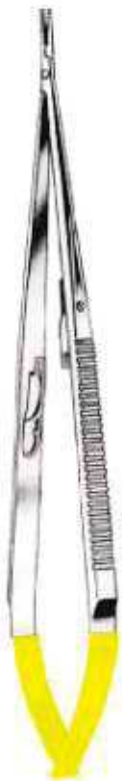

**Z-18-300-180**  
18 cm, 7"  
Smooth  
**Z-18-302-210**  
21 cm, 8 1/4"  
Smooth

JACOBSON





**Z-18-301-210**  
21 cm, 8 1/4"  
Smooth  
**Z-18-303-210**  
21 cm, 8 1/4"  
Serrated-Solid



CASTROVIEJO

**Z-18-304-140**  
14 cm, 5 1/2"  
Straight  
Smooth  
**Z-18-305-140**  
14 cm, 5 1/2"  
Straight  
Serrated-Solid  
**Z-18-306-140**  
14 cm, 5 1/2"  
Curved  
Smooth  
**Z-18-307-140**  
14 cm, 5 1/2"  
Straight  
Smooth  
**Z-18-308-140**  
14 cm, 5 1/2"  
Straight  
Serrated-Solid  
**Z-18-309-140**  
14 cm, 5 1/2"  
Curved  
Serrated-Solid  
**Z-18-310-180**  
18 cm, 7"  
Straight  
Serrated-Solid



-  **Z-18-311-143**  
14.3 cm, 5 1/2"  
Curved
-  **Z-18-312-146**  
14.6 cm, 5 3/4"  
Straight
-  **Z-18-313-146**  
14.6 cm, 5 3/4"  
Straight
-  **Z-18-314-184**  
18.4 cm, 7 1/4"  
Straight

**MICROSURGERY**

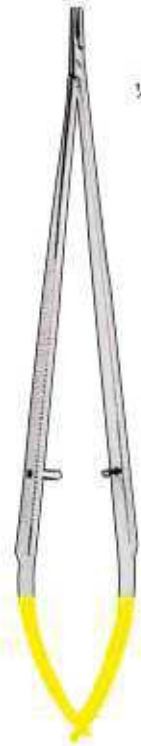

**JACOBSON**  
Z-18-315-222  
22.2 cm, 8 3/4"



**TOENNIS**  
Z-18-316-185  
18.5 cm, 7"



**BOYNTON**  
Z-18-317-120  
12 cm, 5"



**ARRUGA**  
Z-18-318-160 16 cm, 6 1/4" Str.  
Z-18-319-160 16 cm, 6 1/4" Cvd.



**SPENCER CORONARY**  
Z-18-320-178  
17.8 cm, 7"



**METZENBAUM**  
Z-18-321-190  
19 cm, 7 1/2"



**MATHIEU-STILLE**

-  **Z-18-322-170**  
17 cm, 6 3/4"
-  **Z-18-323-200**  
20 cm, 8"

Nadelhalter  
Porta-agujas

Porte-agujas  
Portaghi



**Z-18-324-170**  
17 cm, 6 3/4"



**Z-18-325-170**  
17 cm, 6 3/4"  
Smooth

**CASTROVIEJO**



**JACOBSON HEAVY STYLE**

**Z-18-326-190** 19.0 cm, 7 1/2"  
**Z-18-327-229** 22.9 cm, 9"  
**Z-18-328-254** 25.4 cm, 10"



**Z-18-329-135**  
13.5 cm, 5 1/4"



**Z-18-330-135**  
13.5 cm, 5 1/4"  
Smooth

**CASTROVIEJO**



**KALT**  
**Z-18-331-140**  
14 cm, 5 1/2" Str.



**KALT**  
**Z-18-332-140**  
14 cm, 5 1/2" Str.



**JACOBSON**  
**Z-18-333-185** 18.5 cm, 7 1/4"  
**Z-18-334-210** 21.0 cm, 8 1/4"



**MATHIEU-RYDER**

Z-18-335-170  
17 cm, 6 3/4"



Z-18-336-200  
20 cm, 8"



Z-18-337-240  
24 cm, 9 1/2"

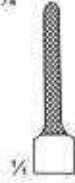

**MATHIEU-RYDER  
VASCULAR**

Z-18-338-170  
17 cm, 6 3/4"



Z-18-339-200  
20 cm, 8"



Z-18-340-240  
24 cm, 9 1/2"

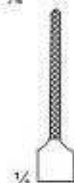

**CORWIN**

Z-18-341-150  
15 cm, 6"



Z-18-342-150  
15 cm, 6"



Z-18-343-165  
16.5 cm, 6 1/2"



**LICHTENBERG**  
Z-18-344-140  
20 cm, 8"



NEEDLE HOLDERS T.C. INSERTED



Nadelhalter  
Porta-agujas

Porte-agujas  
Portaghi



LANGENBECK



Z-18-345-160  
16.0 cm, 6 1/4"



Z-18-346-180  
18.0 cm, 7"



Z-18-347-200  
20.0 cm, 8"

LANGENBECK-DELICATE



Z-18-348-180  
18.0 cm, 7"



Z-18-349-200  
20.0 cm, 8"



Z-18-350-230  
23.0 cm, 9"

LANGENBECK-RYDER



Z-18-351-180  
18.0 cm, 7"



Z-18-352-200  
20.0 cm, 8"



Z-18-353-230  
23.0 cm, 9"



ZWEIFEL



Z-18-354-200  
20 cm, 8"



Z-18-355-230  
23 cm, 9"



EISELSBERG-MATHEIU  
Z-18-356-185  
18.5 cm, 7 1/4"



LUETHY-BECK  
Z-18-357-200  
20.0 cm, 8"







**REVERDIN**  
short



**Z-18-358-145**  
14.5cm, 5 3/4"



**Z-18-359-145**  
14.5cm, 5 3/4"



**Z-18-360-145**  
14.5cm, 5 3/4"



**Z-18-361-145**  
14.5cm, 5 3/4"



**REVERDIN NEEDLE**  
Z-18-362-195 -  
Z-18-365-195  
Small



**Z-18-362-195**  
19.5cm, 7 3/4"  
Z-18-362-230  
23cm, 9"



**Z-18-363-195**  
19.5cm, 7 3/4"  
Z-18-363-230  
23cm, 9"



**Z-18-364-195**  
19.5cm, 7 3/4"  
Z-18-364-230  
23cm, 9"



**Z-18-365-195**  
19.5cm, 7 3/4"  
Z-18-365-230  
23cm, 9"



**REVERDIN**  
Z-18-362-230 -  
Z-18-365-230  
long

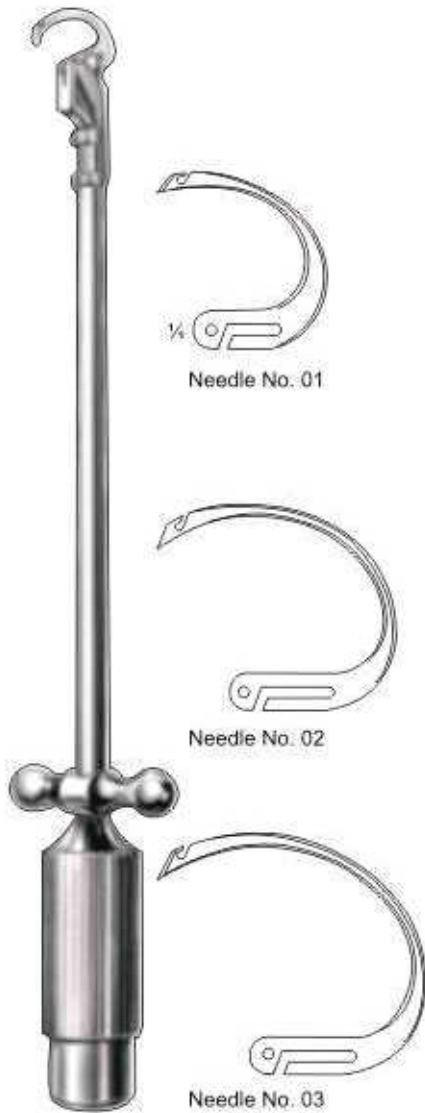

**YOUNG**  
Z-18-366-245  
24.5 cm, 10"  
Complete  
with on  
Needle no. 01

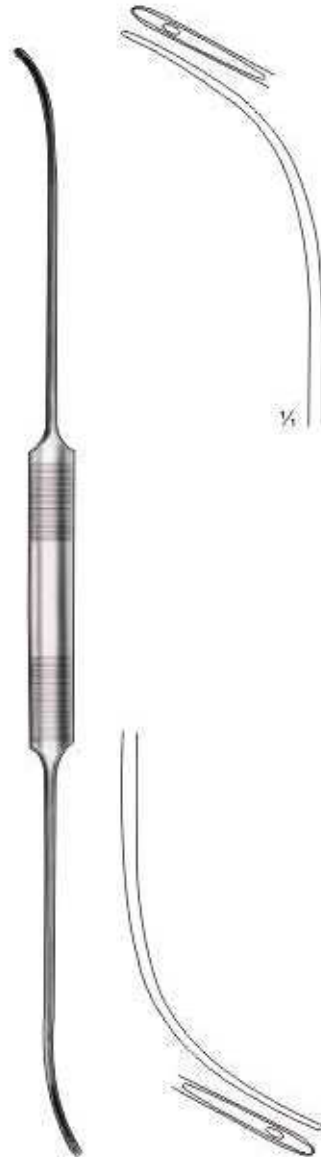

**SCHMIEDEN-DICK**  
Z-18-367-290  
29cm, 11 1/2"  
malleable



**SCHMIEDEN**  
Z-18-368-240  
24cm, 9 1/2"



**LIGATURE NEEDLE**  
Z-18-369-200  
20cm, 8"

**COOPER**  
Z-18-370-190  
19 cm, 7 ½"

**KRONECKER**  
Z-18-371-130  
13 cm, 5 ¼"  
delicate  
for right hand

**KRONECKER**  
Z-18-372-130  
13 cm, 5 ¼"  
delicate  
for left hand

Curved to left,  
for the right  
hand

Curved to left,  
for the left  
hand

**DESCHAMPS**  
Z-18-373-240  
24 cm, 9 ½"

**DESCHAMPS**  
Z-18-374-240  
24 cm, 9 ½"

Unterbindungsnadeln  
agujas para ligaduras

Aiguilles à ligatures  
aghi di legatura



**DESCHAMPS**  
Z-18-375-200 20cm, 8"  
sharp for right hand  
Z-18-376-200 20cm, 8"  
sharp for left hand



**DESCHAMPS**  
Z-18-377-200 20cm, 8"  
blunt for right hand  
Z-18-378-200 20cm, 8"  
blunt for left hand



**DESCHAMPS**  
Z-18-379-210 21cm, 8 1/4"  
blunt for right hand  
Z-18-380-210 21cm, 8 1/4"  
blunt for left hand

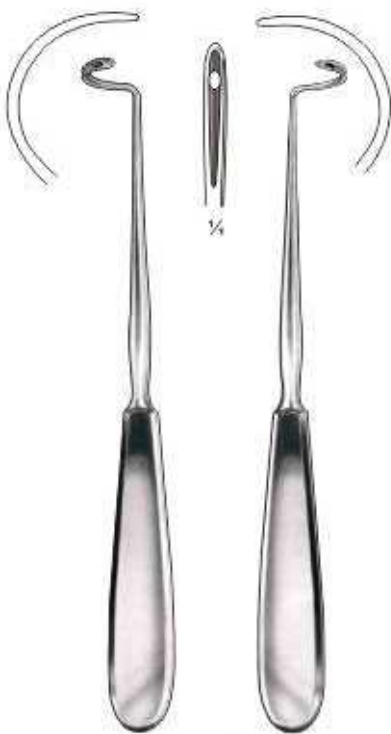

**Deschamps**  
Z-18-381-200 20cm  
blunt for right hand  
Z-18-382-200 20cm  
blunt for left hand



**Deschamps**  
Z-18-383-200 20cm  
sharp for right hand  
Z-18-384-200 20cm  
sharp for left hand



**Deschamps**  
Z-18-385-200 20cm  
blunt for right hand  
Z-18-386-200 20cm  
blunt for left hand



**DESCHAMPS**

**Z-18-387-200**   **Z-18-388-200**  
20cm, 8"   20cm, 8"  
sharp   sharp  
for right   for left  
hand   hand

**DESCHAMPS**

**Z-18-389-270**   **Z-18-390-270**  
27cm, 10 3/4"   27cm, 10 3/4"  
blunt   blunt  
for right   for left  
hand   hand

**DESCHAMPS**

**Z-18-391-270**   **Z-18-392-270**  
27cm, 10 3/4"   27cm, 10 3/4"  
sharp   sharp  
for right   for left  
hand   hand

**DESCHAMPS**

**Z-18-393-280**   **Z-18-394-280**  
28cm, 11"   28cm, 11"  
blunt   blunt  
for right   for left  
hand   hand

Allgemeines Instrumentarium  
 Instrumental general

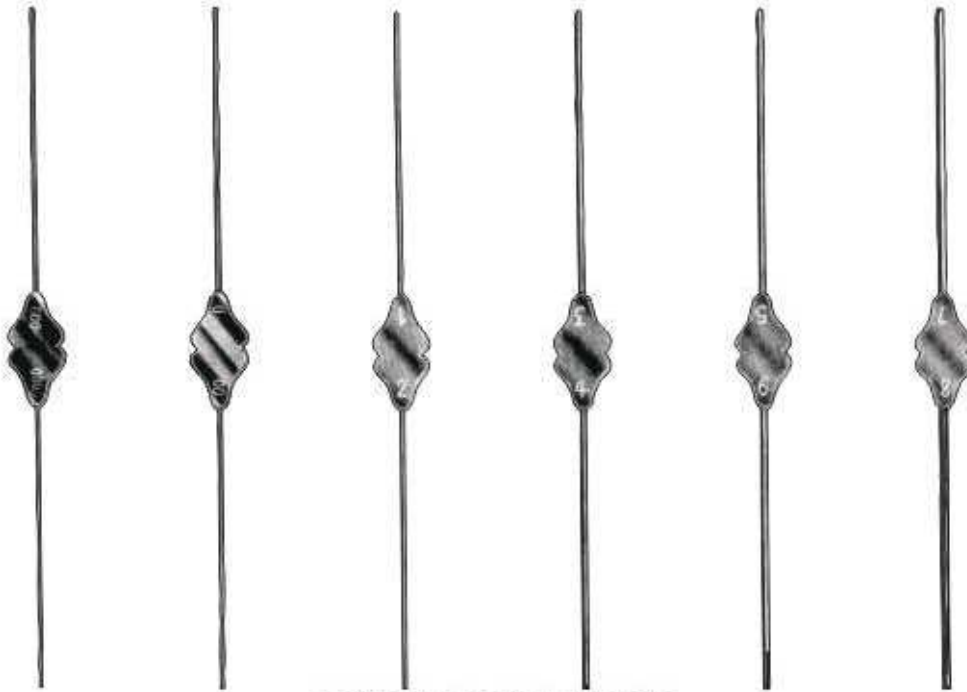

**BOWMAN LACRIMAL PROBES**  
 Double Ended, Sterling Silver

- |  |  |   |   |   |   |
|--|--|---|---|---|---|
| <b>Z-18-395-001</b><br>Bowman Probe,<br>000-0000 | <b>Z-18-396-002</b><br>Bowman Probe,<br>00-0 | <b>Z-18-397-003</b><br>Bowman Probe,<br>1-2 | <b>Z-18-398-004</b><br>Bowman Probe,<br>3-4 | <b>Z-18-399-005</b><br>Bowman Probe,<br>5-6 | <b>Z-18-400-006</b><br>Bowman Probe,<br>7-8 |
|--|--|---|---|---|---|

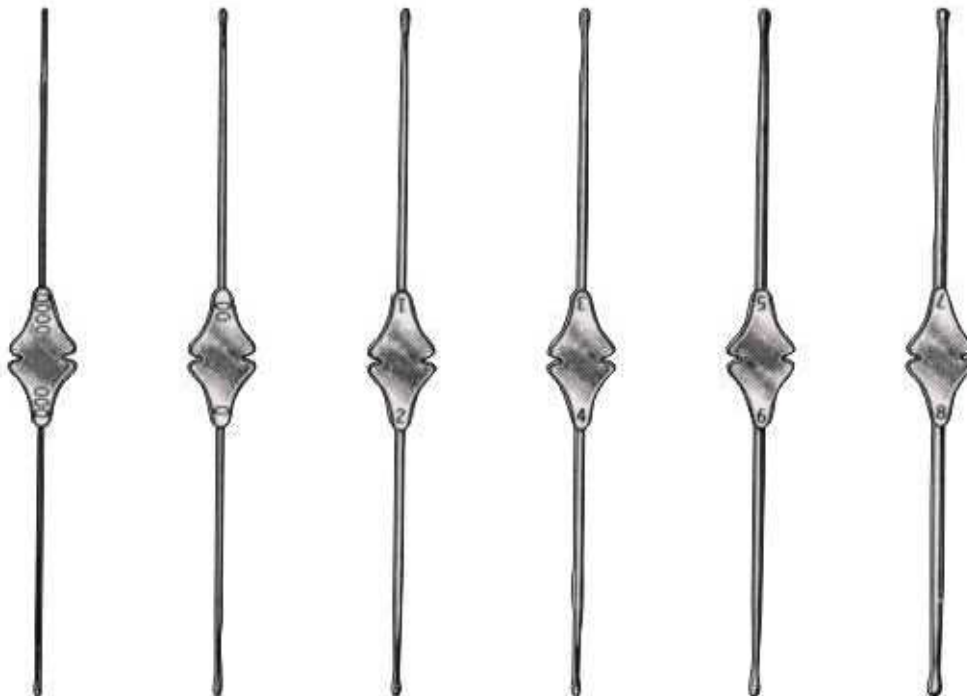

**WILLIAM LACRIMAL PROBES**  
 Double Ended, Sterling Silver

- |   |   |  |  |  |  |
|---|---|--|--|--|--|
| <b>Z-18-401-001</b><br>William Probe,<br>000-0000 | <b>Z-18-402-002</b><br>William Probe,<br>00-0 | <b>Z-18-403-003</b><br>William Probe,<br>1-2 | <b>Z-18-404-004</b><br>William Probe,<br>3-4 | <b>Z-18-405-005</b><br>William Probe,<br>5-6 | <b>Z-18-406-006</b><br>William Probe,<br>7-8 |
|---|---|--|--|--|--|



**DIRECTORS**

- Z-18-407-130 13 cm, 5"
- Z-18-408-145 14.5 cm, 5 3/4"
- Z-18-409-116 16 cm, 6"

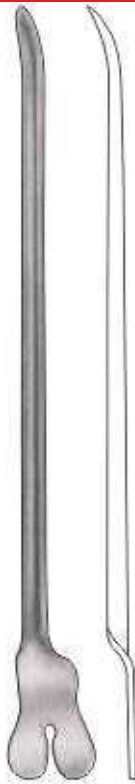

**DOYEN**

- Z-18-410-145 14.5 cm, 5 3/4"



**NELATON**

- Z-18-411-160 16 cm, 6"



**Z-18-412-140**

- 14 cm, 5 1/2"
- Director with tip
- Diam. Of tip 3.3 mm

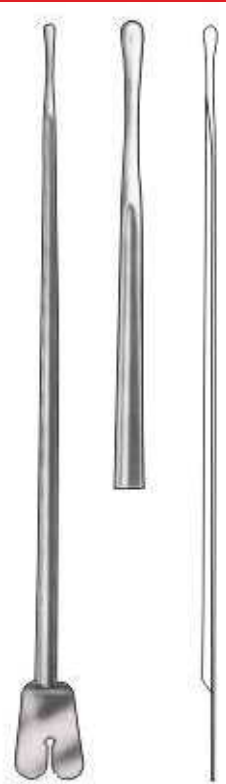

**BRODIE**

- Z-18-413-200 20 cm, 8"
- Director with tip
- Diam. Of tip 3.5 mm

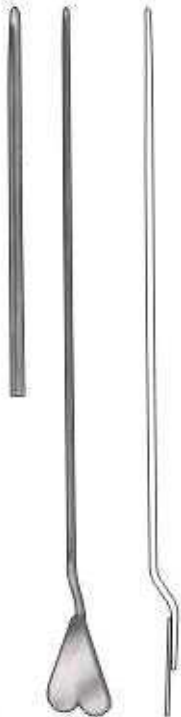

**LOCKHART-MUMMERY**

- Z-18-414-165 16.5 cm, 6 1/2"



**LOCKHART-MUMMERY**

- Z-18-415-165 16.5 cm, 6 1/2"

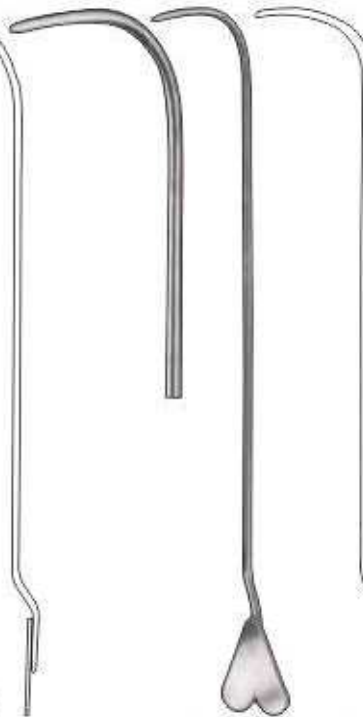

**LOCKHART-MUMMERY**

- Z-18-416-165 16.5 cm, 6 1/2"

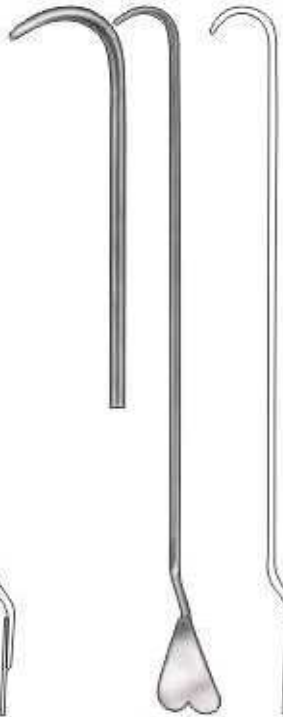

**LOCKHART-MUMMERY**

- Z-18-417-165 16.5 cm, 6 1/2"



**Z-18-418-190**

- 19 cm, 7 1/2"
- director with wire loop, malleable

Allgemeines Instrumentarium  
 Instrumental general



**Z-18-419-145** 14.5 cm, 5 3/4"  
**Z-18-420-160** 16.0 cm, 6 1/4"  
**Z-18-421-200** 20.0 cm, 8"  
 probes with eye



**Z-18-422-145**  
 14.5 cm, 5 3/4"  
 Myrtle leaf probe



**Z-18-423-130** 13.0 cm, 5"  
**Z-18-424-145** 14.5 cm, 5 3/4"  
**Z-18-425-160** 16.0 cm, 6 1/4"  
**Z-18-426-185** 18.5 cm, 7"  
**Z-18-427-200** 20.0 cm, 8"



**Z-18-428-001**  
 probe



**Z-18-429-190**  
 19.0 cm, 8 1/4"  
 Double ended probe,  
 malleable, diam. of tips  
 3 mm with hole



**Z-18-430-250** 25.0 cm, 10"  
**Z-18-431-300** 30.0 cm, 12"  
 Double ended probes,  
 tin, malleable, diam. of tips  
 3.5 mm with hole



**Z-18-432-400**  
 40.0 cm, 15 3/4"  
 Double ended probes,  
 tin, malleable, diam. of tips  
 4 mm with hole



**Z-18-433-300** 1.5 mm  
**Z-18-434-300** 2.0 mm  
**Z-18-435-300** 2.5 mm  
 30.0 cm, 12"





**STACKE**  
Z-18-436-100  
10.0 cm, 4"



**KILLIAN**  
Z-18-437-165  
16.5 cm, 6 1/2"



**Z-18-438-165**  
16.5 cm, 6 1/2"



**SEIFFERT**  
Z-18-439-180  
18.0 cm, 7"



**SPATULA**  
Z-18-440-145  
14.5 cm, 5 3/4"



**SPATULA**  
Z-18-441-145  
14.5 cm, 5 3/4"



**MODELL PICCOLO**  
Z-18-442-110  
11.0 cm, 4 1/4"  
Round Serrated



**MODELL PICCOLO**  
Z-18-443-110  
11.0 cm, 4 1/4"  
Triangular Serrated end



**FARRELL**  
Z-18-444-110  
11.0 cm, 4 1/4"  
Round Serrated end



**LATHBURY-FARREL**  
Z-18-445-110  
11.0 cm, 4 1/4"  
Triangular Serrated end

Allgemeines Instrumentarium  
 Instrumental general

Instrumentation générale  
 Strumentario generale



3/4  
 1.2 mm Ø

**BUCK** **MARTIN** **Z-18-450-140** **Z-18-451-140** **Z-18-452-140** **Z-18-453-140** **FARRELL** **LATHBURY-FARRELL**  
**Z-18-446-120** **Z-18-447-120** 14.0 cm, 5 1/4" 14.0 cm, 5 1/4" 14.0 cm, 5 1/4" 14.0 cm, 5 1/4" **Z-18-454-140** **Z-18-455-140**  
 12.0 cm, 4 1/4" 12 cm, 5" Triangular serrated end rough, spiral end rough, spiral end rough, spiral end 14.0 cm, 5 1/4" 14.0 cm, 5 1/4"  
 rough, spiral end **18-448-140** 14 cm, 5 1/2" Round, serrated end Triangular serrated end  
**18-449-160** 16 cm, 6 1/4"



**FARRELL** **LATHBURY-FARRELL** **Z-18-458-160** **Z-18-459-180** **Z-18-460-180** **VOLLMAR** **Z-18-462-270**  
**Z-18-456-160** **Z-18-457-160** 16.0 cm, 6 1/4" 18.0 cm, 7" 18.0 cm, 7" **Z-18-461-115** 27.0 cm, 10 3/4"  
 16.0 cm, 6 1/4" Triangular serrated end Triangular serrated end Rough spiral end Rough spiral end 11.5 cm, 4 1/2" Rough spiral end  
 Rough spiral end



**OCHSNER**  
Z-18-463-140  
14 cm, 5 1/2"



**LANGE**  
Z-18-464-100  
10 cm, 4"



**CHILDE**  
Z-18-465-180  
18 cm, 7"



**MICHEL**  
Z-18-466-120  
12 cm, 4 3/4"



**WACHENFELDT**  
Z-18-467-125  
12.5 cm, 5"



**HEGENBARTH**  
Z-18-468-125  
12.5 cm, 5"



**WACHENFELDT**  
Z-18-469-125  
12.5 cm, 5"



**MICHEL**  
Z-18-470-120  
12 cm, 4 3/4"



**MOD. MICHEL**  
Z-18-471-120  
12 cm, 4 3/4"



**COLLIN**  
Z-18-472-130  
13 cm, 5"



**RICHTER-HEATH**  
Z-18-473-140  
14 cm, 5 1/2"

Allgemeines Instrumentarium  
 Instrumental general

Instrumentation générale  
 Strumentario generale



**CUTICLE NIPPER**  
 Z-18-474-110  
 11 cm, 4 1/2"



**NAIL NIPPER**

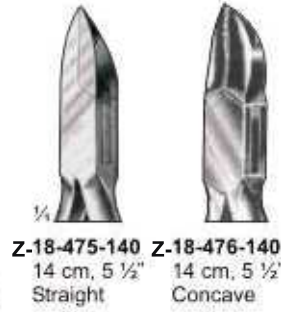

Z-18-475-140 14 cm, 5 1/2" Straight  
 Z-18-476-140 14 cm, 5 1/2" Concave



**NAIL CLIPPER**  
 Z-18-477-140  
 14 cm, 5 1/2" Angled / Concave



**NAIL NIPPER**  
 Z-18-478-130  
 13 cm, 5 1/4" Straight



**NAIL NIPPER**  
 Z-18-479-105  
 10.5 cm, 4"



**NAIL NIPPER**  
 Z-18-481-152  
 15.0 cm, 6" Barrel Spring Concave



**NAIL NIPPER**  
 Z-18-482-130  
 13 cm, 5 1/4" Barrel Spring Concave

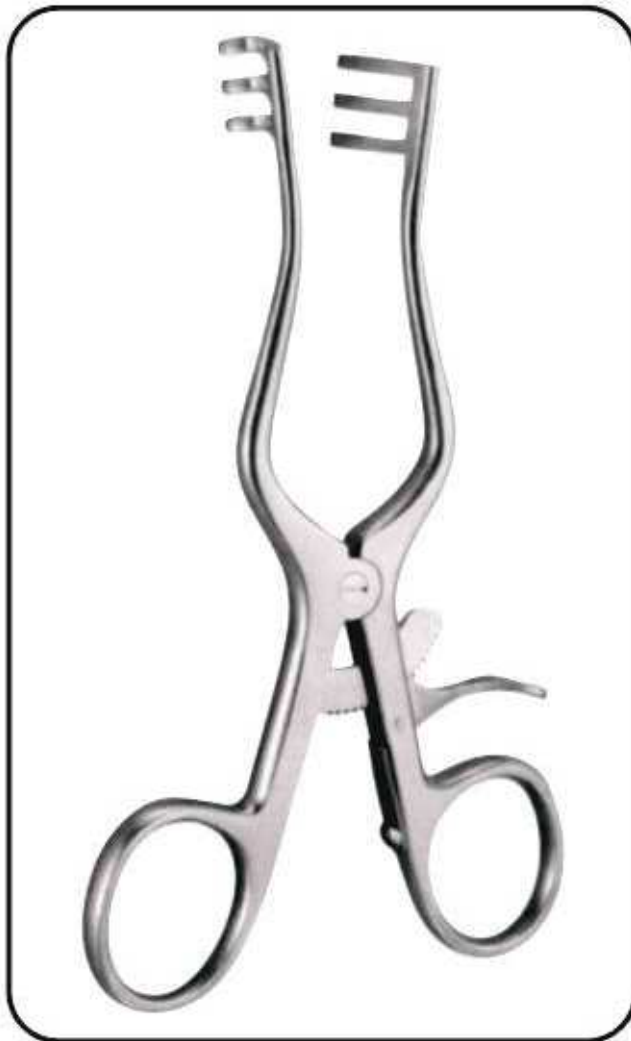

Wundhäkchen, Mikrohäkchen  
 Ganchito, Micro Ganchitos

Crochet, Micro crochetes  
 Divaricatore, Micro Divaricatori



**Z-19-001-160**  
 16 cm, 6 1/4"  
 large curve

**Z-19-002-160**  
 16 cm, 6 1/4"  
 small curve

**GUTHRIE**



**Z-19-003-180**  
 18 cm, 7"  
 Sharp

**Z-19-004-180**  
 18 cm, 7"  
 sharp

**GILLIES**



**Z-19-005-150**  
 15 cm, 6"  
 blunt

**KILNER**



**Z-19-006-185**  
 18.5 cm, 7 1/4"  
 sharp

**Z-19-007-185**  
 18.5 cm, 7 1/4"  
 sharp

**FISCH**



**Z-19-008-130**  
 13 cm, 5"  
**Z-19-009-180**  
 18 cm, 7"  
 Blunt

**Z-19-010-130**  
 13 cm, 5"  
**Z-19-011-180**  
 18 cm, 7"  
 Sharp

**FRAZIER**



**DOUBLE PRONG  
 MICRO HOOK**  
**Z-19-012-145**  
 Sharp, 2mm, wide jaws,  
 14.5 cm, 6 1/4"



**WIENER HOOK**  
**Z-19-013-140**  
 Sharp,  
 14 cm, 5 1/2"



**TOENNIS**  
**Z-19-014-150**  
 15 cm, 6"  
 Sharp



**Z-19-015-130**  
 2 x sharp  
 13 cm, 5"

**Z-19-016-130**  
 4 x sharp  
 13 cm, 5"

**Z-19-017-130**  
 4 x blunt  
 13 cm, 5"

**ROLLET**



**Z-19-018-150**  
 sharp  
 15 cm, 6"

**FREER**



**Z-19-020-165**  
sharp  
2.0 mm

**Z-19-021-165**  
Sharp  
5.0 mm

**Z-19-022-165**  
Sharp  
7.0 mm

**JOSEPH**  
Z-19-019-165  
16.5 cm, 6 1/2"



**COTLE**  
Z-19-023-160  
16 cm, 6 1/4"  
Sharp



**Z-19-024-150**  
15 cm, 6"  
sharp

**Z-19-025-150**  
15 cm, 6"  
sharp

**Z-19-026-150**  
15 cm, 6"  
sharp

**COTLE**



**NIRO**  
Z-19-027-170  
17 cm, 6 3/4"



**NIRO**  
Z-19-028-170  
17 cm, 6 3/4"



**NIRO**  
Z-19-029-170  
17 cm, 6 3/4"



**NIRO**  
Z-19-030-170  
17 cm, 6 3/4"



**ALLPORT**  
Z-19-031-160  
16 cm, 6 1/2"



**YANKAUER**  
Z-19-032-150  
15 cm, 6"



**SACHS**  
Z-19-033-210  
21 cm, 8 1/4"



$\frac{3}{4}$  Z-19-035-185  $\frac{3}{4}$  Z-19-036-185  $\frac{3}{4}$  Z-19-037-185  $\frac{3}{4}$  Z-19-038-185

**KRAYENBUHL**  
Z-19-034-185  
18.5cm 7"



$\frac{3}{4}$  Z-19-040-245  $\frac{3}{4}$  Z-19-041-245  $\frac{3}{4}$  Z-19-042-245  $\frac{3}{4}$  Z-19-043-245

**CASPAR**  
Z-19-039-245  
24.5cm 9.5"





**CRILE**  
Z-19-044-200 20 cm, 8"



**GRAEFE**  
Z-19-045-130 13.0 cm, 5" - A  
Z-19-046-140 14.0 cm, 5 1/2" - B  
Z-19-047-150 15.0 cm, 6" - C



**WAGENER**  
Z-19-048-140 14 cm, 5 1/2" - A  
Z-19-049-140 14 cm, 5 1/2" - B  
Z-19-050-140 14 cm, 5 1/2" - C  
Z-19-051-140 14 cm, 5 1/2" - D



**DAY**  
Z-19-052-160 16 cm, 6 1/4" - A  
Z-19-053-160 16 cm, 6 1/4" - B



**LUCAE**  
Z-19-054-140 14 cm, 5 1/2" - A  
Z-19-055-140 14 cm, 5 1/2" - B  
Z-19-056-140 14 cm, 5 1/2" - C



**MANNERFELT-LANGENBECK**  
Z-19-057-155 15 x 6 mm 15.5 cm, 6" Fig.1  
Z-19-058-155 20 x 6 mm 15.5 cm, 6" Fig.2  
Z-19-059-155 25 x 6 mm 15.5 cm, 6" Fig.3  
Z-19-060-155 30 x 8 mm 15.5 cm, 6" Fig.4

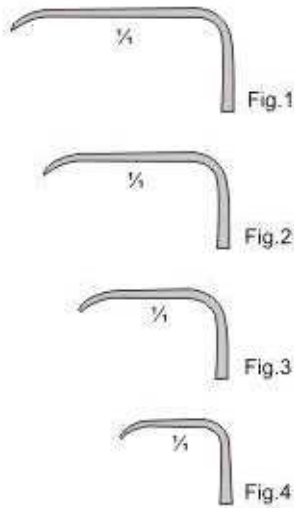

**MANNERFELT**  
15.5 cm, 6"  
large curve, blunt



19-061-155  
Sharp



19-062-155  
Blunt



19-063-155  
Blunt

Wundhäkchen, Mikrohäkchen  
Ganchito, Micro Ganchitos

Crochet, Micro crochetes  
Divaricatore, Micro Divaricatori



**ITERSON**  
Z-19-064-160  
16 cm, 6 1/4"



**ITERSON**  
Z-19-065-160  
16 cm, 6 1/4"



**BOSE**  
Z-19-066-160  
16 cm, 6 1/4"



**BOSE**  
Z-19-067-160  
16 cm, 6 1/4"



**BOSE**  
Z-19-068-160  
16 cm, 6 1/4"



**BOSE**  
Z-19-069-160  
16 cm, 6 1/4"



**LANGE**  
Z-19-070-220  
22 cm, 8 3/4"  
Fistula hook



**KILNER**  
Z-19-071-100  
10 cm, 4"  
sharp  
Skin hooks



**EMMET**  
Z-19-072-220  
22 cm, 8 3/4"  
Fistula hook



**SIMON**  
Z-19-073-220  
22 cm, 8 3/4"  
1 x sharp  
Fistula Hook



**SIMON**  
Z-19-074-220  
22 cm, 8 3/4"  
2 x sharp



**HARTMANN**  
Z-19-075-160  
16 cm, 6 1/4"  
sharp



**GRAEFE**



**Z-19-076-160**  
16 cm, 6 1/4"  
blunt



**Z-19-077-160**  
16 cm, 6 1/4"  
sharp



**FOMON**  
**Z-19-078-170**  
17 cm, 6 3/4"  
blunt



**CUSHING**  
**Z-19-079-190**  
19 cm, 7 1/2" blunt  
**Z-19-080-190**  
19 cm, 7 1/2" sharp  
Nerve-and  
vessel hook



**CUSHING**  
**Z-19-081-280**  
28 cm, 11" blunt  
**Z-19-082-280**  
28 cm, 11" sharp  
Nerve-and  
vessel hook



**CUSHING**  
**Z-19-083-190**  
19 cm, 7 1/2"



**FOMON**  
**Z-19-084-160**  
16 cm, 6 1/4"  
blunt  
Choana hook



**COTTLE-NEIVERT**  
**Z-19-085-200**  
20 cm, 8"  
blunt



**COTTLE**  
**Z-19-086-150**  
15 cm, 6"  
Sharp



**COTTLE**  
**Z-19-087-150**  
15 cm, 6"  
blunt/Sharp



**COTTLE**  
**Z-19-088-150**  
15 cm, 6"  
sharp/blunt

Wundhäkchen, Wundhaken  
 Ganchito, Separadores

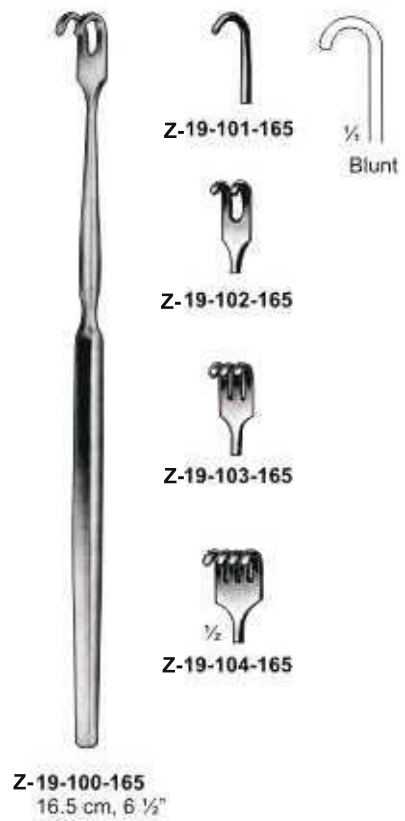
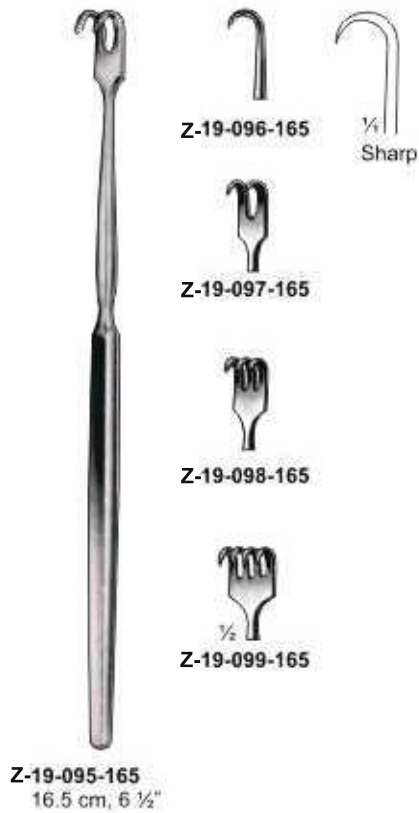



**ROLLET**  
Z-19-105-125  
12.5 cm, 4 1/4"



**ROLLET (Blair)**  
Z-19-106-135  
13.5 cm, 5"



**PAUL**  
Z-19-107-125  
12.5 cm, 4 3/4"



**Z-19-108-160**  
16 cm, 6 1/4"



**Z-19-109-135**  
13.5 cm, 5 1/4"



**MILLER**  
13.5 cm, 5 1/4"



Sharp  
Z-19-110-135

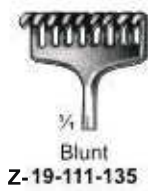

Blunt  
Z-19-111-135



**GROENHOLM**  
Z-19-112-130  
13 cm, 5"



**BROM**  
Z-19-113-170  
17 cm, 6 3/4"



**MOBERG**  
17 cm, 6 3/4"



14x5mm  
Z-19-114-170



17x5mm  
Z-19-115-170

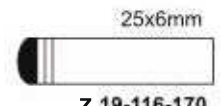

25x6mm  
Z-19-116-170

*Wundhäkchen, Wundhaken*  
*Ganchito, Separadores*

*Crochet, Ecarteurs*  
*Divaricatore, Divaricatori*



16.5 cm, 6 1/2"



Sharp



Z-19-117-165



Z-19-118-165



Z-19-119-165



Z-19-120-165



16.5 cm, 6 1/2"



Blunt



Z-19-121-165



Z-19-122-165



Z-19-123-165



Z-19-124-165

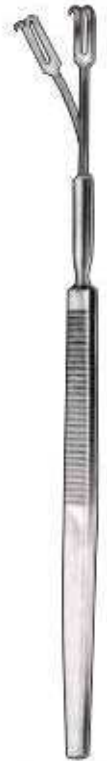

16 cm, 6 1/4"  
flexible



Z-19-125-160



Z-19-126-160



Z-19-127-160



Z-19-128-160



Z-19-129-160



Z-19-130-160



16.5 cm, 6 1/2"  
flexible



Z-19-131-165  
sharp



Z-19-132-165  
blunt

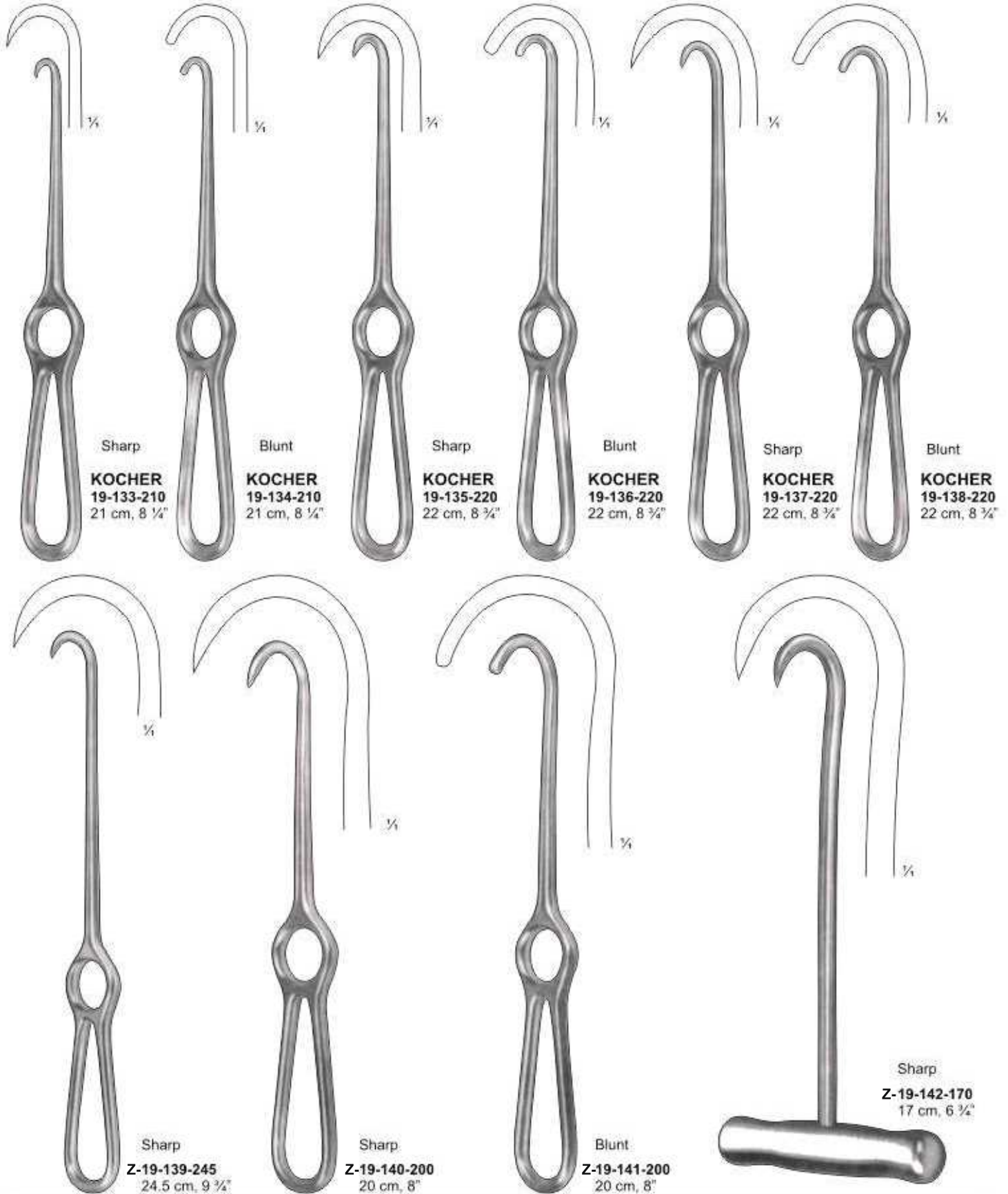

Wundhäkchen, Wundhaken  
Ganchito, Separadores

Crochet, Ecarteurs  
Divaricatore, Divaricatori



**VOLKMANN**  
Z-19-143-230  
23 cm, 9"



**VOLKMANN**  
Z-19-144-230  
23 cm, 9"



**LAMBOTTE**  
20 cm 18"  
Z-19-145-200  
13 x 235 mm  
Z-19-146-200  
20 x 255 mm  
Z-19-147-200  
27 x 270 mm



**VOLKMANN**  
11.5 cm, 4 1/2"



Z-19-148-115



Z-19-150-115



Z-19-155-115



Z-19-154-115



Z-19-149-115



Z-19-151-115



Z-19-153-115



Z-19-155-115



**MURPHY  
RETRACTORS**  
20 cm 18"  
Z-19-156-200 2 prongs  
Z-19-157-200 3 prongs  
Z-19-158-200 4 prongs  
Z-19-159-200 6 prongs  
Sharp/Blunt





**LANGENBECK-MINI**



**RETRACTOR**

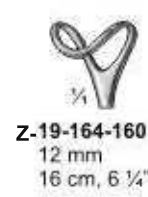

**NEIVERT**  
Z-19-168-160  
16 cm, 6  $\frac{1}{4}$ "



**LUKENS**  
Z-19-169-170  
17 cm, 6  $\frac{3}{4}$ "



**COPE**  
Z-19-170-180  
18 cm, 7"



**SENN MALLOW  
RETRACTOR**  
Z-19-171-160  
Blunt  
16 cm, 6 1/4"



**SENN MALLOW  
RETRACTOR**  
Z-19-172-160  
Sharp  
16 cm, 6 1/4"



**BABY-SENN  
MUELLER**  
Z-19-173-160  
7 x 8,5 mm  
16 cm, 6 1/4"  
sharp/blunt



**SENN-MUELLER**  
Z-19-174-160  
18 x 6 mm  
16 cm, 6 1/4"  
sharp



**VOLKMAN  
RETRACTOR**  
Z-19-175-220  
Sharp, 4 Prongs  
22 cm, 8 3/4"



**VOLKMAN  
RETRACTOR**  
Z-19-176-220  
Blunt, 4 Prongs  
22 cm, 8 3/4"



**STERNBERG**  
Z-19-177-120 12 cm, 4 3/4"  
Z-19-178-140 14 cm, 5 1/2"  
Z-19-179-160 16 cm, 6 1/4"

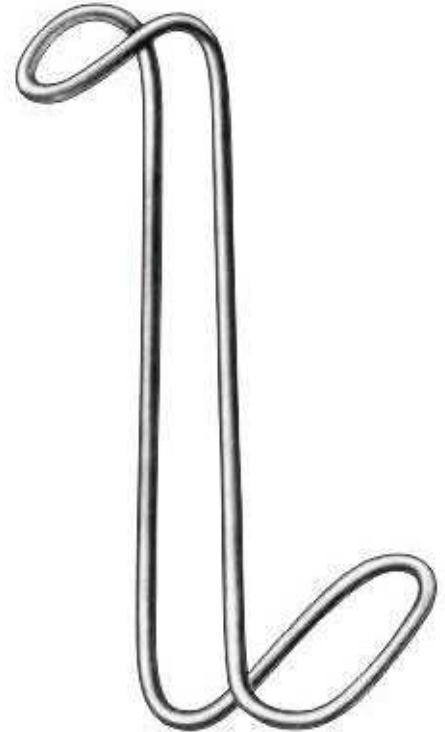

**COLLIN-HARTMANN**  
Z-19-180-140  
38 x 28 / 32 x 21 mm 14 cm, 5 1/2"  
Z-19-181-160  
52 x 34 / 36 x 27 mm 16 cm, 6 1/4"



**HERZFELD**  
Z-19-182-200  
20 cm, 8"



**STRANDELL-STILLE**  
Z-19-183-190  
19 cm, 7 1/2"



**STRANDELL-STILLE**  
Z-19-184-190  
19 cm, 7 1/2"



**SCHOENBORE**  
Z-19-185-210  
21 cm, 8 1/4"



**KONIG**

Z-19-186-170  
13 x 13 mm  
17 cm, 6 3/4"

Z-19-187-170  
12 x 16 mm  
17 cm, 6 3/4"



**SENN-GREEN**



Z-19-188-150  
10 x 6 mm  
15 cm, 6"

Z-19-189-150  
20 x 6 mm  
15 cm, 6"



**COTTLE**  
Z-19-190-150  
10 x 12 mm  
15 cm, 6"



**RAGNELL-DAVIS**  
Z-19-191-140  
8 x 4 mm  
Z-19-192-140  
15 x 5.5 mm  
14 cm, 5 1/2"

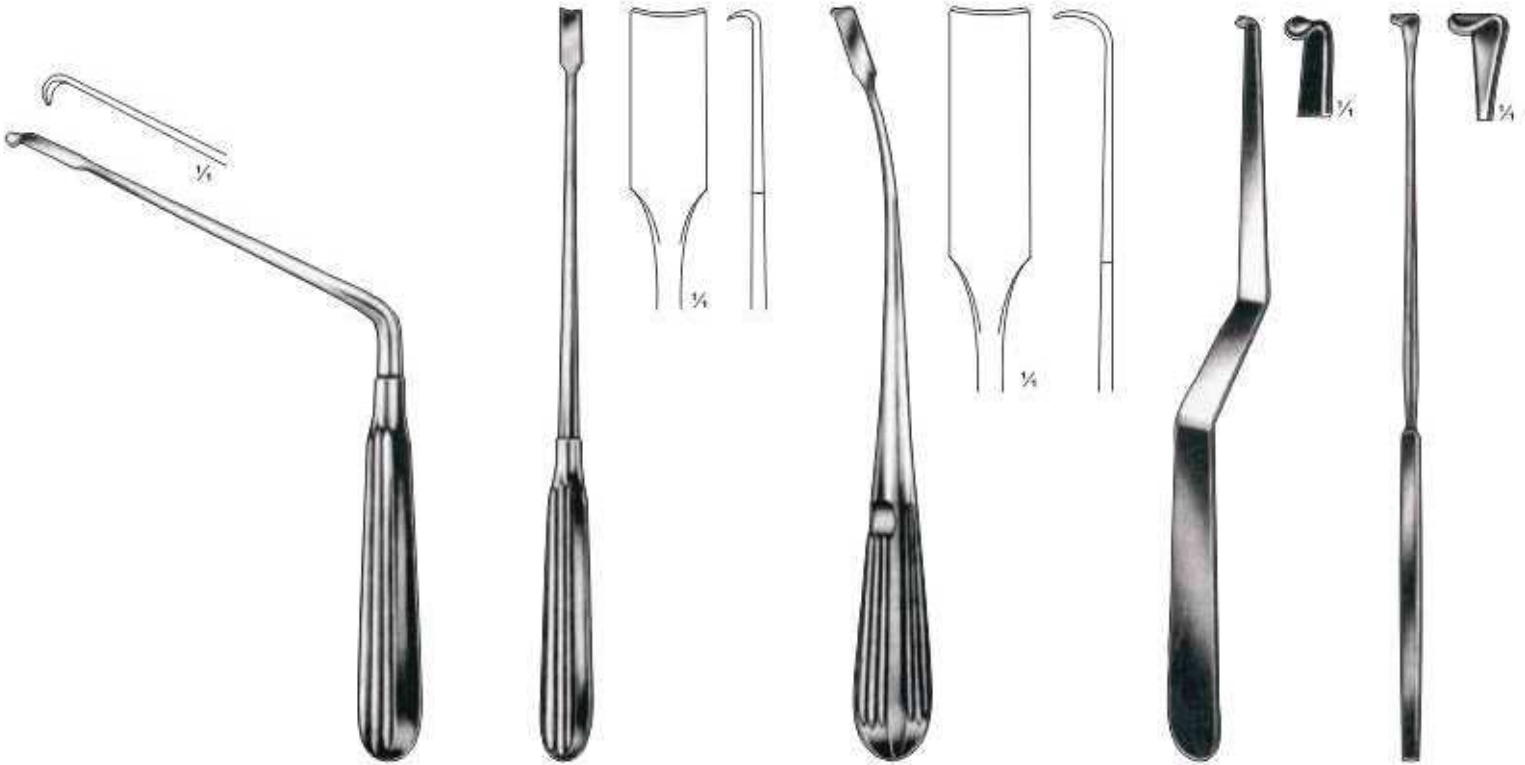

**SCOVILLE**  
Z-19-193-200  
7 mm  
20 cm, 8"

**SCOVILLE**  
Z-19-194-230  
8 mm  
23 cm, 9"

**HOLSHER**  
Z-19-195-240  
7 mm  
24 cm, 9 1/2"

**LOVE**  
Z-19-196-210  
4 mm  
21 cm, 8 1/4"

**LOVE**  
Z-19-197-190  
19 cm, 7 1/2"



**LOVE**  
Z-19-198-190  
19 cm, 7 1/2"



**LOVE**  
Z-19-199-190  
19 cm, 7 1/2"

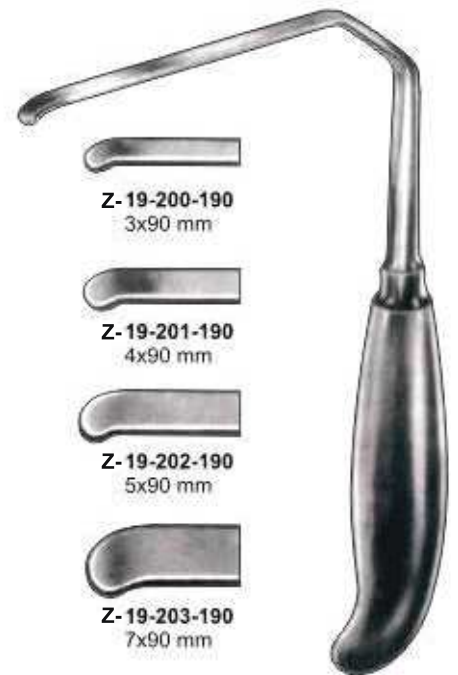

Z-19-200-190  
3x90 mm

Z-19-201-190  
4x90 mm

Z-19-202-190  
5x90 mm

Z-19-203-190  
7x90 mm

**HESS**  
19 cm, 7 1/2"

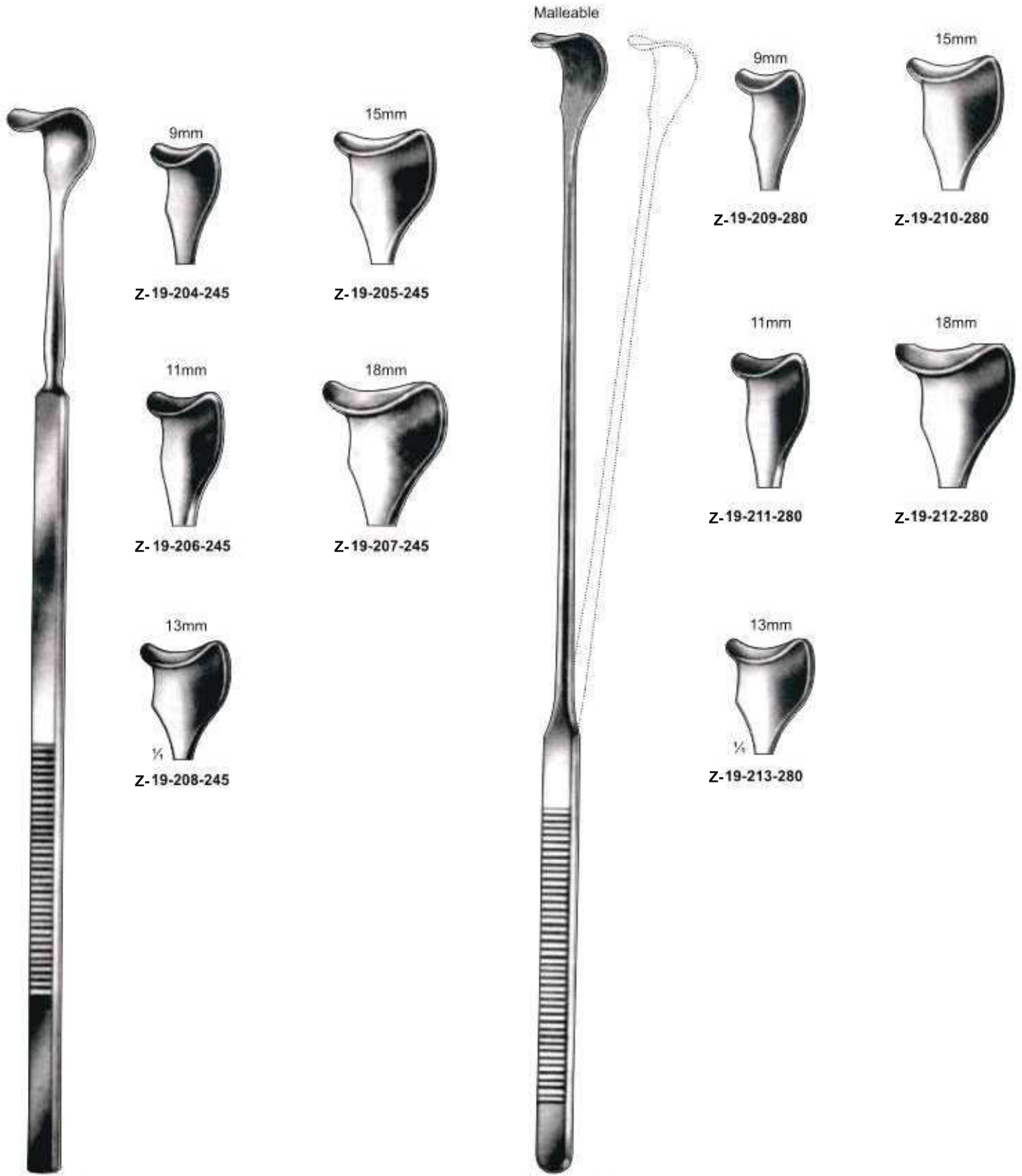

**GIL-VERNET**  
24.5 cm, 9 3/4"

**GIL-VERNET**  
28 cm, 11"



MANNERFELT



Fig.1  
**Z-19-214-155**  
12 x 12 mm  
15.5 cm, 6"



Fig.2  
**Z-19-215-155**  
12 x 14 mm  
15.5 cm, 6"



Fig.3  
**Z-19-216-155**  
12 x 16 mm  
15.5 cm, 6"



CUSHING



**Z-19-217-200**  
8 mm  
20 cm, 8"



**Z-19-218-200**  
10 mm  
20 cm, 8"



**Z-19-219-200**  
12 mm  
20 cm, 8"



**Z-19-220-200**  
14 mm  
20 cm, 8"



**Z-19-221-200**  
16 mm  
20 cm, 8"



**Z-19-222-200**  
18 mm  
20 cm, 8"



CUSHING



**Z-19-223-240**  
8 mm  
24 cm, 9 1/2"



**Z-19-224-240**  
10 mm  
24 cm, 9 1/2"



**Z-19-225-240**  
12 mm  
24 cm, 9 1/2"



**Z-19-226-240**  
14 mm  
24 cm, 9 1/2"



**Z-19-227-240**  
16 mm  
24 cm, 9 1/2"



**Z-19-228-240**  
18 mm  
24 cm, 9 1/2"



CUSHING



**Z-19-229-240**  
11 x 14 mm  
24 cm, 9 1/2"



**Z-19-230-240**  
13 x 18 mm  
24 cm, 9 1/2"



**Z-19-231-240**  
15 x 22 mm  
24 cm, 9 1/2"



CUSHING-KOCHER



**Z-19-232-180**  
10 x 10 mm  
18 cm, 7"



DESMARRES



**Z-19-233-160**  
7 x 8 mm  
16 cm, 6 1/4"



**Z-19-234-160**  
9 x 10 mm  
16 cm, 6 1/4"



**Z-19-235-160**  
9 x 12 mm  
16 cm, 6 1/4"



**Z-19-236-160**  
11 x 14 mm  
16 cm, 6 1/4"



**Z-19-237-160**  
13 x 16 mm  
16 cm, 6 1/4"



**Z-19-238-160**  
13 x 18 mm  
16 cm, 6 1/4"

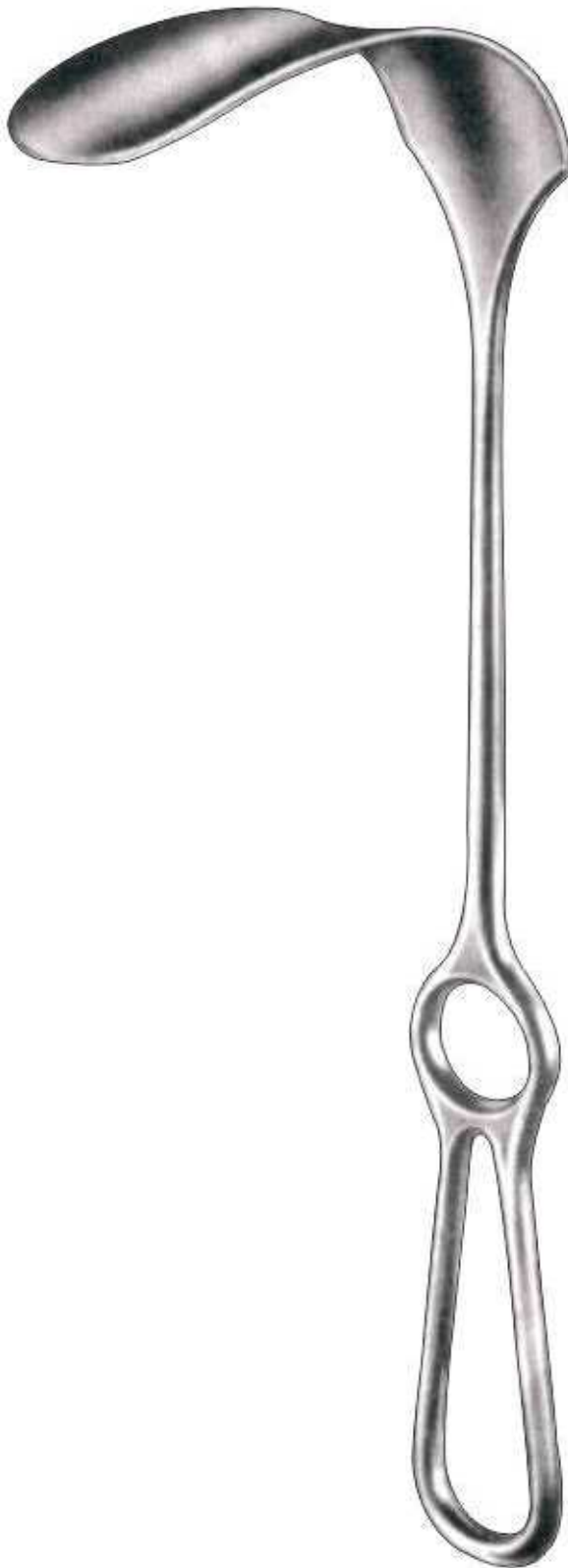

**KOCHER**  
28 cm 11"



Z-19-239-280



Z-19-240-280

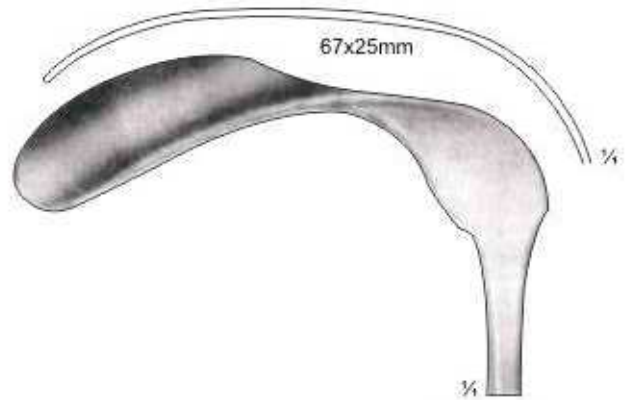

Z-19-241-280

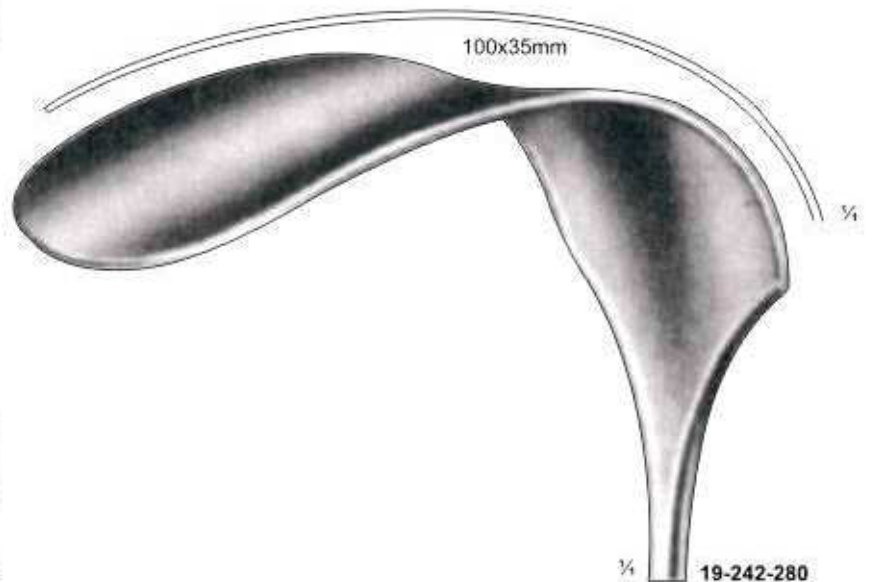

Z-19-242-280



**KOCHER**  
Sharp

- Z-19-243-220 22 cm, 8 3/4" 15 x 10 mm Fig. 1
- Z-19-244-220 22 cm, 8 3/4" 15 x 15 mm Fig. 2
- Z-19-245-220 22 cm, 8 3/4" 15 x 20 mm Fig. 3
- Z-19-246-220 22 cm, 8 3/4" 15 x 30 mm Fig. 4
- Z-19-247-220 22 cm, 8 3/4" 15 x 40 mm Fig. 5

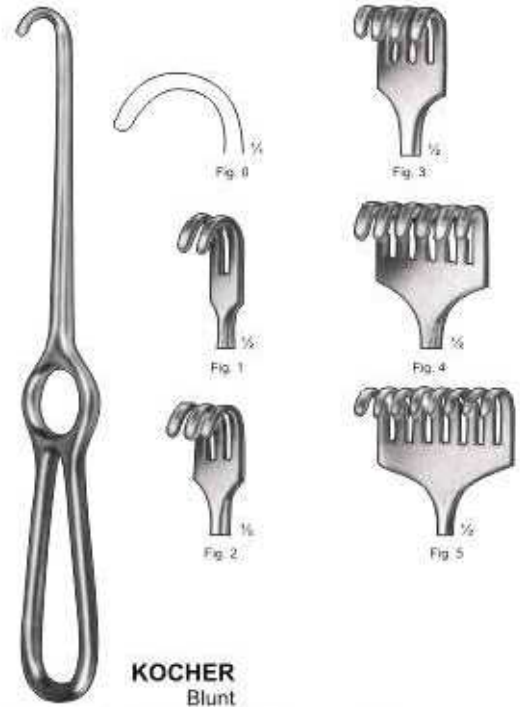

**KOCHER**  
Blunt

- Z-19-248-220 22 cm, 8 3/4" 15 x 10 mm Fig. 1
- Z-19-249-220 22 cm, 8 3/4" 15 x 15 mm Fig. 2
- Z-19-250-220 22 cm, 8 3/4" 15 x 20 mm Fig. 3
- Z-19-251-220 22 cm, 8 3/4" 15 x 30 mm Fig. 4
- Z-19-252-220 22 cm, 8 3/4" 15 x 40 mm Fig. 5

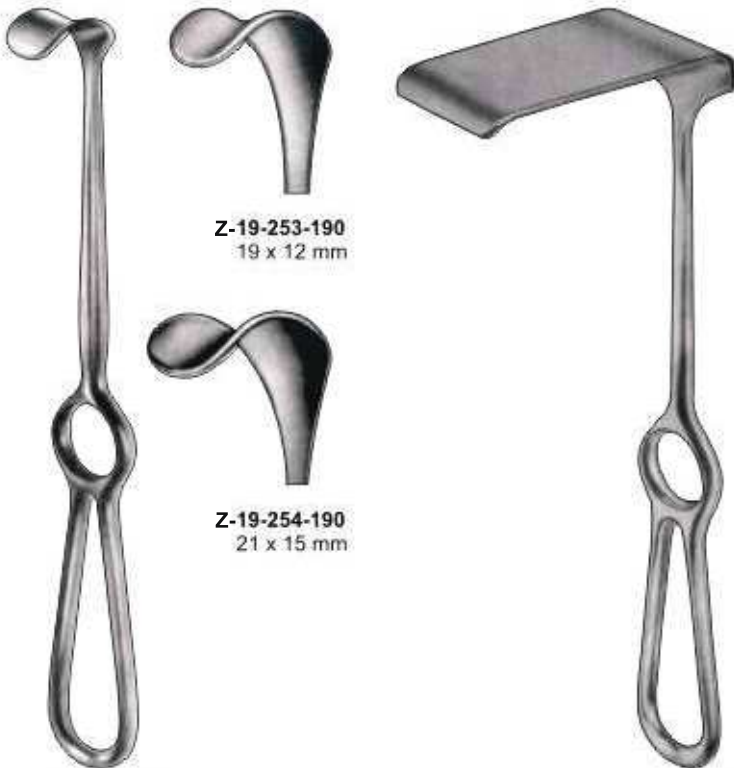

**KOCHER**  
19 cm, 7 1/2"

**KOCHER**  
23 cm, 9"

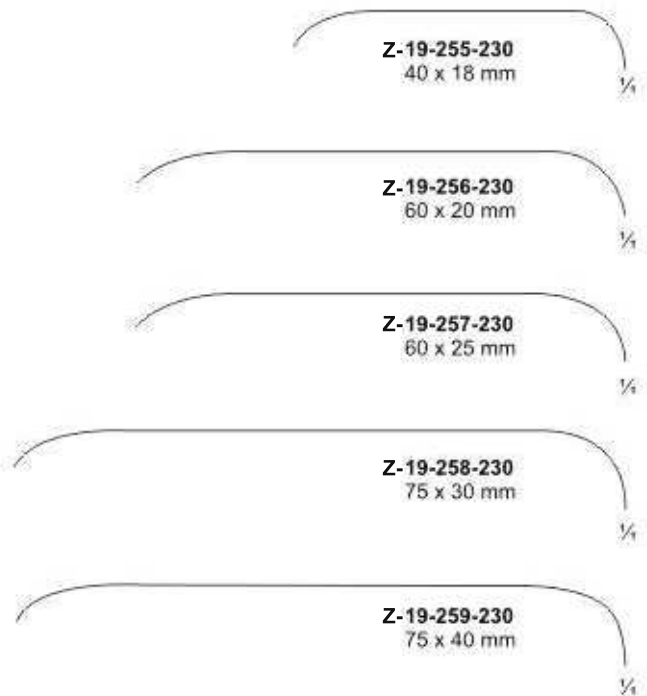

Z-19-255-230  
40 x 18 mm

Z-19-256-230  
60 x 20 mm

Z-19-257-230  
60 x 25 mm

Z-19-258-230  
75 x 30 mm

Z-19-259-230  
75 x 40 mm





**KOCHER-LANGENBECK**



**Z-19-260-215**  
25 x 6 mm  
21.5 cm, 8 1/2"



**Z-19-261-215**  
35 x 8 mm  
21.5 cm, 8 1/2"



**Z-19-262-215**  
35 x 11 mm  
21.5 cm, 8 1/2"



**Z-19-263-215**  
35 x 15 mm  
21.5 cm, 8 1/2"



**Z-19-264-215**  
40 x 11 mm  
21.5 cm, 8 1/2"



**Z-19-265-215**  
55 x 11 mm  
21.5 cm, 8 1/2"



**Z-19-266-215**  
70 x 14 mm  
21.5 cm, 8 1/2"



**Z-19-267-215**  
80 x 12 mm  
21.5 cm, 8 1/2"



**Z-19-268-215**  
80 x 16 mm  
21.5 cm, 8 1/2"



**KOCHER**  
**Z-19-269-220** 40 x 10 mm  
 22 cm, 8 3/4"  
**Z-19-270-220** 40 x 15 mm  
 22 cm, 8 3/4"  
**Z-19-271-220** 40 x 20 mm  
 22 cm, 8 1/2"



**KOCHER**  
**Z-19-272-225**  
 70 x 25 mm  
 22.5 cm 8 3/4"



**KOCHER**  
**Z-19-273-230** 23 cm, 9" 35 x 18 mm  
**Z-19-274-230** 23 cm, 9" 60 x 20 mm  
**Z-19-275-230** 23 cm, 9" 60 x 25 mm  
**Z-19-276-230** 23 cm, 9" 75 x 30 mm  
**Z-19-277-230** 23 cm, 9" 75 x 40 mm



**KOCHER**  
**19-278-250** 25 cm, 9 3/4" 80 x 45 mm  
**19-279-250** 25 cm, 9 3/4" 80 x 55 mm  
**19-280-250** 25 cm, 9 3/4" 80 x 65 mm



**KOCHER-  
WAGNER**



**Z-19-281-280**  
 22 x 15 mm  
 28 cm, 11"



**Z-19-282-280**  
 38 x 20 mm  
 28 cm, 11"



**Z-19-283-280**  
 67 x 25 mm  
 28 cm, 11"



**LANGENBECK**  
Z-19-284-215  
21.5 cm 8 1/2"  
Handle vertical  
to the blade.



**LANGENBECK**  
20 cm, 8"

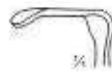

Z-19-285-200  
20 x 7 mm  
20 cm, 8"

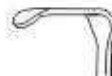

Z-19-286-200  
30 x 7 mm  
20 cm, 8"



Z-19-287-200  
30 x 11 mm  
20 cm, 8"



Z-19-288-200  
30 x 15 mm  
20 cm, 8"



Z-19-289-200  
30 x 20 mm  
20 cm, 8"



Z-19-290-200  
44 x 10 mm  
20 cm, 8"



Z-19-291-200  
44 x 15 mm  
20 cm, 8"



Z-19-292-200  
45 x 20 mm  
20 cm, 8"



Z-19-293-200  
50 x 20 mm  
20 cm, 8"

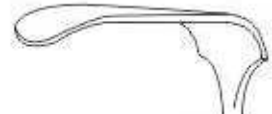

Z-19-294-200  
60 x 20 mm  
20 cm, 8"



**LANGENBECK**  
Z-19-295-210  
21 cm 8 1/4"  
38 x 9mm



**LANGENBECK**  
24 cm, 8 1/4"



Z-19-296-240  
35 x 7mm



Z-19-297-240  
35 x 11mm



Z-19-298-240  
35 x 15mm



Z-19-299-240  
35 x 20mm



**KNEE RETRACTOR**  
Z-19-300-225  
22.5 cm 8 3/4"  
37 x 9 mm



**LANGENBECK**  
Z-19-301-210  
21 cm 8 1/4"  
85 x 15 mm  
Handle vertical to blade



**LANGENBECK**  
Z-19-302-210  
21 cm, 8 1/4"  
53 x 20 mm  
Z-19-303-210  
21 cm, 8 1/4"  
61 x 20 mm



**LANGENBECK**  
Z-315-605-220  
22 cm, 8 1/2"



Z-19-304-220  
25 x 6 mm

Z-19-312-220  
25 x 6 mm



Z-19-305-220  
35 x 8 mm

Z-19-313-220  
35 x 8 mm



Z-19-306-220  
35 x 11 mm

Z-19-314-220  
35 x 11 mm



Z-19-307-220  
35 x 15 mm

Z-19-315-220  
35 x 15 mm



Z-19-308-220  
41 x 11 mm

Z-19-316-220  
41 x 11 mm



Z-19-309-220  
55 x 11 mm

Z-19-317-220  
55 x 11 mm



Z-19-310-220  
70 x 14 mm

Z-19-318-220  
70 x 14 mm



**LANGENBECK**  
Z-19-319-220  
22 cm, 8 1/2"





**Z-19-323-210**  
14 x 17 mm  
21 cm, 8 1/4"



**Z-19-324-210**  
20 x 22 mm  
21 cm, 8 1/4"



**Z-19-325-210**  
26 x 30 mm  
21 cm, 8 1/4"

**MIDDELDORPF**



**Z-19-326-210**  
40 x 12 mm  
21 cm, 8 1/4"



**Z-19-327-210**  
55 x 14 mm  
21 cm, 8 1/4"

**CASPAR**



25 mm

**OLLIER**  
**Z-19-328-185**  
18.5 cm, 7 1/4"



**LAHEY GOITER RETRACTOR**  
**Z-19-329-203** 20.3 cm, 8"  
Right angle blade, length  
1 inch (2.5cm). With lip.



28x6 mm

**LAHEY**  
**Z-315-630-190**  
19 cm, 7 1/2"

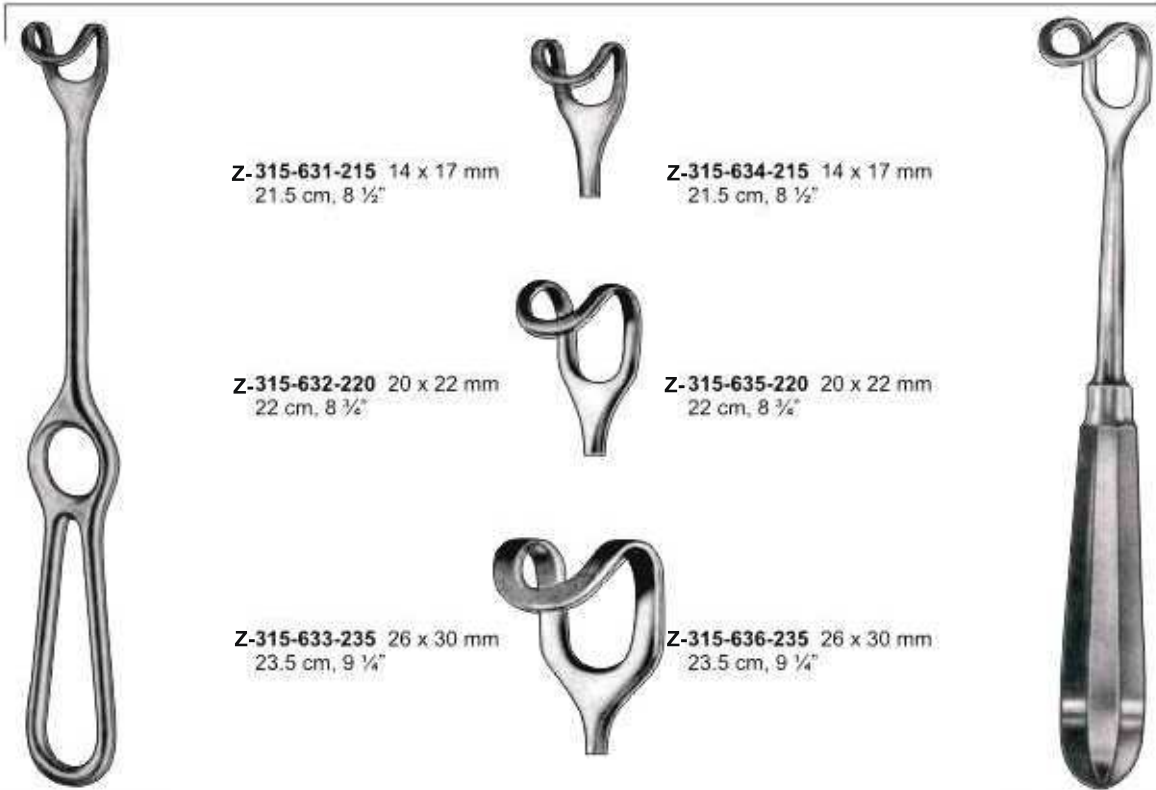

Z-315-631-215 14 x 17 mm  
21.5 cm, 8 1/2"

Z-315-634-215 14 x 17 mm  
21.5 cm, 8 1/2"

Z-315-632-220 20 x 22 mm  
22 cm, 8 3/4"

Z-315-635-220 20 x 22 mm  
22 cm, 8 3/4"

Z-315-633-235 26 x 30 mm  
23.5 cm, 9 1/4"

Z-315-636-235 26 x 30 mm  
23.5 cm, 9 1/4"

MIDDELDORPF

MIDDELDORPF



Z-315-638-255 45 x 50 mm  
25.5 cm, 10"



Z-315-639-255 55 x 70 mm  
25.5 cm, 10"



Z-315-640-220 25 x 12mm  
22 cm, 8 3/4"

MIDDELDORPF  
Z315-637-255 45 x 45 mm  
25.5 cm, 10"

GREEN  
22 cm, 8 3/4"





**Z-19-341-170**  
17 cm, 6 1/4"  
15 x 6 mm  
Fig. 1  
blunt

**Z-19-342-170**  
17 cm, 6 1/4"  
15 x 6 mm  
Fig. 2  
toothed

**STRANDELL-  
STILLE**



**SCHOENBORN**  
Z-19-343-210  
21 cm, 8 1/4"



**TENDON HOOKS**  
Z-19-344-175 17.5 cm, 7"  
Z-19-345-175 17.5 cm, 7"  
12 x 6 mm Fig. 1  
12 x 11 mm Fig. 2



**KLAPP**  
Z-19-346-175  
15 x 11 mm  
17.5 cm, 7"



**WASSMUND**  
Z-19-347-200  
20 cm, 8"  
33 x 20mm



**LITTLE**  
Z-19-348-200  
20 cm, 8"  
12x14 mm



**MEYERDING**  
18 cm, 7"



**Z-19-349-175**  
18 x 7 mm  
Blunt



**Z-19-351-175**  
7 x 4 mm  
Toothed



**Z-19-353-175**  
7 x 4 mm  
Saddle Shaped



**Z-19-350-175**  
16 x 5 mm  
Toothed



**Z-19-352-175**  
10 x 3 mm  
Blunt



**Z-19-354-175**  
10 x 4 mm  
Sharp



**BLOUNT**  
Z-19-355-175  
17.5 cm, 6 3/4"  
42 x 4 mm



**TAYLOR**  
Spinal Retractors  
Z-19-356-165 16.5 cm, 6 1/2"  
75 x 30 mm  
Z-19-357-165 16.5 cm, 6 1/2"  
100 x 30 mm



**LUER**  
Z-19-358-110 11 cm, 4 1/4"  
10 x 8 mm  
Z-19-359-110 11 cm, 4 1/4"  
12 x 11 mm



**ROSE**  
Z-19-360-130 13 cm, 5"  
12 x 12 mm  
12 x 15 mm



**CRILE**  
Z-19-361-110 11 cm, 4 1/4"  
12 x 4 mm  
20 x 6 mm



**MATHIEU**  
Set 2 pcs.  
Z-19-362-200 20 cm, 8"  
47 x 13 / 46 x 26 mm  
Z-19-363-200 20 cm, 8"  
42 x 13 / 42 x 26 mm



**US-ARMY**  
Set 2 pcs.  
Z-19-364-215 21.5 cm, 8 1/2"  
28 x 15 / 42 x 15 mm  
Z-19-365-215 21.5 cm, 8 1/2"  
25 x 15 / 38 x 15 mm



**RICHARDSON EASTMAN**  
Z-19-366-260  
26 cm, 10 1/4"  
small



**RICHARDSON EASTMAN**  
Z-19-367-280  
28 cm, 11"

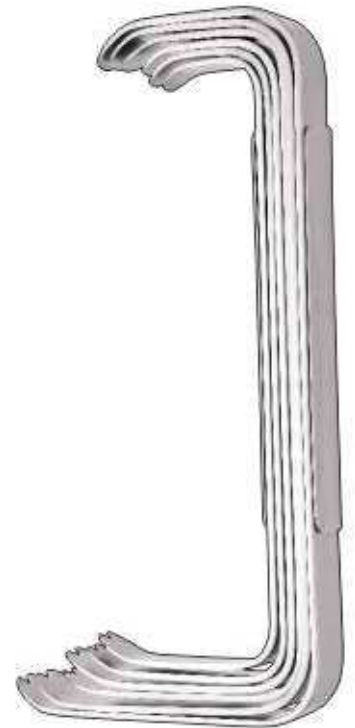

**USA RETRACTORS**  
Z-19-368-001  
set of 6 pec.

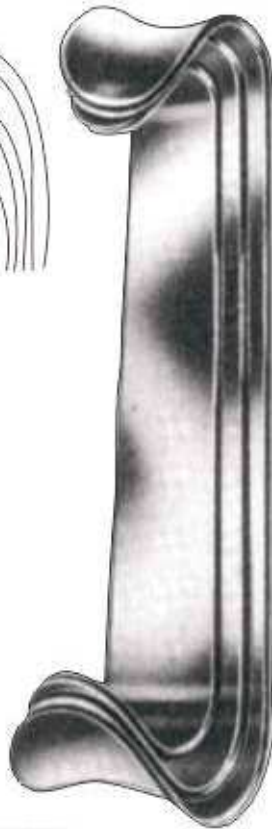
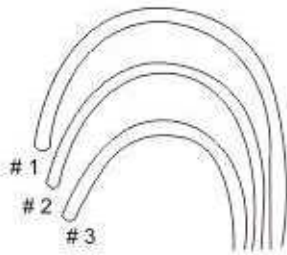

**ROUX**

Set 3 pcs. consisting of

- # Z-19-369-140 14 cm, 5 1/2" 24 x 20 / 30 x 28 mm
- # Z-19-370-150 15 cm, 6" 29 x 26 / 36 x 36 mm
- # Z-19-371-170 17 cm, 6 3/4" 33 x 29 / 38 x 43 mm



**BABY-ROUX**

- Z-19-372-130 13 cm, 5" 15 x 15 mm 18 x 21 mm



**ROUX**

- Z-19-373-165 16.5 cm, 6 1/2"



**ROUX**

- Z-19-374-185 18.5 cm, 7 1/4"

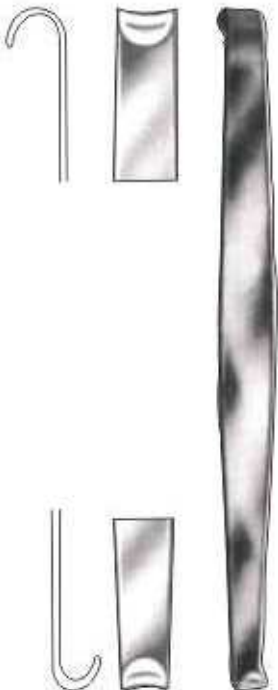

- MINI-ROUX**  
Z-19-375-140  
14 cm, 5 1/2"



- ROUX-MAGNUS**  
Z-19-376-150  
15 cm, 6"

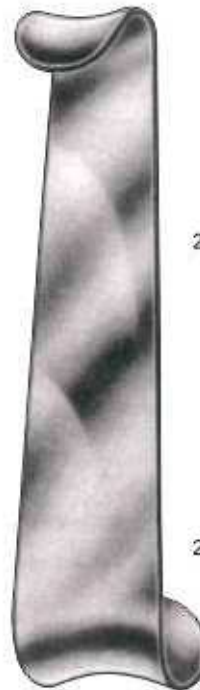

- ROUX-MAGNUS**  
Z-19-377-160  
16 cm, 6 1/4"

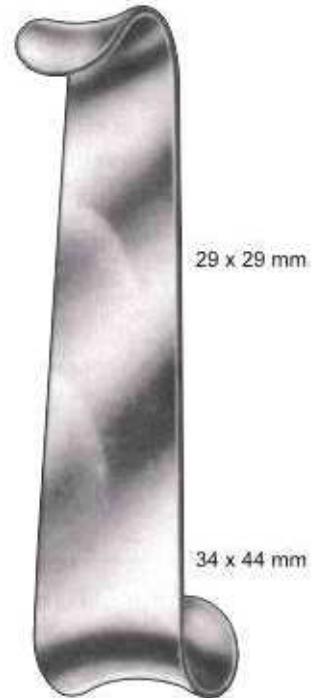

- ROUX-MAGNUS**  
Z-19-378-170  
17 cm, 6 3/4"



**FARABEUF**

Set 2 Pcs.

- Z-19-379-130 13 cm, 5"  
30 x 10 / 34 x 13 mm
- Z-19-380-130 13 cm, 5"  
26 x 10 / 30 x 13 mm

**FARABEUF**

Set 2 Pcs.

- Z-19-381-150 15 cm, 6"  
27 x 16 / 30 x 16 mm
- Z-19-382-150 15 cm, 6"  
23 x 16 / 26 x 16 mm

**PARKER**

Set 2 pcs.

- 19-383-135 13.5 cm, 5 1/4"  
22 x 15 mm / 22 x 15 mm

**PARKER**

- 19-384-135 13.5 cm, 5 1/4"  
18 x 15 mm / 19 x 15 mm



**COLLIN**

Set 2 pcs.

- Z-19-385-165 16.5 cm, 6 1/2"  
25 x 12 / 35 x 16 mm
- Z-19-386-165 16.5 cm, 6 1/2"  
20 x 12 / 30 x 16 mm

**MAYO-COLLIN**

Set 2 pcs.

- Z-19-387-150 15 cm, 6"  
28 x 18 / 25 x 18 mm

**PARKER-LANGENBECK**

Set of 2 Pcs.

- Z-19-388-215 21.5 cm, 8 1/2"  
25 x 15 mm fig. 2
- Z-19-389-215 21.5 cm, 8 1/2"  
21 x 15 mm fig. 1
- Z-19-390-215 21.5 cm, 8 1/2"  
40 x 15 mm fig. 1
- Z-19-391-215 21.5 cm, 8 1/2"  
46 x 15 mm fig. 2

**PARKER-MOTT**

Z-19-392-160

- 16 cm 6 1/4"  
68 x 24 / 74 x 24 mm



- Z-19-393-222**  
Blunt, 2 prongs.
- Z-19-394-222**  
Blunt, 3 prongs.
- Z-19-395-222**  
Blunt, 4 prongs.
- Z-19-396-222**  
Blunt, 5 prongs.
- Z-19-397-222**  
Blunt, 6 prongs.
- Z-19-398-222**  
Sharp, 2 prongs.
- Z-19-399-222**  
Sharp, 3 prongs.
- Z-19-400-222**  
Sharp, 4 prongs.
- Z-19-401-222**  
Sharp, 5 prongs.
- Z-19-402-222**  
Sharp, 6 prongs.

**VOLKMANN  
RETRACTORS**  
Long Pattern  
22.2 cm



**KOERTE**  
blunt  
**Z-19-404-240**  
26 x 40 mm  
24 cm, 9 1/2"

**KOERTE**  
sharp  
**Z-19-403-240**  
26 x 40 mm  
24 cm, 9 1/2"



**KOERTE**  
blunt  
**Z-19-405-230**  
46 x 55 mm  
23 cm, 9"



**KOERTE**  
semi-sharp  
**Z-19-406-280**  
25 x 40 mm  
28 cm, 11"



**KOERTE**  
**Z-19-407-230**  
23 cm, 9"  
Blunt



**KORTE-  
WAGNER**  
**Z-19-408-280**  
28 cm, 11"  
blunt

Wundhaken  
 Separadores



VOLKMANN

Sharp

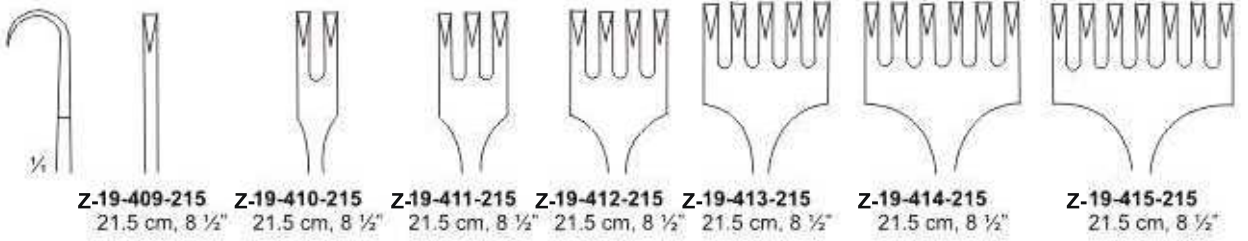

Blunt

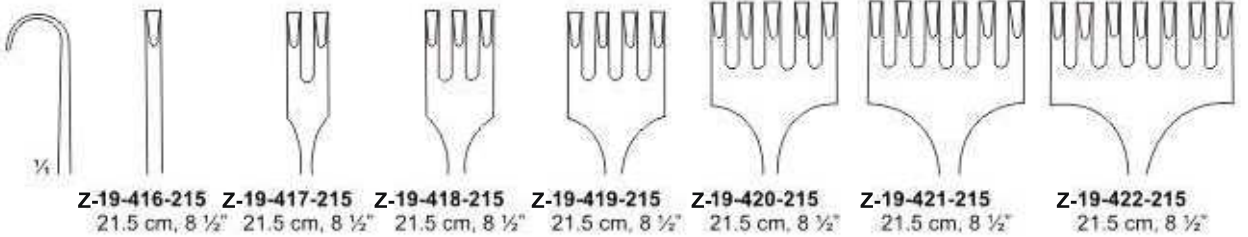

Sharp

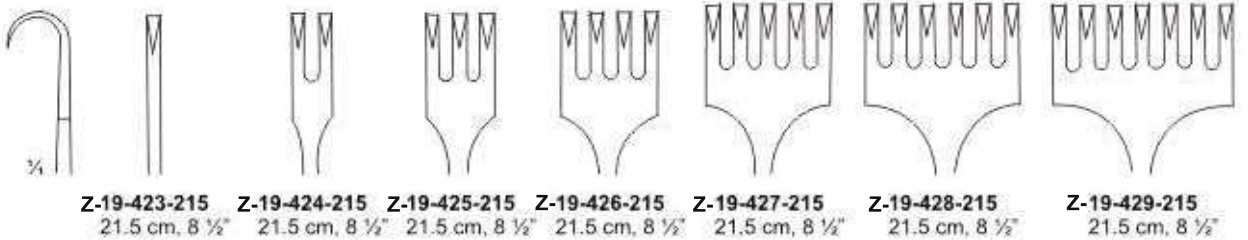

Blunt

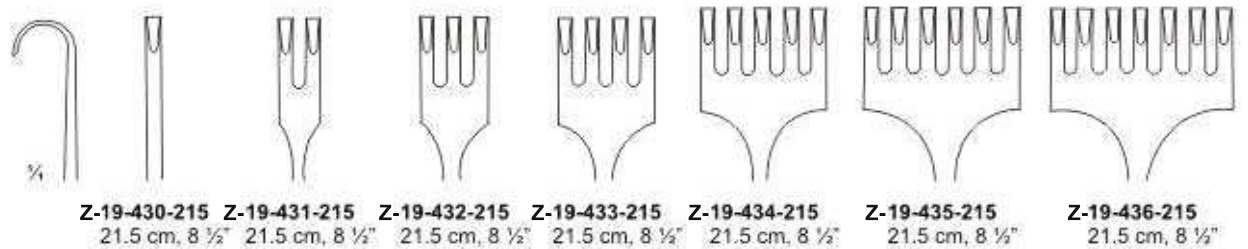

VOLKMANN

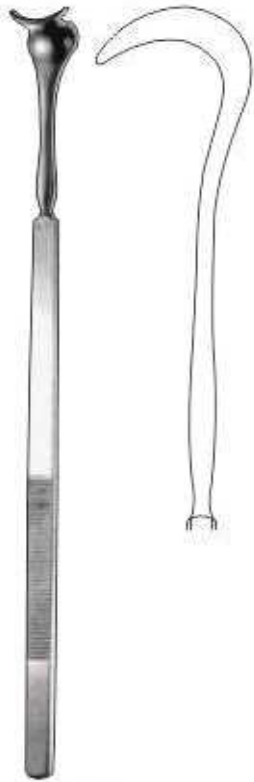

**GIL-VERNET**  
24 cm, 9 1/2"

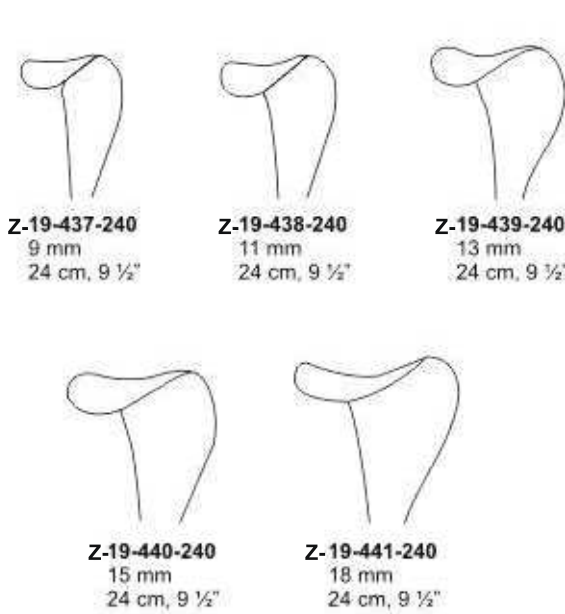

**SAUERBRUCH**

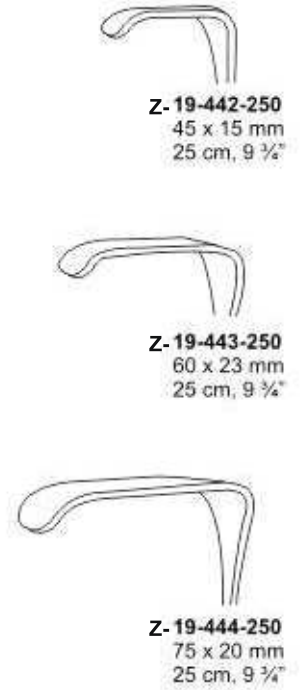

**OLLIER**  
blunt

- Z-19-445-230** 23 cm, 9" 36 x 30 mm Fig. 1  
**Z-19-446-230** 23 cm, 9" 36 x 60 mm Fig. 2



**ISRAEL**  
blunt

- Z-19-447-225**  
22.5 cm, 8 3/4"  
Blunt



- ISRAEL**  
blunt  
**Z-19-448-250** 25 cm, 9 3/4" 40 x 40 mm Fig. 1  
**Z-19-449-250** 25 cm, 9 3/4" 45 x 50 mm Fig. 2  
**Z-19-450-250** 25 cm, 9 3/4" 50 x 60 mm Fig. 3  
**Z-19-451-250** 25 cm, 9 3/4" 70 x 70 mm Fig. 4

Z-19-452-225  
115 x 65 mm

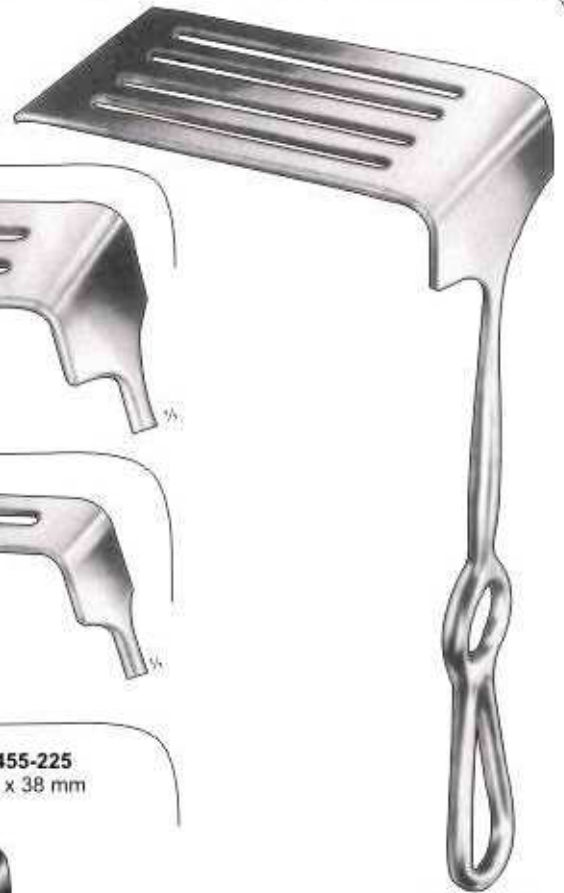

Z-19-453-225  
115 x 38 mm



Z-19-454-225  
82 x 22 mm



Z-19-455-225  
130 x 38 mm

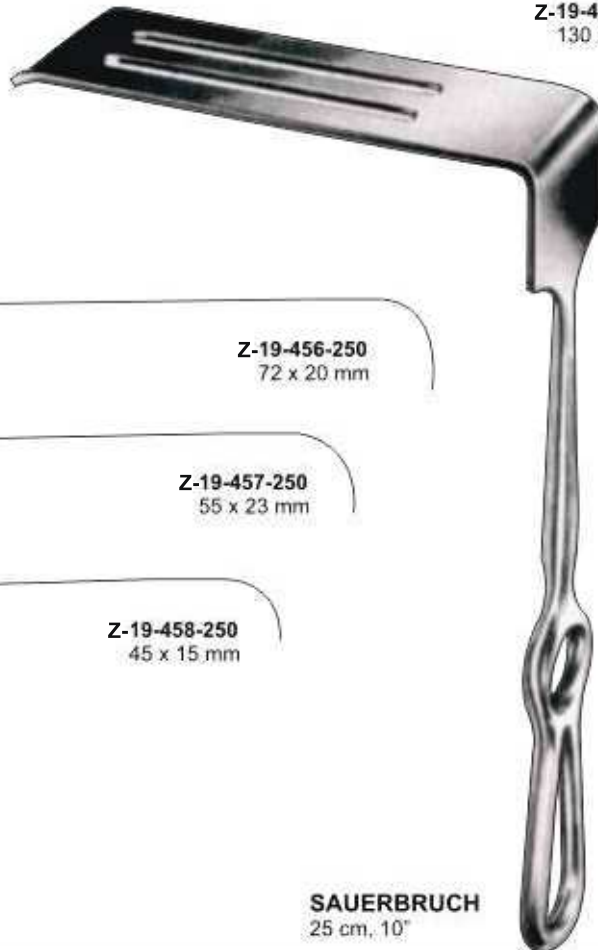

CORYLLOS  
22.5 cm, 8 1/4"

Z-19-456-250  
72 x 20 mm



Z-19-457-250  
55 x 23 mm



Z-19-458-250  
45 x 15 mm

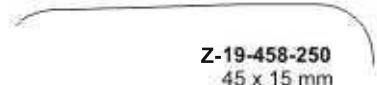

SAUERBRUCH  
25 cm, 10"

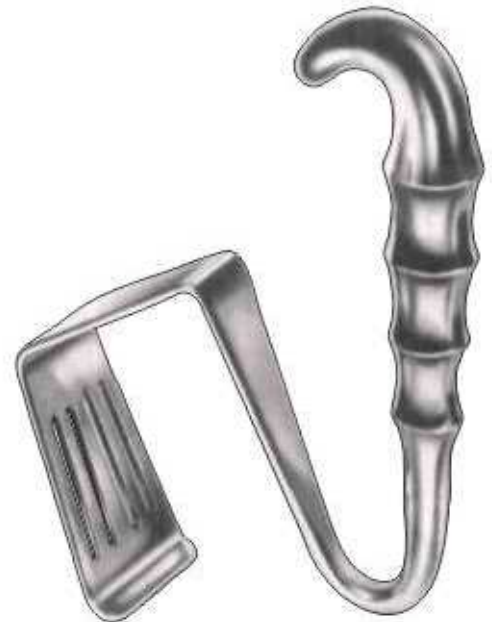

DAVIDSON  
Z-19-459-160 16 cm, 6 1/4" 75 x 50 mm  
Z-19-460-160 16 cm, 6 1/4" 75 x 90 mm



Z-19-461-250  
180 x 30 mm

Z-19-462-250  
160 x 30 mm

Z-19-463-250  
140 x 30 mm

Z-19-464-250  
130 x 30 mm

Z-19-465-250  
120 x 25 mm

Z-19-466-250  
100 x 25 mm

Z-19-467-250  
80 x 20 mm



**BRUNER**  
25 cm, 10"

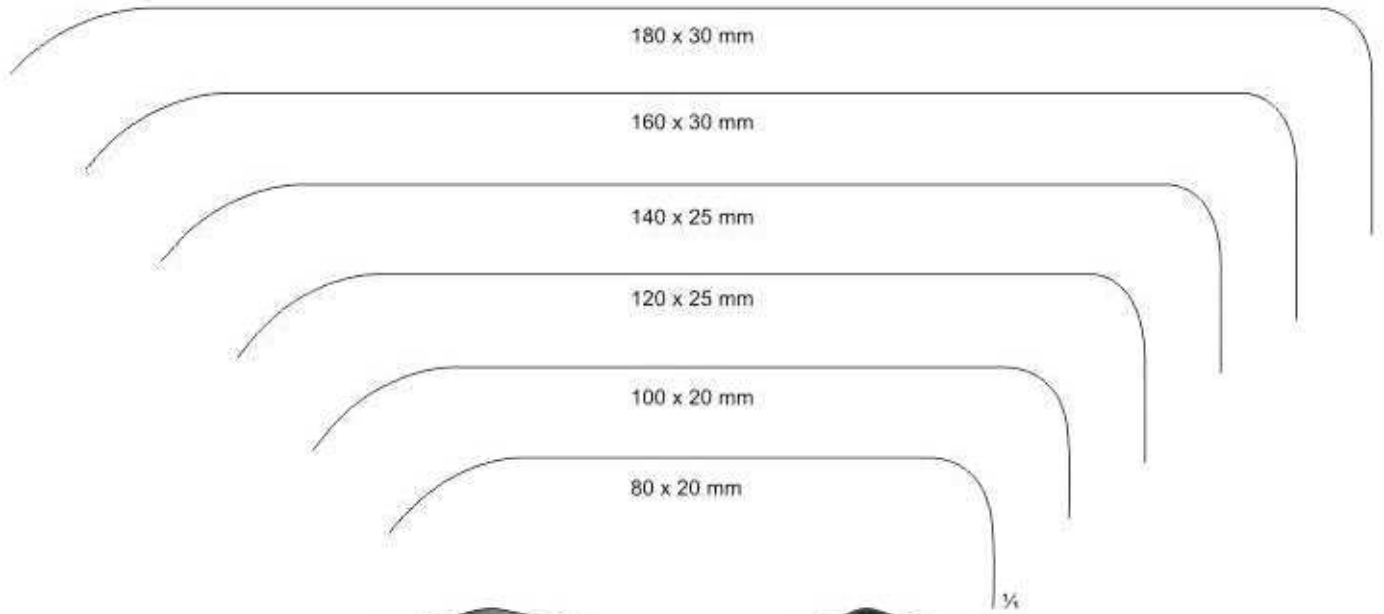

- Z-19-468-240 80 x 20 mm
- Z-19-469-240 100 x 20 mm
- Z-19-470-240 120 x 25 mm
- Z-19-471-240 140 x 25 mm
- Z-19-472-240 160 x 30 mm
- Z-19-473-240 180 x 30 mm

**BRUNNER**  
24 cm, 9 1/2"



- Z-19-474-240 80 x 20 mm
- Z-19-475-240 100 x 20 mm
- Z-19-476-240 120 x 25 mm
- Z-19-477-240 140 x 25 mm
- Z-19-478-240 160 x 30 mm
- Z-19-479-240 180 x 30 mm

**BRUNNER**  
24 cm, 9 1/2"



**SAUERBRUCH**  
22.5 cm, 9"



**Z-19-480-225**  
22.5 cm, 9"  
50 x 15 mm



**Z-19-481-225**  
22.5 cm, 9"  
63 x 23 mm



**Z-19-482-225**  
22.5 cm, 9"  
80 x 20 mm



**DOYEN-STILLE**  
**AZ-19-483-260** 26 cm, 10 1/4"  
97 x 29 mm  
**BZ-19-484-260** 26 cm, 10 1/4"  
101 x 31 mm  
**CZ-19-485-260** 26 cm, 10 1/4"  
152 x 27 mm

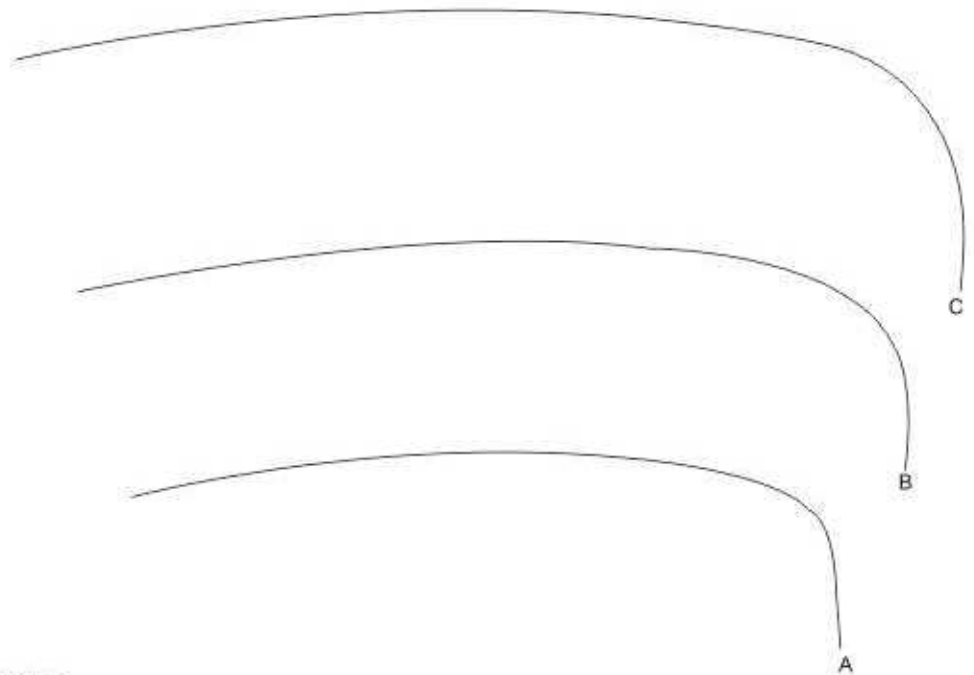



**HOSEL**  
25 cm, 10"



**Z-19-486-250**  
60 x 20 mm



**Z-19-487-250**  
80 x 30 mm

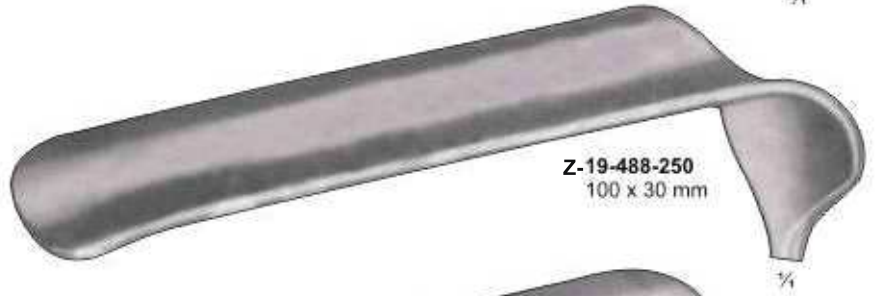

**Z-19-488-250**  
100 x 30 mm



**Z-19-489-250**  
120 x 30 mm



**Z-19-490-250**  
140 x 30 mm



**Z-19-491-250**  
140 x 40 mm





**DEAVER**  
Z-19-498-300  
30 cm, 11 3/4"

**DEAVER**  
Z-19-499-300  
30 cm, 11 3/4"

**DEAVER**  
Z-19-500-300  
30 cm, 11 3/4"

**S-SHAPED**  
Z-19-501-210  
21 cm, 8 1/4"  
12 mm

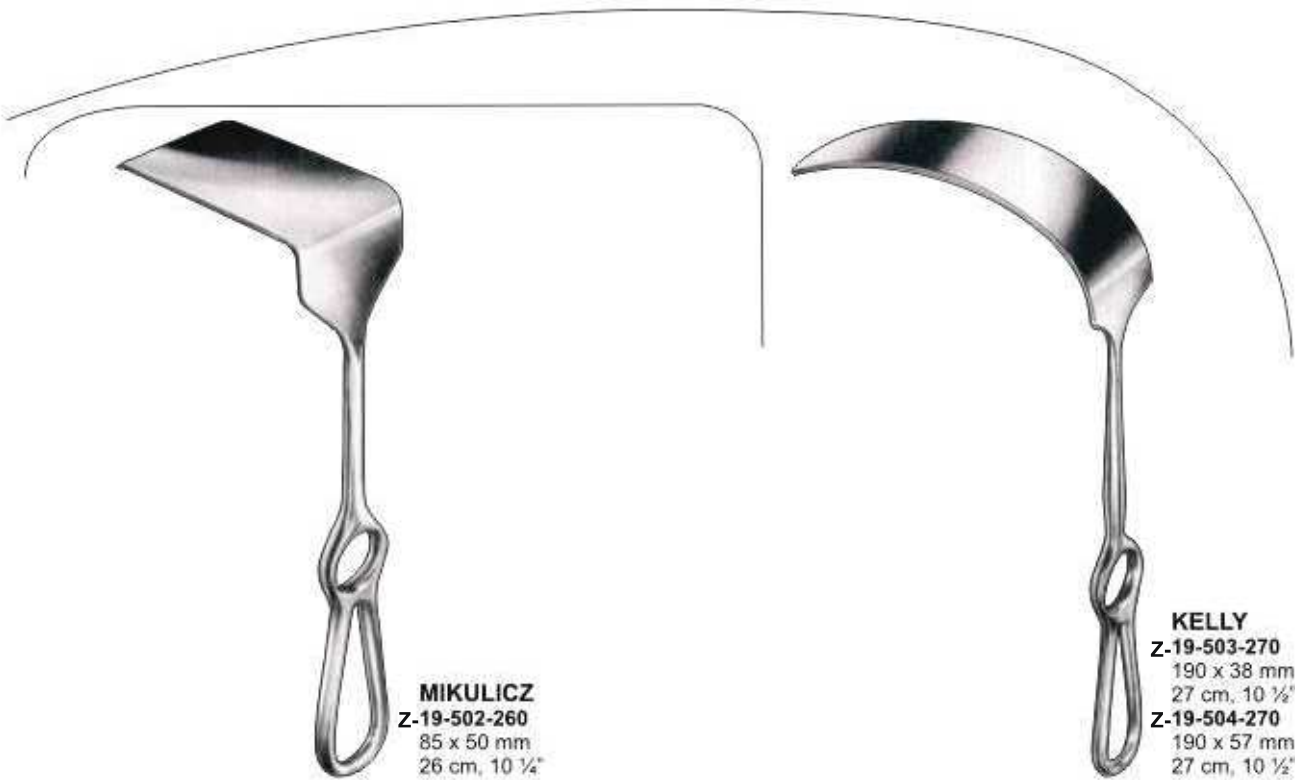

**MIKULICZ**  
Z-19-502-260  
85 x 50 mm  
26 cm, 10 1/4"

**KELLY**  
Z-19-503-270  
190 x 38 mm  
27 cm, 10 1/2"  
Z-19-504-270  
190 x 57 mm  
27 cm, 10 1/2"

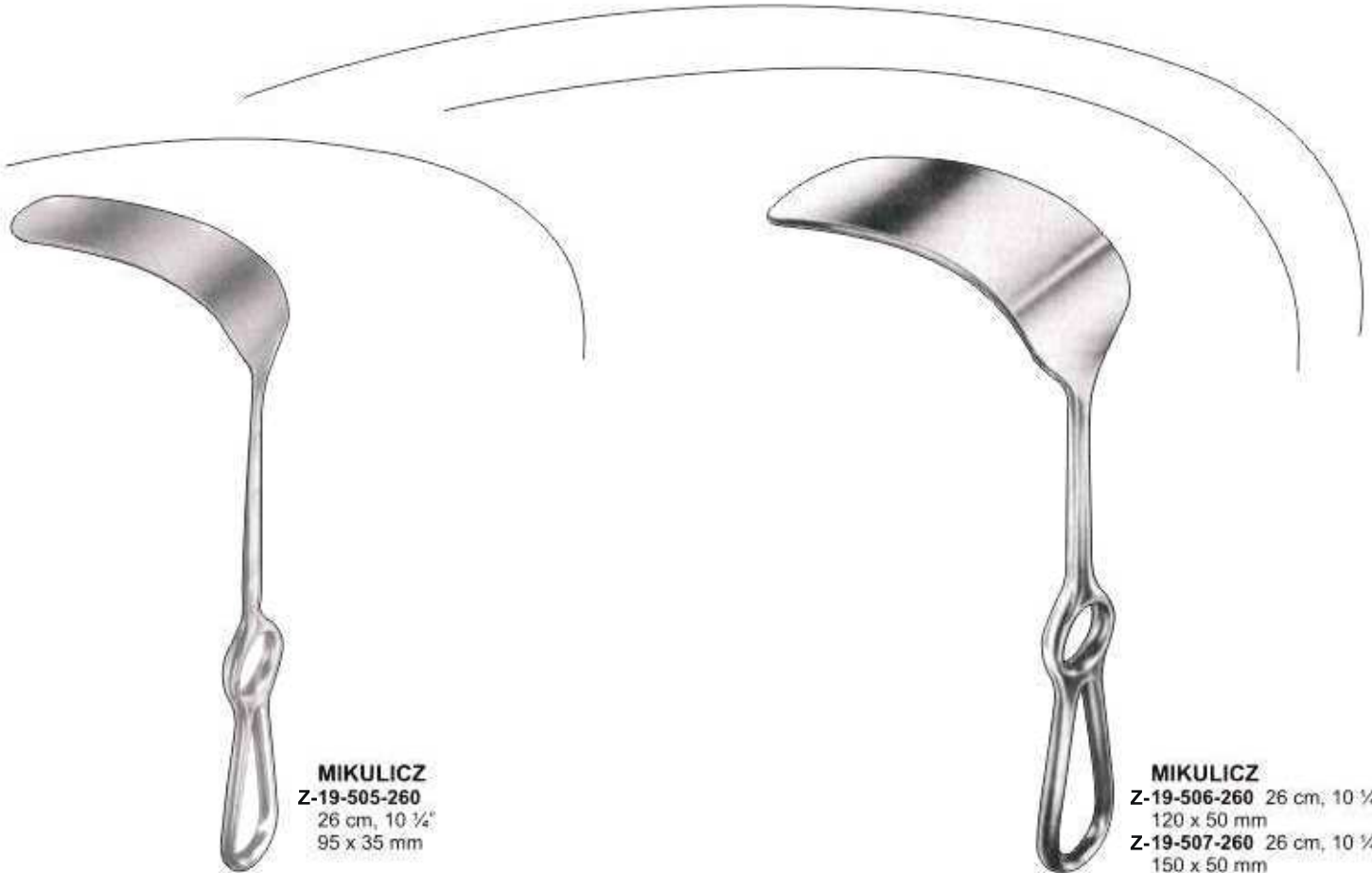

**MIKULICZ**  
Z-19-505-260  
26 cm, 10 1/4"  
95 x 35 mm

**MIKULICZ**  
Z-19-506-260 26 cm, 10 1/4"  
120 x 50 mm  
Z-19-507-260 26 cm, 10 1/4"  
150 x 50 mm



**CHEEK-AND LIP  
RETRACTOR  
MOVABLE**  
Z-19-508-190  
19 cm, 7 1/2"



**TUFFIER**  
Z-19-509-230 55 x 63 mm  
23 cm, 9"



**DOYEN**  
Z-19-510-250 50 x 85 mm  
25 cm, 10"



**FRITCH RETRACTOR**  
Z-19-511-001  
2.75 x 2 mm



**FRITSCH**  
Z-19-512-240 35 x 40 mm  
24 cm, 9 1/2"



**FRITSCH**  
Z-19-513-240 24 cm, 9 1/2" 30 x 30 mm  
Z-19-514-240 24 cm, 9 1/2" 32 x 40 mm  
Z-19-515-240 24 cm, 9 1/2" 40 x 50 mm  
Z-19-516-240 24 cm, 9 1/2" 40 x 60 mm  
Z-19-517-240 24 cm, 9 1/2" 45 x 75 mm  
Z-19-518-240 24 cm, 9 1/2" 65 x 85 mm



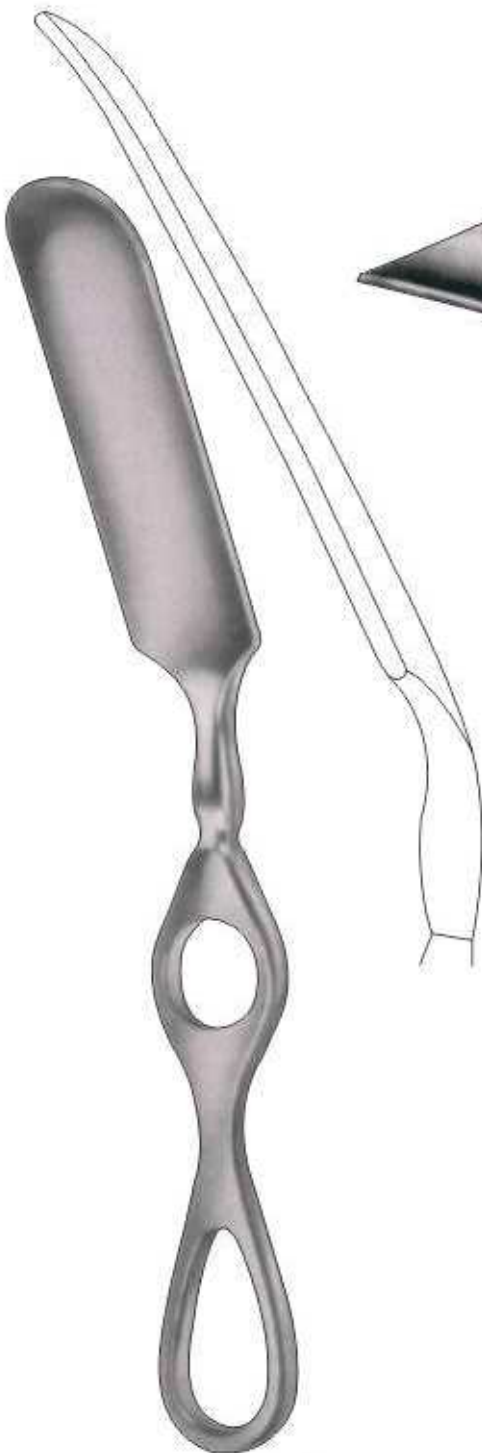

**MIKULICZ**  
Z-19-519-290  
29 cm 11.5"

64 x 60mm

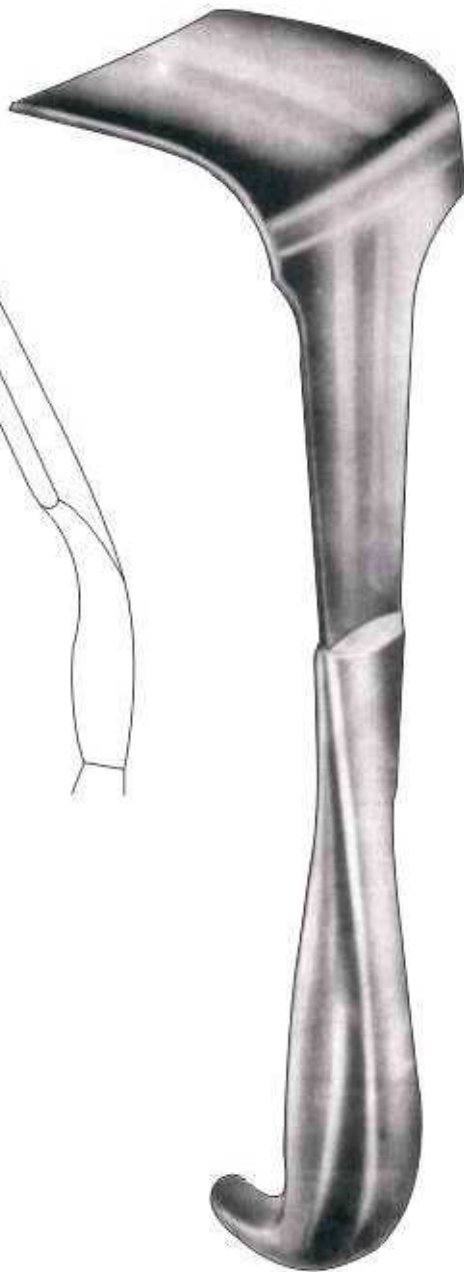

**TUFFIER**  
Z-19-520-230  
23 cm 9"



**HARRINGTON**  
Z-19-521-320  
32 cm, 12 3/4" 127 x 40 mm  
Z-19-522-320  
32 cm, 12 3/4" 127 x 62 mm



DEAVER  
Z-19-523-310  
31.0 cm 12"



DEAVER  
Z-19-524-310  
31.0 cm 12"



**DEAVER**  
Z-19-525-305  
30.5 cm 12"



**DEAVER**  
Z-19-526-310  
31.0 cm 12"

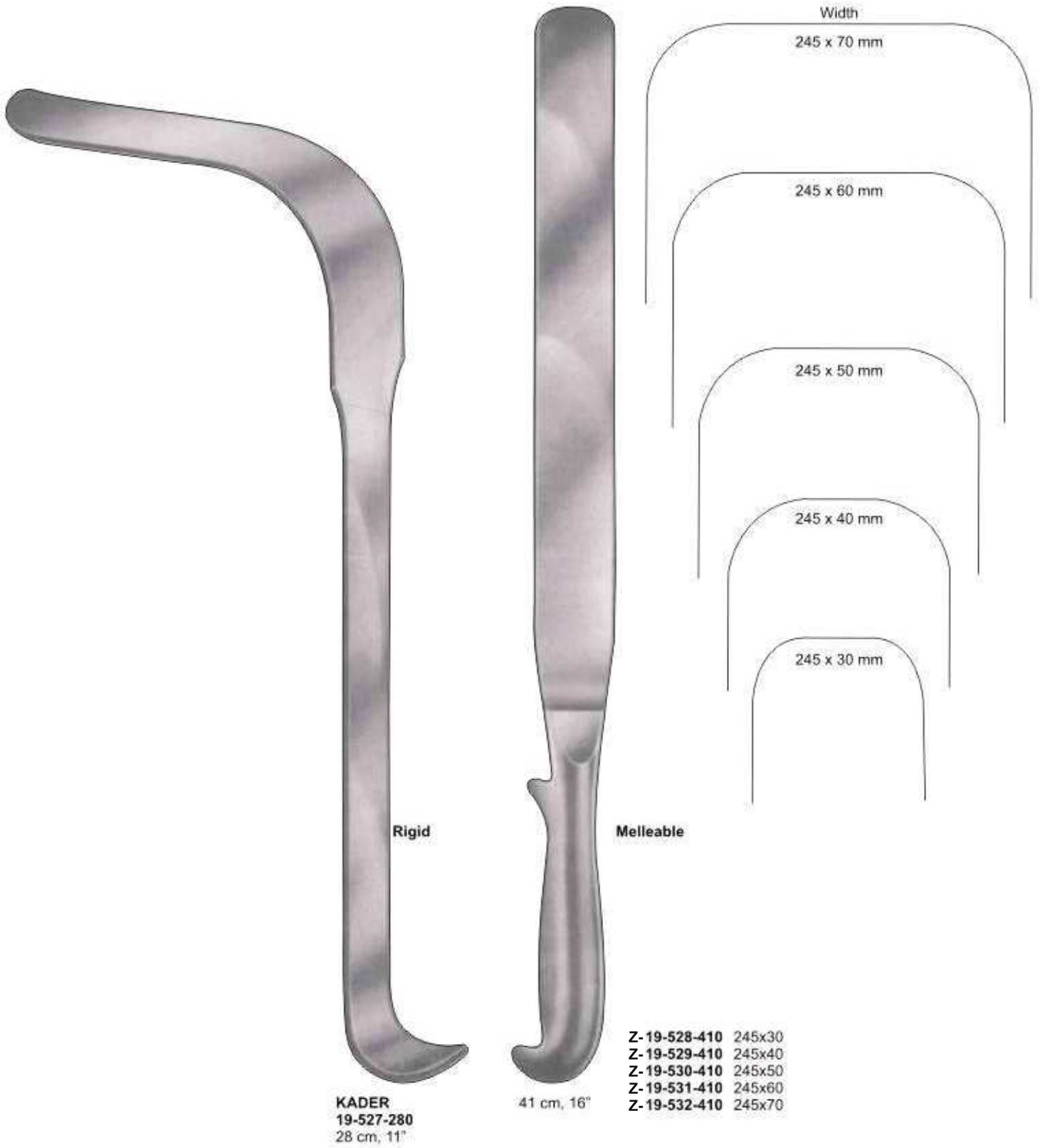



**LERICHE**  
Z-19-533-310  
31 cm, 12 1/2"

**LERICHE**  
Z-19-534-330  
33 cm, 13"

**KUEMMEL**  
Z-19-535-330  
malleable  
33 cm, 13"  
46 mm

**KUMMEL**  
Z-19-536-330  
33 cm, 13"





**MEYERDING**  
Z-19-541-225 75 x 25mm  
22.5 cm, 9"



Z-19-542-225 50 x 16mm  
22.5 cm, 9"



Z-19-543-225 75 x 15mm  
22.5 cm, 9"



**GOELET**  
Z-19-544-190  
19 cm 7 1/2"  
Double Ended



30 x 30 mm

40 x 40 mm



**KAYE-MILLARD**  
Z-19-545-080  
8 cm, 3 1/4"



**RICHARDSON/KELLY**



Z-19-546-240 25 x 31mm  
24 cm, 9 1/2"



Z-19-547-240 19 x 51mm  
24 cm, 9 1/2"



Z-19-548-240 38 x 51mm  
24 cm, 9 1/2"



Z-19-549-240 64 x 76mm  
24 cm, 9 1/2"



**ROSS**  
25.5 cm, 10"



**Z-19-550-255**  
Fig.01



**Z-19-551-255**  
Fig.02



**Z-19-552-255**  
Fig.03



**Z-19-553-255**  
Fig.04



**Z-19-554-255**  
Fig.05



**Z-19-555-255**  
Fig.06



**WEINBERG VAGOTOMY  
RETRACTOR (JOE'S HOE)**  
**Z-19-556-200**  
20 cm, 8"  
Blade 102 x 165 mm wide



**TURNER-DOYEN  
RETRACTORS**  
**Z-19-557-235**  
Blade 140 x 60 mm wide  
**Z-19-558-235**  
Blade 76 x 140 mm wide  
**Z-19-559-235**  
Blade 165 x 76 mm wide  
23.5 cm 9 1/4"

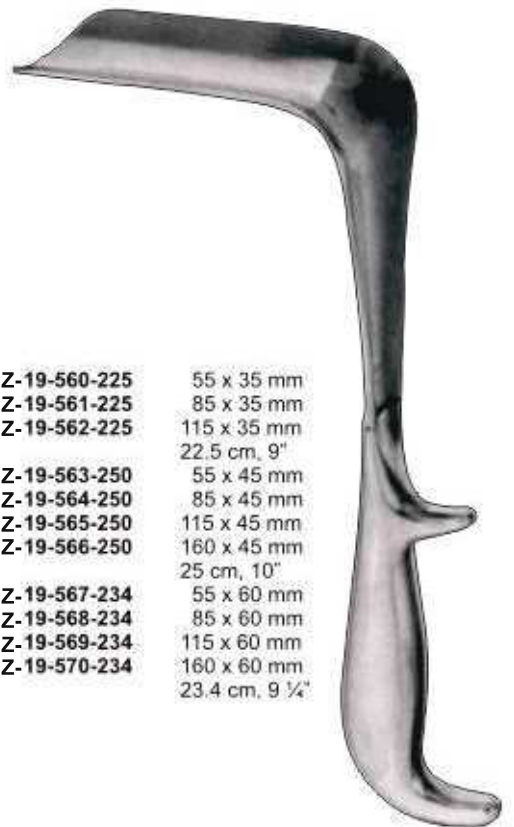

**Z-19-560-225** 55 x 35 mm  
**Z-19-561-225** 85 x 35 mm  
**Z-19-562-225** 115 x 35 mm  
22.5 cm, 9"  
**Z-19-563-250** 55 x 45 mm  
**Z-19-564-250** 85 x 45 mm  
**Z-19-565-250** 115 x 45 mm  
**Z-19-566-250** 160 x 45 mm  
25 cm, 10"  
**Z-19-567-234** 55 x 60 mm  
**Z-19-568-234** 85 x 60 mm  
**Z-19-569-234** 115 x 60 mm  
**Z-19-570-234** 160 x 60 mm  
23.4 cm, 9 1/4"

**DOYEN VAGINAL  
RETRACTORS**





**LEGUEU**  
Z-19-571-270  
35 x 90 mm  
27 cm 10 1/2"  
Bladder Spatula

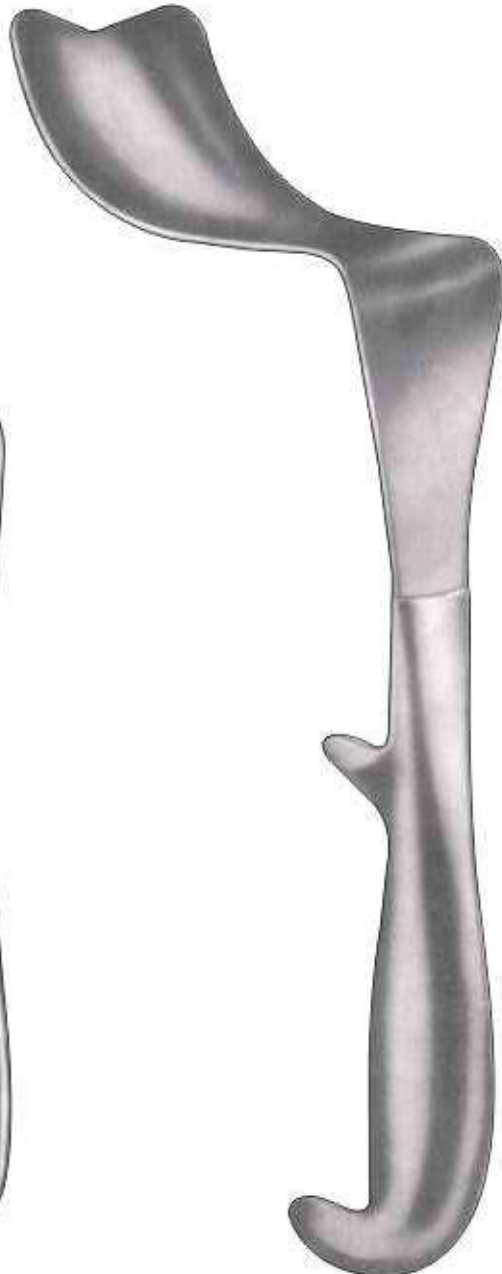

**KOCHER**  
Z-19-572-260  
56 x 90 mm  
26 cm 10 1/4"



**KOCHER**  
Z-19-573-260  
65 x 90 mm  
26 cm 10 1/4"

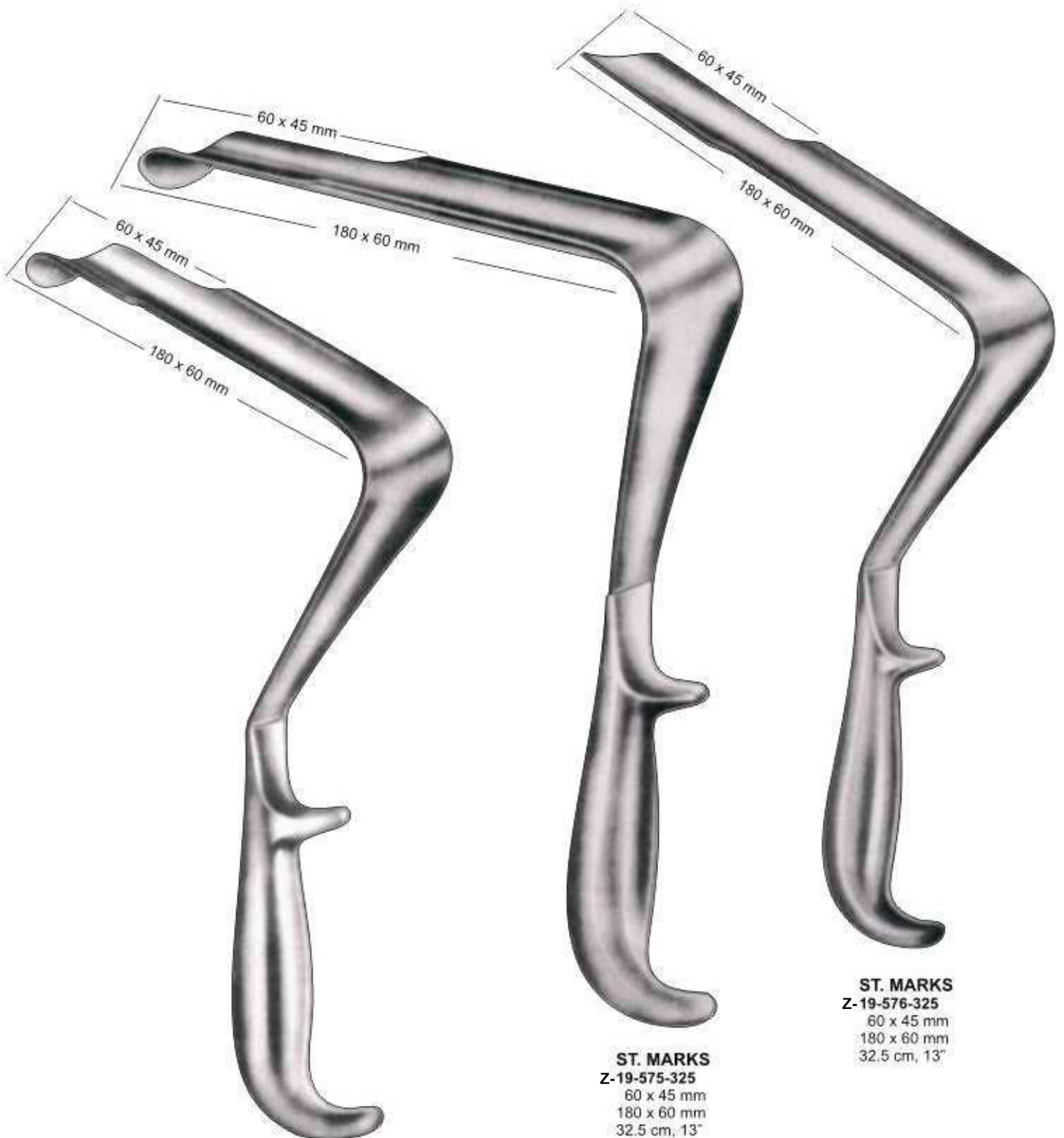

**ST. MARKS**  
**Z-19-574-290**  
 60 x 45 mm  
 180 x 60 mm  
 29 cm, 11 1/2"

**ST. MARKS**  
**Z-19-575-325**  
 60 x 45 mm  
 180 x 60 mm  
 32.5 cm, 13"

**ST. MARKS**  
**Z-19-576-325**  
 60 x 45 mm  
 180 x 60 mm  
 32.5 cm, 13"

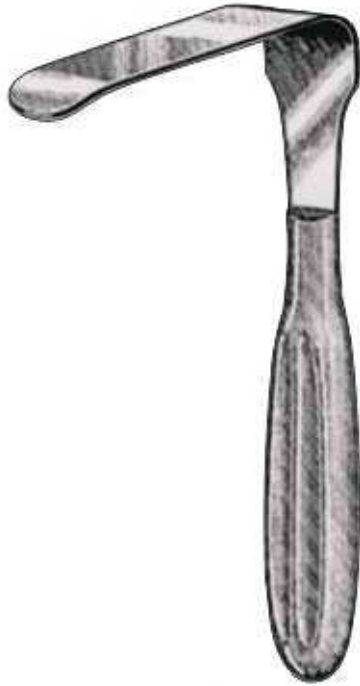

**BRANTLEY-TURNER  
RETRACTOR**  
Z-19-577-180  
100 x 30 mm  
18 cm, 7"



**PRYOR-PEAN  
RETRACTOR**  
Z-19-578-275  
115 x 25 mm  
27.5 cm, 10 3/4"



**ALLISON**  
Z-19-579-300 30 cm, 12" 40 mm  
Z-19-580-320 32 cm, 12 1/4" 54 mm  
lungenspatel Spatulas



**ALLISON**  
Z-19-581-300 132 mm  
30 cm, 12"



**KOERTE**  
Z-19-582-280  
120 x 45 mm  
28 cm 11"



**KUEMMEL**  
Z-19-583-280  
100 x 45 mm  
28 cm, 11"



**YOUNG**  
Z-19-584-220  
22 cm, 8 3/4"



**YOUNG**  
Z-19-585-215  
21.5 cm, 8 1/2"  
Prostatic Retractors



**YOUNG**  
Z-19-586-215  
21.5 cm, 8 1/2"



**YOUNG**  
Z-19-587-220  
22 cm, 8 3/4"



**COOLEY**  
**Z-19-588-250**  
25 cm, 10"  
Right



**COOLEY**  
**Z-19-589-270**  
27 cm, 10 1/2"  
Left



**COOLEY**  
**Z-19-590-250**  
25 cm, 10"  
Right - Serrated



**SAWYER  
RETRACTORS**

- Z-19-591-230**  
Small Blade 70 mm x 19 mm wide  
23 cm 9"
- Z-19-592-250**  
Medium Blade 82 mm x 29 mm wide  
25 cm 10"



**FERGUSON-MOON  
RECTAL RETRACTORS**

- Z-19-593-230**  
Blade 60 mm x 24 mm wide  
23 cm 9"
- Z-19-594-250**  
Blade 75 mm x 35 mm wide  
25 cm 10"



**HILL FERGUSON  
RECTAL RETRACTORS**

- Z-19-595-230**  
Blade 64 mm x 24 mm wide  
23 cm 9"
- Z-19-596-230**  
Blade 76 mm x 32 mm wide  
23 cm 9"
- Z-19-597-250**  
Blade 76 mm x 35 mm wide  
25 cm 10"



- Z-19-598-240** 24 cm 9 1/2"  
50 x 40 mm wide
- Z-19-599-240** 24 cm 9 1/2"  
65 x 50 mm wide
- Z-19-600-250** 25 cm 10"  
75 x 65 mm wide
- Z-19-601-250** 25 cm 10"  
90 x 75 mm wide

**KELLY  
RETRACTORS**



**RICHARDSON  
RETRACTORS**



- Z-19-602-240** 24 cm 9 1/2"  
Blade 25 x 20 mm wide



- Z-19-603-240** 24 cm 9 1/2"  
Blade 36 x 28 mm wide

- Z-19-604-240** 24 cm 9 1/2"  
Blade 44 x 28 mm wide



- Z-19-605-250** 25 cm 10"  
Blade 52 x 22 mm wide

- Z-19-606-250** 25 cm 10"  
Blade 70 x 52 mm wide

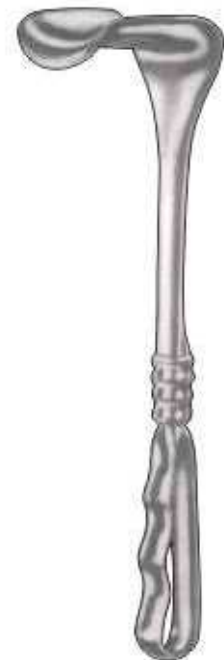

**KELLY  
Z-19-607-250**  
55 x 50 mm  
25 cm, 10"

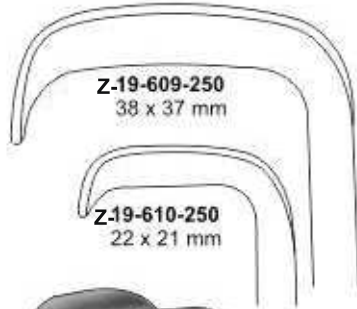

**RICHARDSON-EASTMAN**  
Z-19-608-250  
25.0 cm 10", Set of 2 piece

**RICHARDSON**  
24.0 cm 9.5"

**RICHARDSON**  
Z-19-614-240  
24.0 cm 9.5"

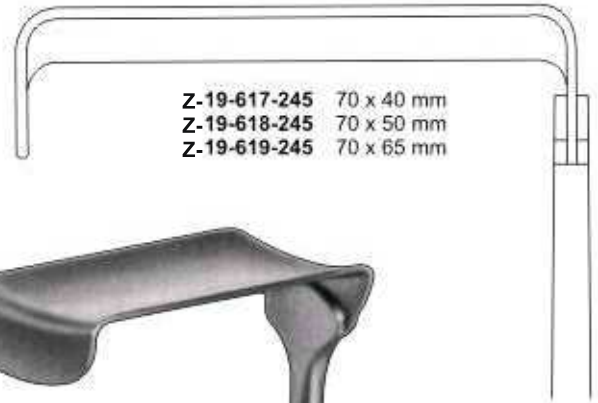
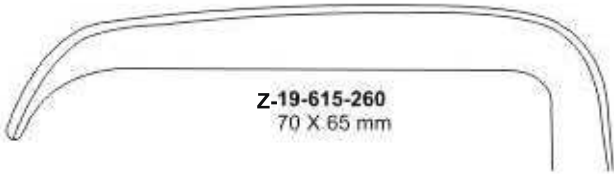

**KELLY**  
26.0 cm 10 ¼"



**MORRIS**  
24.5 cm 9 ¾"





**MAYO ABDOMINAL  
RETRACTOR**

Z-19-620-001  
25 cm, 10"  
69 x 254 mm



**C.W. MAYO ABDOMINAL  
RETRACTOR**

Z-19-621-257 25.7 cm, 10 1/4"  
Blade 70 mm wide.  
Z-19-622-248 24.8 cm, 10"  
Blade 79 mm wide.



**BREWSTER RETRACTOR**

Z-19-623-240 Style A 19 x 38 mm  
Z-19-624-240 Style B 45 x 25 mm  
Z-19-625-240 Style C 50 x 45 mm  
Z-19-626-240 Style D 57 x 45 mm  
Z-19-627-240 Style E 64 x 45 mm  
24 cm, 9 1/2"



**KELLY RETRACTOR**

Z-19-628-230 23 cm, 9" 38 x 50 mm  
Z-19-629-240 24 cm, 9 1/2" 50 x 64 mm  
Z-19-630-250 25 cm, 10" 64 x 76 mm  
Z-19-631-260 26 cm, 10 1/4" 69 x 82 mm



**SIMS-KELLY RETRACTOR**

Z-19-632-240 57 x 25 mm  
Z-19-633-240 69 x 45 mm  
Z-19-634-240 76 x 38 mm  
24 cm, 9 1/2"



**ZAIKIND LUNG RETRACTOR**

Z-19-635-250 Malleable 50 x 305 mm  
Z-19-636-250 Malleable 76 x 305 mm  
25 cm, 10"



**DE LEE CORNER RETRACTORS**  
**Z-19-637-235** 23.5 cm, 9 1/4"  
 Right Blade 70 x 51 mm wide  
**Z-19-638-235** 23.5 cm, 9 1/4"  
 Left Blade 70 x 51 mm wide

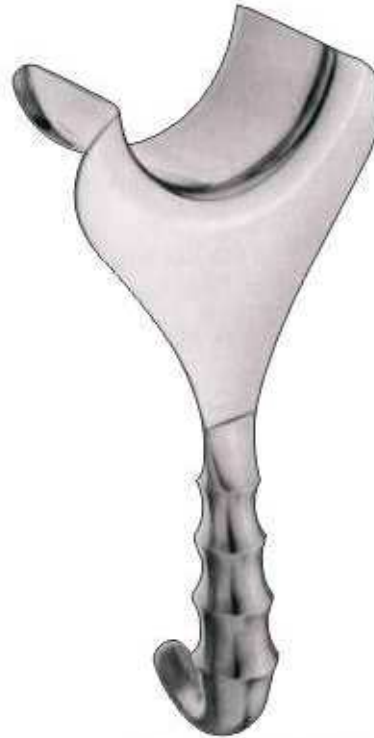

**DE LEE UNIVERSAL RETRACTORS**  
**Z-19-639-235** 23.5 cm, 9 1/4"  
 Blade 70 mm x 51 mm wide



**TAUBER VAGINAL SPATULA**  
**Z-19-640-235** 23.5 cm, 9 1/4"  
 Blade 89 x 35 mm wide



**HEANY**  
**Z-19-641-270** 27 cm, 10 1/2", 45 x 25 mm  
**Z-19-642-270** 27 cm, 10 1/2", 57 x 33 mm  
**Z-19-643-270** 27 cm, 10 1/2", 80 x 33 mm



**Z-19-644-250**  
25 cm, 10"  
35 x 8 mm

**Z-19-645-265**  
26.5 cm, 10 1/2"  
60 x 12 mm

**Z-19-646-275**  
27.5 cm, 10 3/4"  
75 x 12 mm

**Z-19-647-285**  
28.5 cm, 11 1/4"  
85 x 20 mm

**Z-19-648-305**  
30.5 cm, 12"  
100 x 25 mm

**ZENKER**

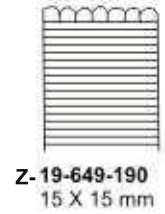

**Z-19-649-190**  
15 X 15 mm



**Z-19-650-190**  
15 X 23 mm

**CRAWFORD**  
19 cm, 7 1/2"



**Z-19-651-275**  
20 mm



**Z-19-652-275**  
30 mm



**Z-19-653-275**  
40 mm

**KADER**  
27.5 cm, 10 3/4"



**MALLEABLE**

Item	Description	Tip
19-654-200	20 cm, 8"	12 mm
19-655-200	20 cm, 8"	17 mm
19-656-200	20 cm, 8"	25 mm
19-657-330	33 cm, 13"	25 mm
19-658-330	33 cm, 13"	32 mm
19-659-330	33 cm, 13"	40 mm
19-660-330	33 cm, 13"	50 mm



**RIBBON  
RETRACTOR**  
Z-19-661-200  
20 cm, 8"  
Width 4 cm



**RIBBON  
RETRACTOR**  
Z-19-662-200  
20 cm, 8"  
Width 2.5 cm



**TUFFIER / HABERER**  
malleable  
Z-19-663-200 17 x 25 mm 20 cm, 8"  
Z-19-664-280 25 x 30 mm 28 cm, 11"  
Z-19-665-300 37 x 45 mm 30 cm, 11 3/4"



**REVERDIN**  
Z-19-666-280  
28 cm, 11"  
46 x 60 mm



**REVERDIN**  
Z-19-667-290  
29 cm, 11 1/2"



**BLOOD SCOOP**  
Z-19-668-150  
15 cm, 6"



**HEISS**  
Z-19-669-100 10 cm, 4"  
Sharp 4:4  
Z-19-670-100 10 cm, 4"  
Blunt 4:4



**FINSEN**  
Z-19-671-070 7 cm, 2 3/4"  
3 x 4 teeth, sharp  
Z-19-672-070 7 cm, 2 3/4"  
3 x 4 teeth, Blunt



**FINSEN**  
Z-19-673-050 5 cm, 2"  
2 x 3 teeth sharp/blunt  
Z-19-674-070 7 cm, 2 3/4"  
2 x 3 teeth sharp/blunt



**BUCKLEY**  
Z-19-675-060  
6 cm, 2 1/2"

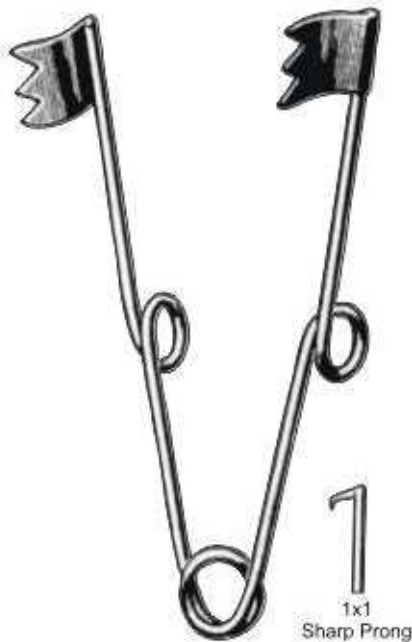

**WIRE RETAINING  
RETRACTOR**  
Z-19-676-085 8.5 cm, 3 1/2" 3 x 3 Prong  
Z-19-677-085 8.5 cm, 3 1/2" 1 x 1 Prong Sharp



**ALM**  
Z-19-678-070 7 cm, 2 3/4"  
4 x 4 teeth sharp/blunt  
Z-19-679-070 10 cm, 4"  
4 x 4 teeth sharp/blunt



**JANSEN**  
Z-19-680-100 10 cm, 4"  
Sharp 3:3  
Z-19-681-100 10 cm, 4"  
Blunt 3:3



**WALTON**  
Z-19-682-180 Sharp  
Z-19-683-180 Blunt  
18 cm, 7"



**KNIGHTON**  
Z-19-684-180 Sharp  
Z-19-685-180 Blunt  
18 cm, 7"



**RICHTER**  
Z-19-686-165  
16.5 cm, 6 1/2"



**SCALP-CONTOUR**  
Z-19-687-140 Sharp  
Z-19-688-140 Blunt  
14 cm, 5 1/2"



**HENLEY**

**Z-19-689-160**  
16 cm, 6 1/4"  
3 : 4 mm  
blunt

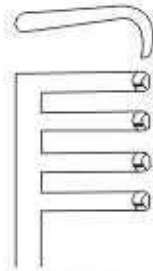

**Z-19-690-160**  
16 cm, 6 1/4"  
3 : 4 mm  
sharp

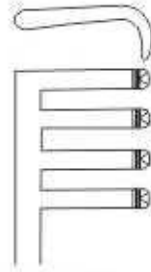

**HOUZEL**  
**Z-19-691-290**  
29 cm, 11 1/2"



**HORIZONTAL  
RETRACTOR**  
**Z-19-692-330**  
33 cm, 13"



**MOLLISON**  
**Z-19-693-150**  
15 cm, 6"  
sharp



**DARLING**

**Z-19-694-180** 18 cm, 7"  
40 x 76/25 x 54 mm  
**Z-19-695-180** 18 cm, 7"  
25 x 64/40 x 76 mm  
Laminectomy Retractors  
1 blade toothed

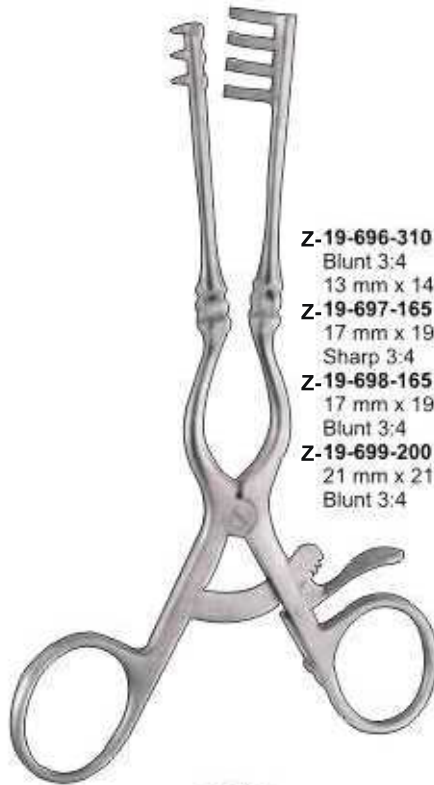

**CONE**

**Z-19-696-310** 31 cm, 12"  
Blunt 3:4  
13 mm x 14.5 mm  
**Z-19-697-165** 16.5 cm, 6 1/2"  
17 mm x 19 mm  
Sharp 3:4  
**Z-19-698-165** 16.5 cm, 6 1/2"  
17 mm x 19 mm  
Blunt 3:4  
**Z-19-699-200** 20 cm, 8"  
21 mm x 210 mm  
Blunt 3:4



**GELPI-LOKTITE**

**Z-19-700-090** 9 cm, 3 1/2"  
6 mm Sharp  
**Z-19-701-110** 11 cm, 4 1/4"  
10 mm Sharp  
**Z-19-702-140** 14 cm, 5 1/2"  
10 mm Sharp  
**Z-19-703-190** 19 cm, 7 1/2"  
10 mm Sharp



**GELPI-LOKTITE**

**Z-19-704-180**  
18 cm, 7"



**MARKHAM/MEYERDING**

**Z-19-705-180**  
18 cm, 7" Blade 55 x 25 mm Left  
**Z-19-706-180**  
18 cm, 7" Blade 55 x 25 mm Right



**MILLIGAN**

**Z-19-707-130**  
18.5 mm x 20 mm  
Blunt, 3:3  
13 cm, 5"





**MISKIMON**  
Z-19-708-220 22 cm, 8 3/4"  
33 mm x 38 mm  
Sharp, 7:7



**MAYO-ADAMS**  
Z-19-709-170 17 cm, 6 3/4"  
2 x 2 teeth blunt



**TUEBINGER MODELL**  
Z-19-710-160  
16 cm, 6 1/4"



**PLESTER**  
Z-19-711-130  
13 cm, 5"  
2 x 2 teeth  
sharp/blunt



**PLESTER**

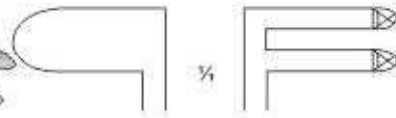

**Z-19-712-110**  
11 cm, 4 1/2"  
fig. 1 Blunt

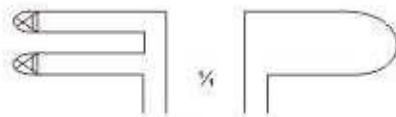

**Z-19-713-110**  
11 cm, 4 1/2"  
fig. 2 Blunt



**ADSON**



**Z-19-714-320**  
32 cm, 12 3/4"  
semi-sharp  
4 x 5 teeth  
26 mm



**ADSON-BABY**  
Z-19-715-160  
16 cm, 6 1/4" sharp  
3 x 4 teeth  
13 mm



**ADSON-BABY**  
Z-19-716-160  
16 cm, 6 1/4" blunt  
3 x 4 teeth  
13 mm



**SCHUHKNECHT**  
Z-19-717-140 Sharp  
Z-19-718-140 Blunt  
14 cm, 5 1/2"



**WULLSTEIN**  
Z-19-719-220 Z-19-722-220 10.5 cm, 4"  
Z-19-720-220 Z-19-723-220 13.0 cm, 5"  
Z-19-721-220 Z-19-724-220 16.0 cm, 6 1/4"  
Sharp Blunt



**TRAVERS**  
Z-19-725-210  
21 cm, 8 1/4"



**RIGHTBY**  
Z-19-726-180 35 x 20 mm  
Z-19-727-180 60 x 20 mm  
Z-19-728-180 65 x 15 mm  
18 cm, 7"



**MISKIMON**  
Z-19-729-220 Sharp  
Z-19-730-220 Blunt  
22 cm, 8 3/4"



**WEITLANER**  
Sharp  
Z-19-731-130  
13.0 cm 5.25"



**WEITLANER**  
Sharp  
Z-19-732-165  
16.5 cm 6.5"

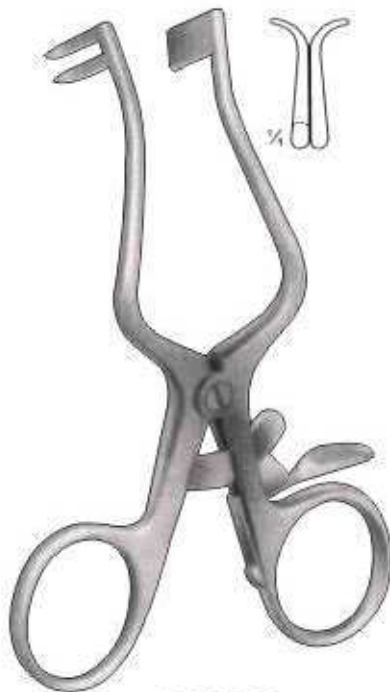

**PLESTER**  
Blunt  
Z-19-733-110  
11.0 cm 4.25"

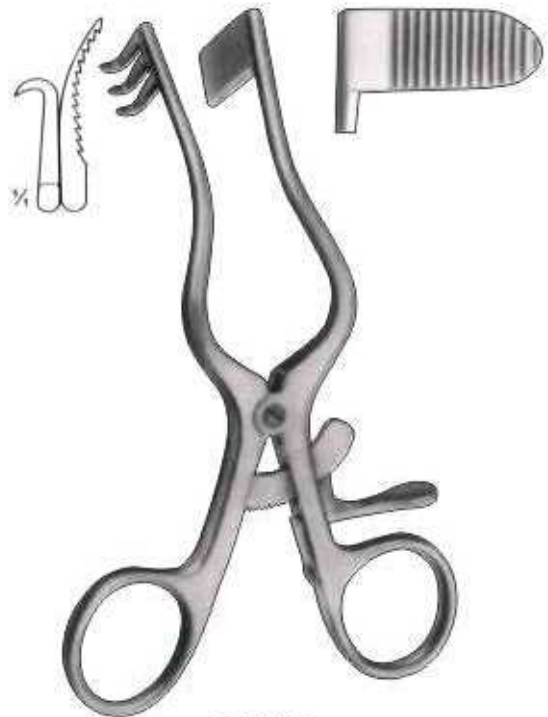

**PERKINS**  
Z-19-734-130  
13.0 cm 5.25"

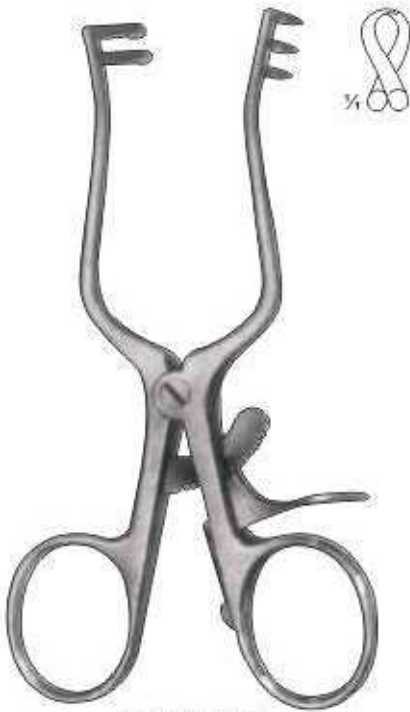

**WEITLANER**  
Z-19-735-110  
Sharp  
11.0 cm

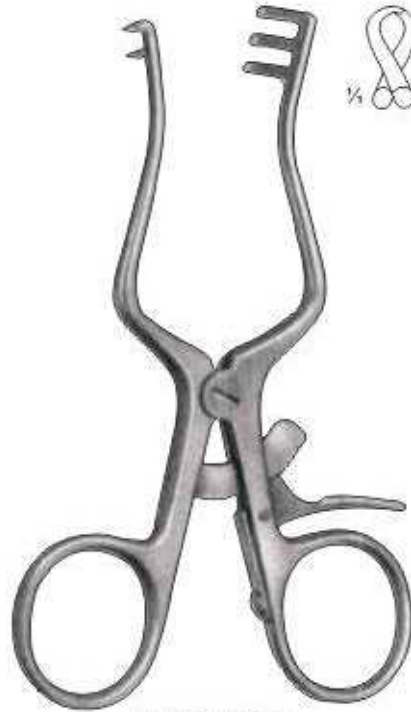

**WEITLANER**  
Z-19-736-110  
Semi-Sharp  
11.0 cm



**WEITLANER**  
Z-19-737-110  
Blunt  
11.0 cm

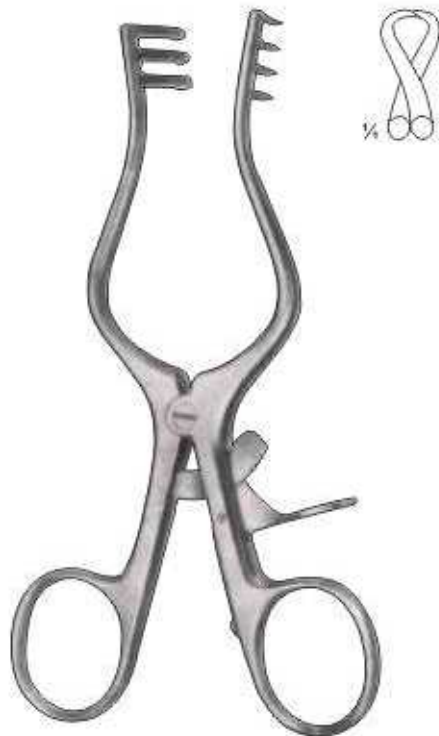

**WEITLANER**  
Z-19-738-130  
Sharp  
13.0 cm



**WEITLANER**  
Z-19-739-130  
Semi-Sharp  
13.0 cm



**WEITLANER**  
Z-19-740-130  
Blunt  
13.0 cm



**WILLIGER**  
Z-19-741-120  
12.0 cm, 5"

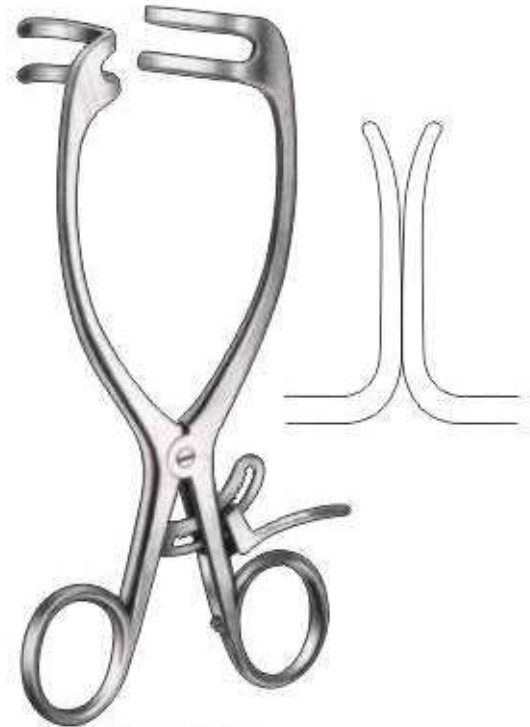

**MAYO-ADAMS**  
Z-19-742-165  
16.5 cm 6 1/2"



**ADSON-BABY**  
Z-19-743-140  
14.0 cm 5 1/2"  
Blunt



**MOLLISON**  
19-744-155  
15.5 cm 6"  
Sharp

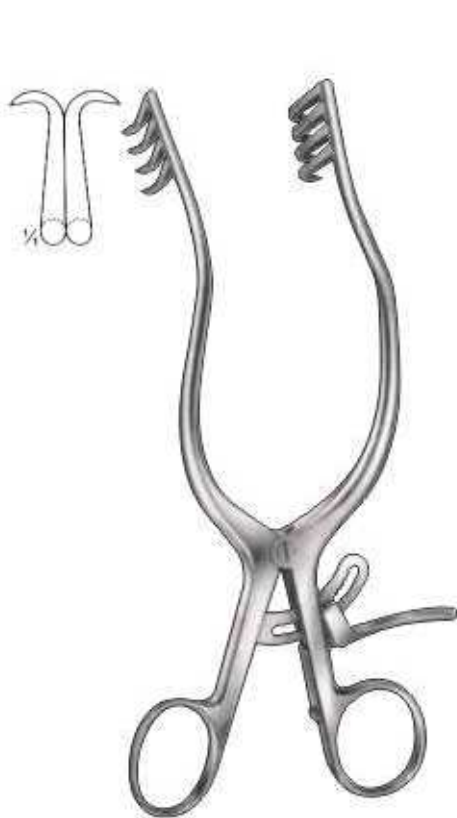

**ANDERSON-ADSON**  
Z-19-745-190  
19.0 cm 7 1/2"  
Sharp

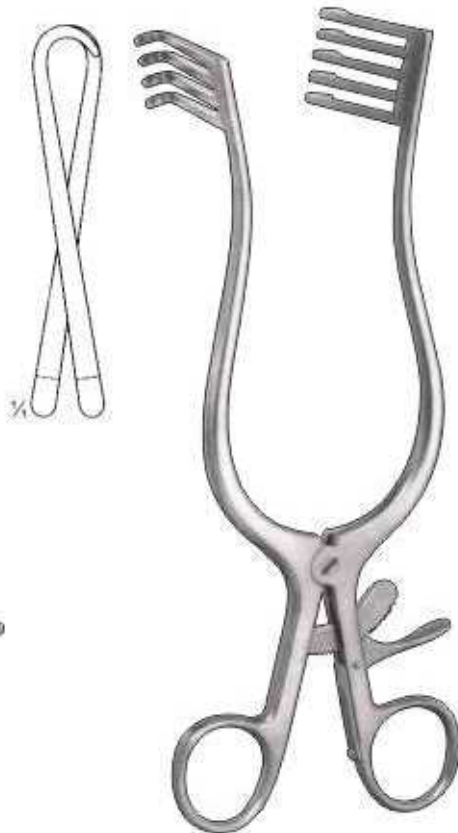

**NORFOLK & NORWICH**  
Z-19-746-220  
22.0 cm 8 3/4"  
Blunt

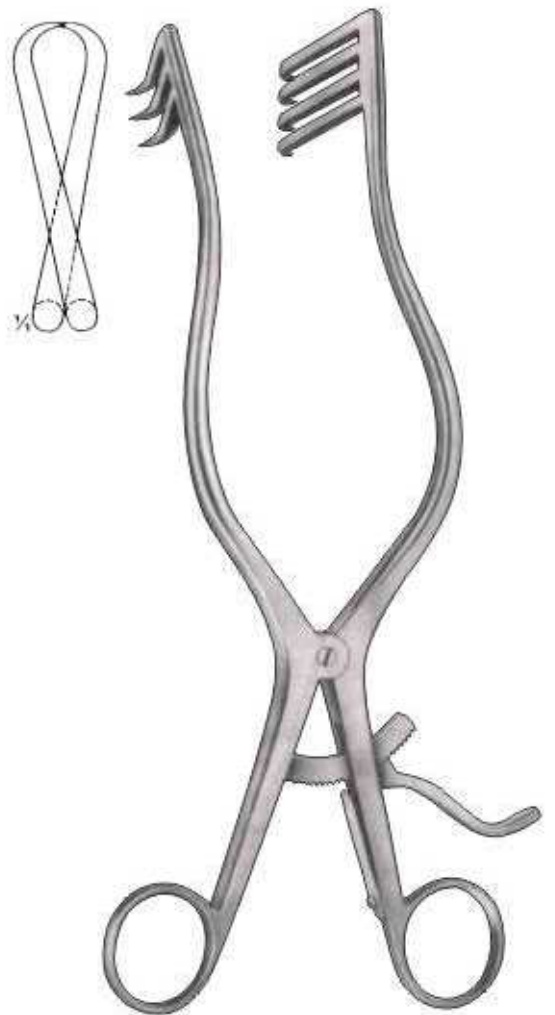

**ADSON**  
Z-19-747-265  
26.5 cm 10 1/4"  
Sharp

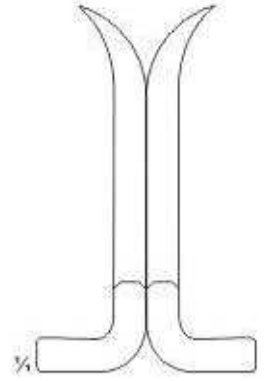
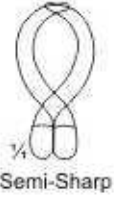

**BECKMANN-ADSON**  
Z-19-748-310  
31 cm, 12 1/4"  
Sharp



**BECKMANN-ADSON**  
Z-19-749-310  
31 cm, 12 1/4"  
Semi-Sharp



**ADSON**  
Z-19-750-320  
32 cm, 12 1/2"  
Semi-Sharp



**BECKMANN-EATON**  
Z-19-751-320  
32 cm, 12 1/2"  
Sharp



**JOLL (Friedman)**  
**Z-19-752-155**  
Thyroid- and Vaginal Retractor  
15.5 cm, 6 1/2"



**JACKSON BURROWS**  
**Retractor**  
**Z-19-753-185**  
blunt  
18.5 cm, 7"



**GELPI**  
Vaginal Retractor  
**Z-19-754-135**  
13.5 cm, 5"



**GELPI**  
Skin- and Vaginal Retractor  
**Z-19-755-175**  
17.5 cm, 7"

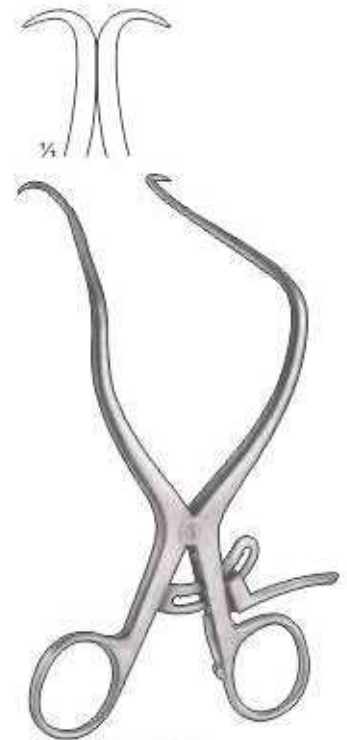

**DE BAKEY**  
Femur Retractor  
**Z-19-756-145**  
14.5 cm, 4 1/2"





CLOWARD modif.  
**Z-19-757-000**  
Spreader Only



**Z-19-758-000**



**Z-19-759-000**

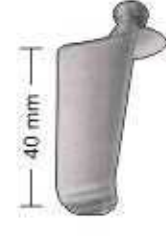

**Z-19-760-000**



**Z-19-761-000**

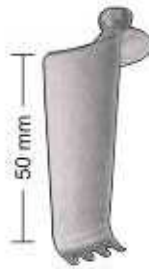

**Z-19-762-000**



**Z-19-763-000**



**Z-19-764-000**



**Z-19-765-000**



**Z-19-766-000**



**Z-19-767-000**

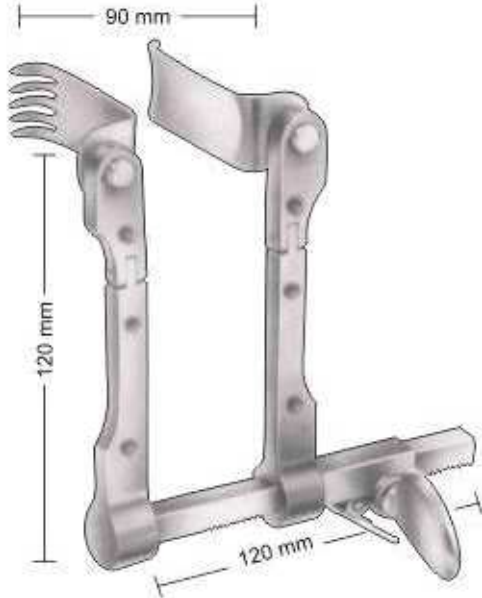

**CASPAR**  
**Z-19-768-000**  
Retractor, adjustable,  
consisting of: 5 medial  
blades, 5 Lateral blades.

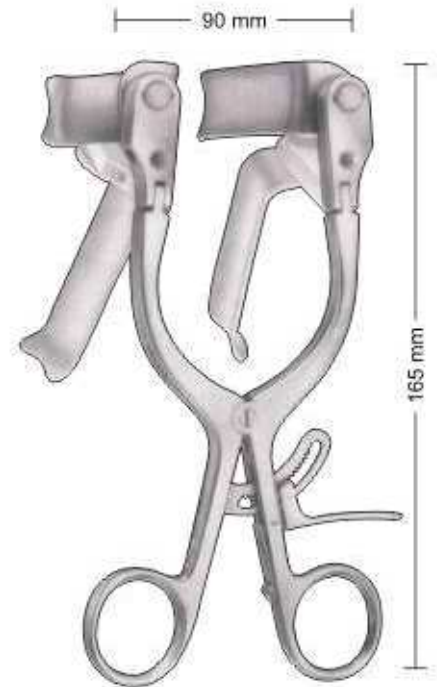

**CASPAR**  
**Z-19-769-000**  
Counter retractor, adjustable,  
consisting of: 5 medial blades,  
5 lateral blades.



**Z-19-770-000** 40 x 23 mm  
**Z-19-771-000** 45 x 23 mm  
**Z-19-772-000** 50 x 23 mm  
**Z-19-773-000** 55 x 23 mm  
**Z-19-774-000** 60 x 23 mm  
Medial blades



**Z-19-775-000** 40 x 23 mm  
**Z-19-776-000** 45 x 23 mm  
**Z-19-777-000** 50 x 23 mm  
**Z-19-778-000** 55 x 23 mm  
**Z-19-779-000** 60 x 23 mm  
Lateral blades



**Z-19-780-000** 45 x 23 mm  
**Z-19-781-000** 50 x 23 mm  
**Z-19-782-000** 55 x 23 mm  
**Z-19-783-000** 60 x 23 mm  
**Z-19-784-000** 60 x 23 mm  
Blunt blades



**Z-19-785-000** 50 x 25 mm  
**Z-19-786-000** 55 x 25 mm  
Blunt blades,  
for harvesting of the  
fusion graft from the  
iliac crest

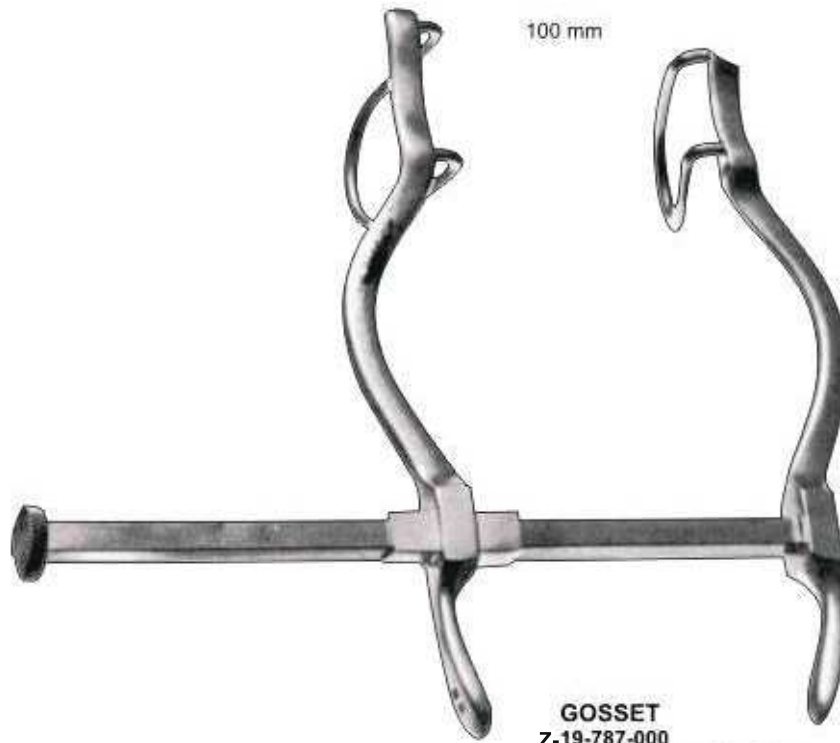

**GOSSET**  
**Z-19-787-000**  
Center Blades 40 x 30 mm

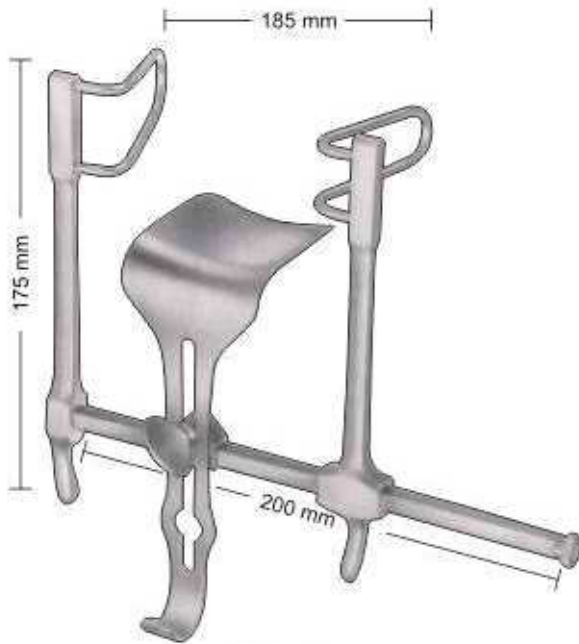

**GOSSET**  
**Z-19-788-000**  
Lateral Blades 58 mm deep  
Center blade 59 x 57 mm

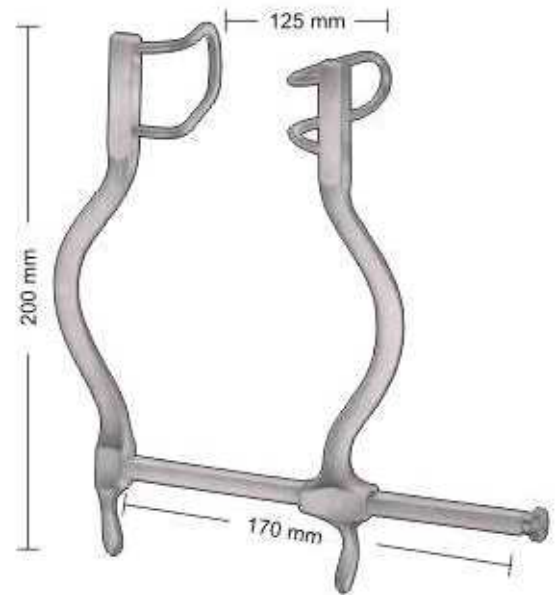

**GOSSET**  
**Z-19-789-000**  
Blades: 55mm deep

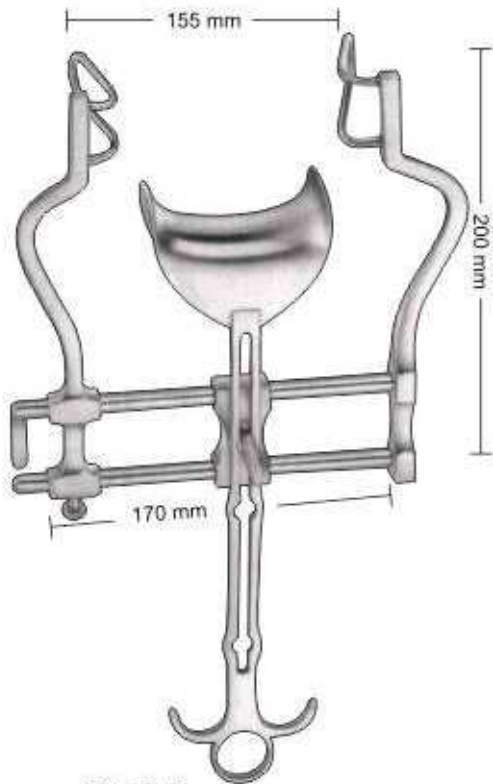

**BALFOUR**  
**Z-19-790-000**  
Lateral blades 60 mm deep  
Center blade 47 x 80 mm

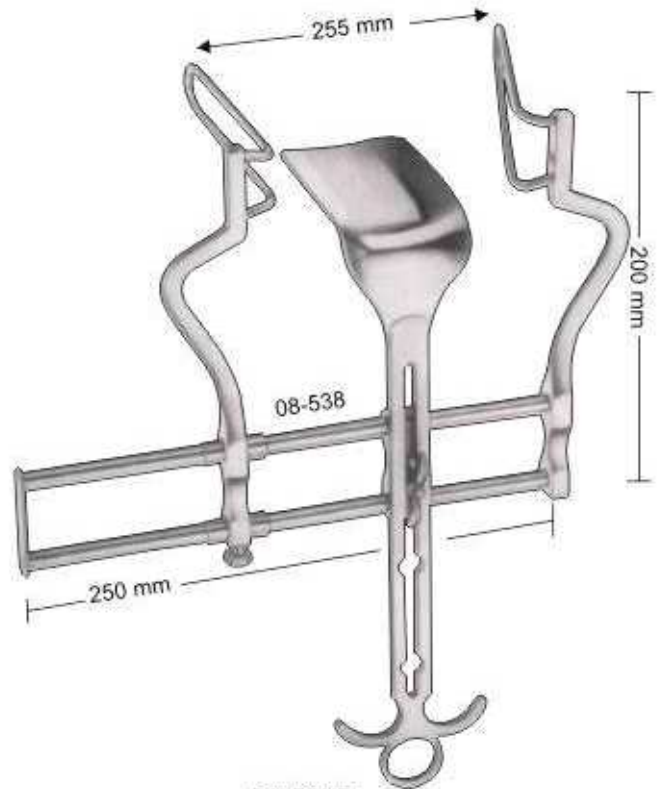

**BALFOUR**  
**Z-19-791-000**  
Lateral blades 105 mm deep  
Center blade 107 x 59 mm



**Z-19-792-000**  
Center blade only  
54 x 80 mm

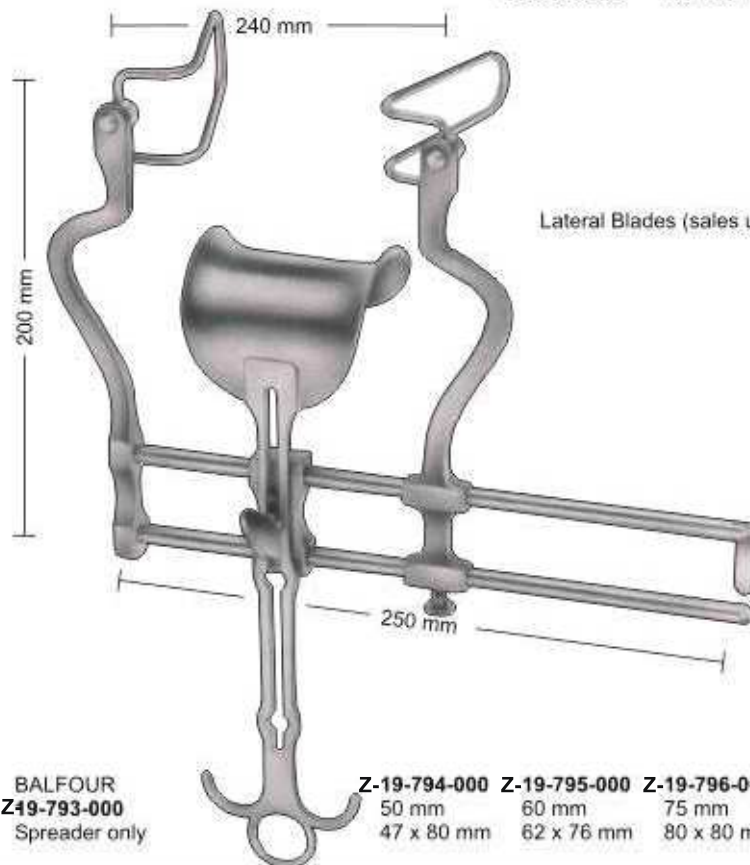

**BALFOUR**  
**Z-19-793-000**  
Spreader only

Lateral Blades (sales unit of blades in pairs)

<b>Z-19-794-000</b>	<b>Z-19-795-000</b>	<b>Z-19-796-000</b>	<b>Z-19-797-000</b>
50 mm	60 mm	75 mm	90 mm
47 x 80 mm	62 x 76 mm	80 x 80 mm	80 x 80 mm

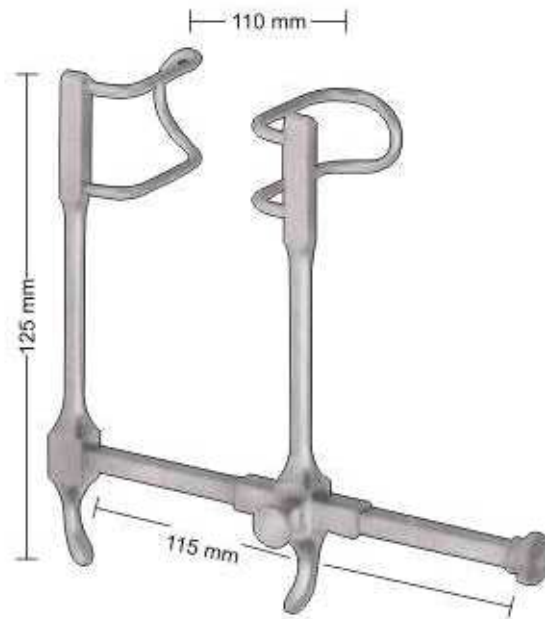

**GOSSET**  
Z-19-798-000  
Blades: 38 mm deep

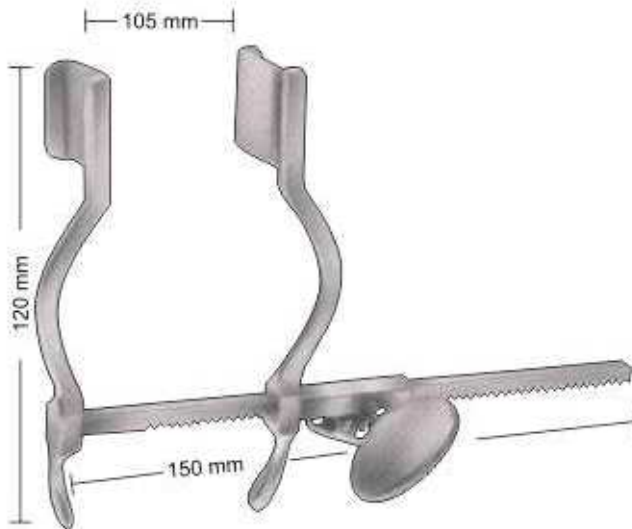

**HERTZLER**  
Z-19-799-000  
Blades 20 x 25 mm

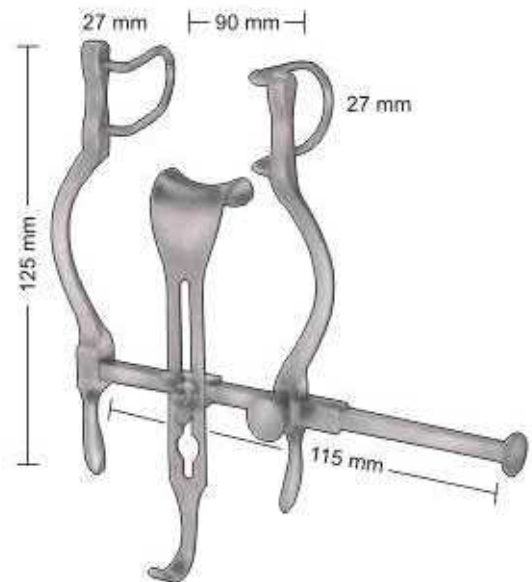

**BALFOUR-BABY**  
Z-19-800-000  
Lateral Blades 27 mm deep  
Center blade 21 x 24 mm



**O'SULLIVAN/O'CONNOR**

Z-19-801-000 (Set includes frame & 3 blades)  
Z-19-802-000 Frame Only (not pictured)



**Z-19-803-000**  
Single Retractor Blade  
110 x 70 mm



**Z-19-804-000**  
Set of 2 Retractor Blade  
80 x 45 mm



**Z-19-805-000**  
Center Blade  
45 x 80 mm  
70 x 85 mm

Sizes of These Blades to  
Same as about Blades.



**Z-19-806-000**  
Center Blade  
100 x 60 mm

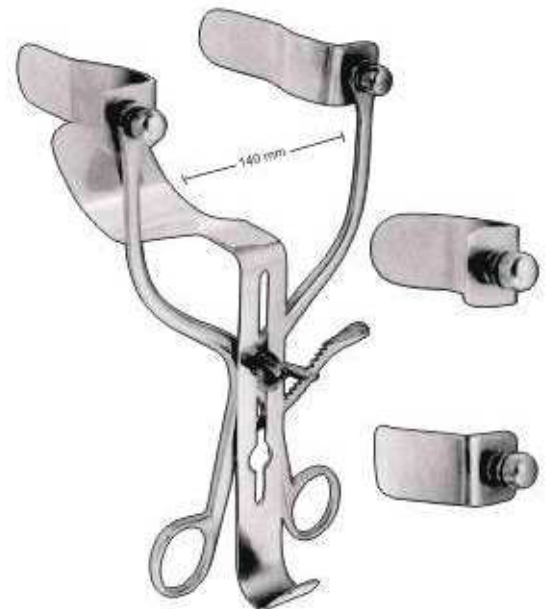

**COLLIN**

Z-19-807-250 Complete  
Z-19-808-001 Spreader only  
Z-19-809-002 Blades 55 x 25 mm  
Z-19-810-003 Blades 80 x 25 mm  
Z-19-811-004 Center Blade  
115 x 45 mm

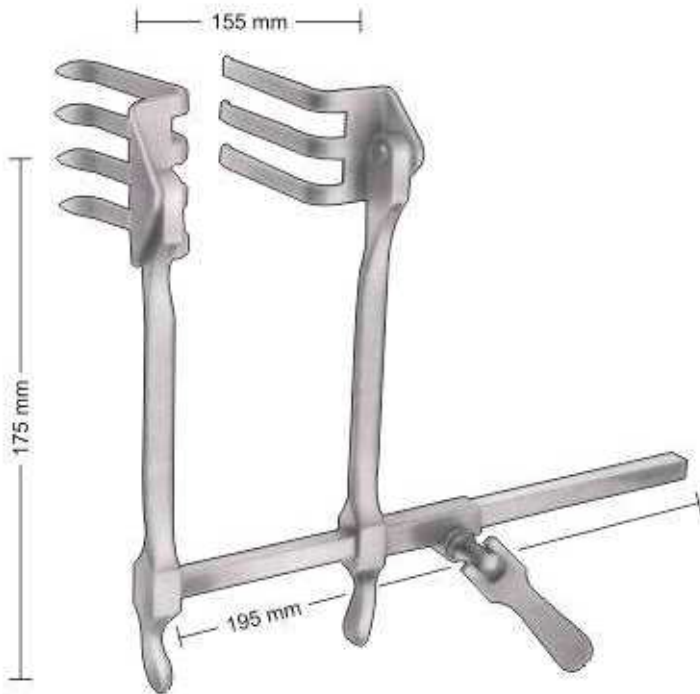

**SCOVILLE-RICHTER**

**Z-19-812-000** Complete with 1 pair blades.

**Z-19-813-000** Frame only.

The Retractor bar and shanks may be easily rotates 180 when blades are in situ.



**Z-19-814-000**  
62 x 52 mm



62 x 37 mm



**Z-19-815-000**  
47 x 51 mm



**Z-19-816-000**  
30 x 40 mm



**Z-19-817-000**  
37 x 62 mm



**COLLIN**  
Z-19-818-200 20 cm, 8"  
complete with 2 lateral  
blades and central blade

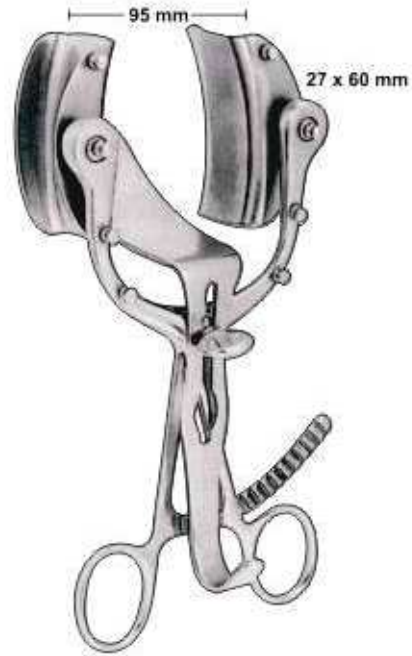

**LEGUEU**  
Z-19-819-170  
17 cm, 6 3/4"



**DOYEN**  
Z-19-820-280 48 mm x 90 mm  
Z-19-821-280 48 mm x 105 mm  
Z-19-822-280 48 mm x 120 mm  
Z-19-823-280 48 mm x 135 mm  
28 cm, 11"



**ROCHARD**  
Z-19-824-310 48 mm x 90 mm  
Z-19-825-310 48 mm x 105 mm  
Z-19-826-310 48 mm x 120 mm  
Z-19-827-310 48 mm x 135 mm  
Z-19-828-310 48 mm x 155 mm  
31 cm, 12"





**BABY-COLLIN**  
Z-19-829-000  
with 2 pair of blades

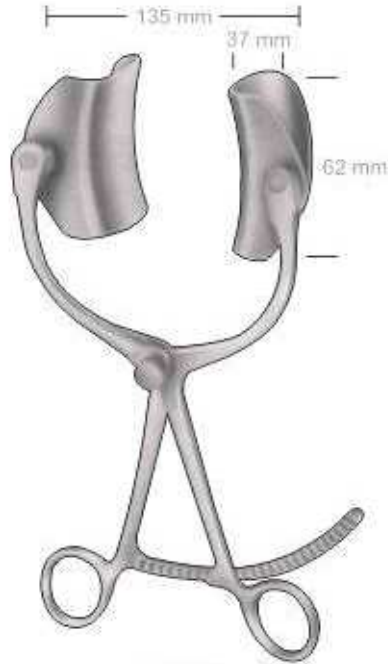

**COLLIN**  
Z-19-830-000  
complete

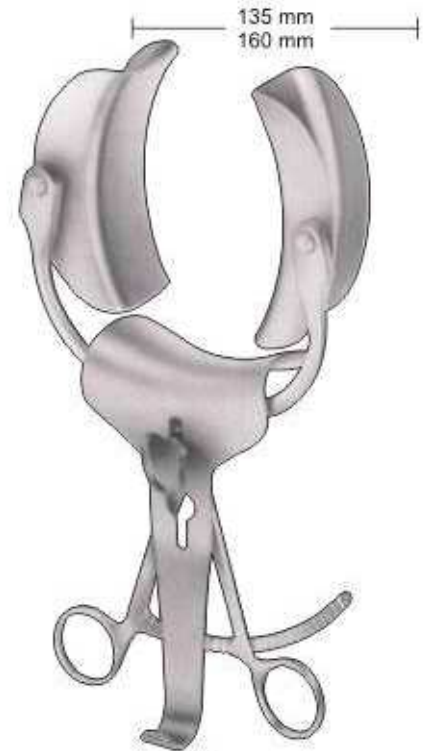

**COLLIN**  
19-831-000  
Spreader Only

Lateral blade	Z-19-832-000 37x62mm	Z-19-834-000 37x80mm	Z-19-836-000 37x98mm
Center blade	Z-19-833-000 54x55mm	Z-19-835-000 54x67mm	Z-19-837-000 52x76mm



**RICARD**  
Z-19-838-000 Complete  
Z-19-839-000 Spreader only  
Lateral blade Z-19-840-000 58x80mm  
Z-19-842-000 72x84mm  
Center blade Z-19-841-000 54x70mm  
Z-19-843-000 72x90mm

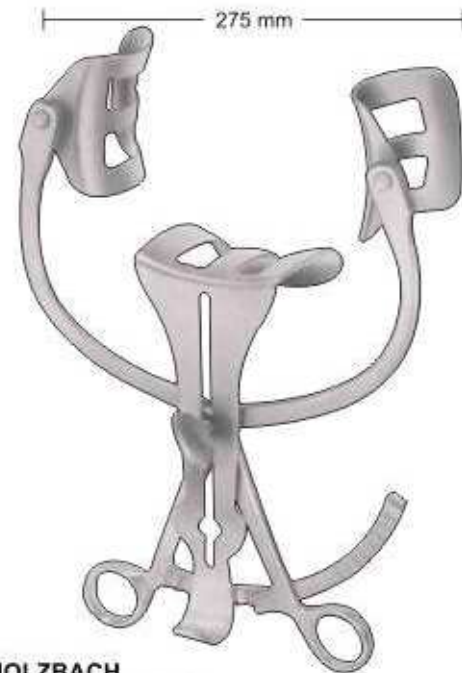

**HOLZBACH**  
Z-19-844-000 Complete  
Z-19-845-000 Spreader only  
Z-19-846-000 Lateral blade 59x80mm  
Z-19-847-000 Center blade 74x82mm

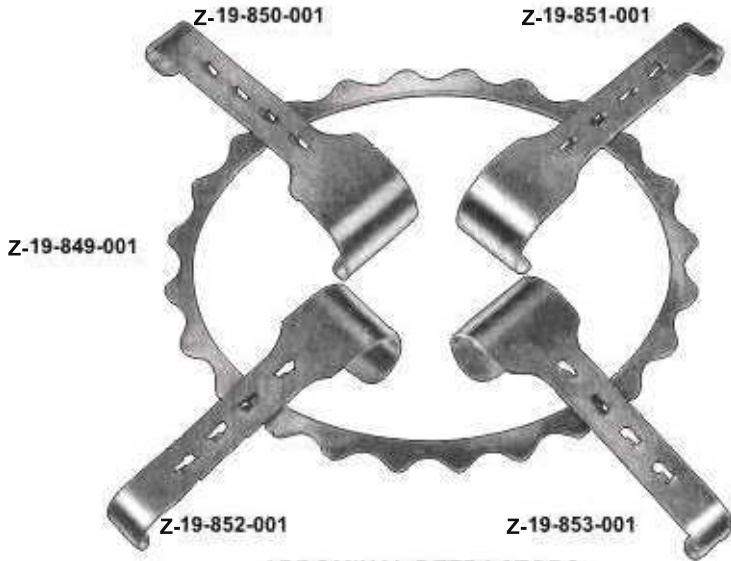

**ABDOMINAL RETRACTORS**  
for new-born and children

**DENIS-BROWNE**

**19-848-001** Complete with 4 blades

**Z-19-849-001** Frame 190 x 160 mm

**Z-19-850-001** 2 blades only 40 x 30 mm

**Z-19-851-001** 2 blades only 40 x 40 mm

**Z-19-852-001**  
Blades only 20 x 30 mm



**Z-19-853-001**  
Blades only 20 x 40 mm



**ABDOMINAL RETRACTORS**  
well suitable for gynaecologists

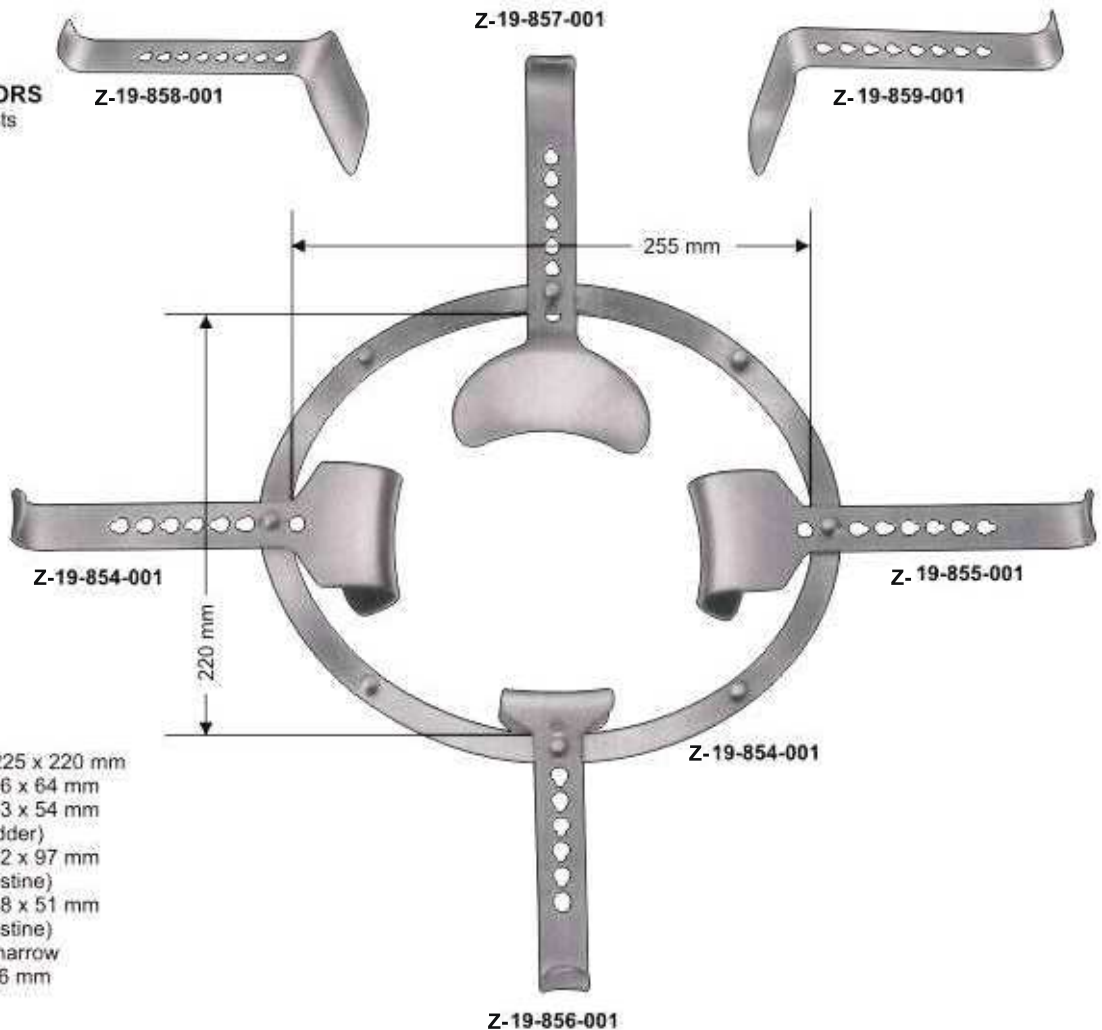

**SEMM**

consisting of:

- Z-19-854-001** 1 frame 225 x 220 mm
- Z-19-855-001** 2 blade 46 x 64 mm
- Z-19-856-001** 1 blade 53 x 54 mm  
(for bladder)
- Z-19-857-001** 1 blade 82 x 97 mm  
(for intestine)
- Z-19-858-001** 1 blade 98 x 51 mm  
(for intestine)
- Z-19-859-001** 1 blade, narrow  
107 x 36 mm

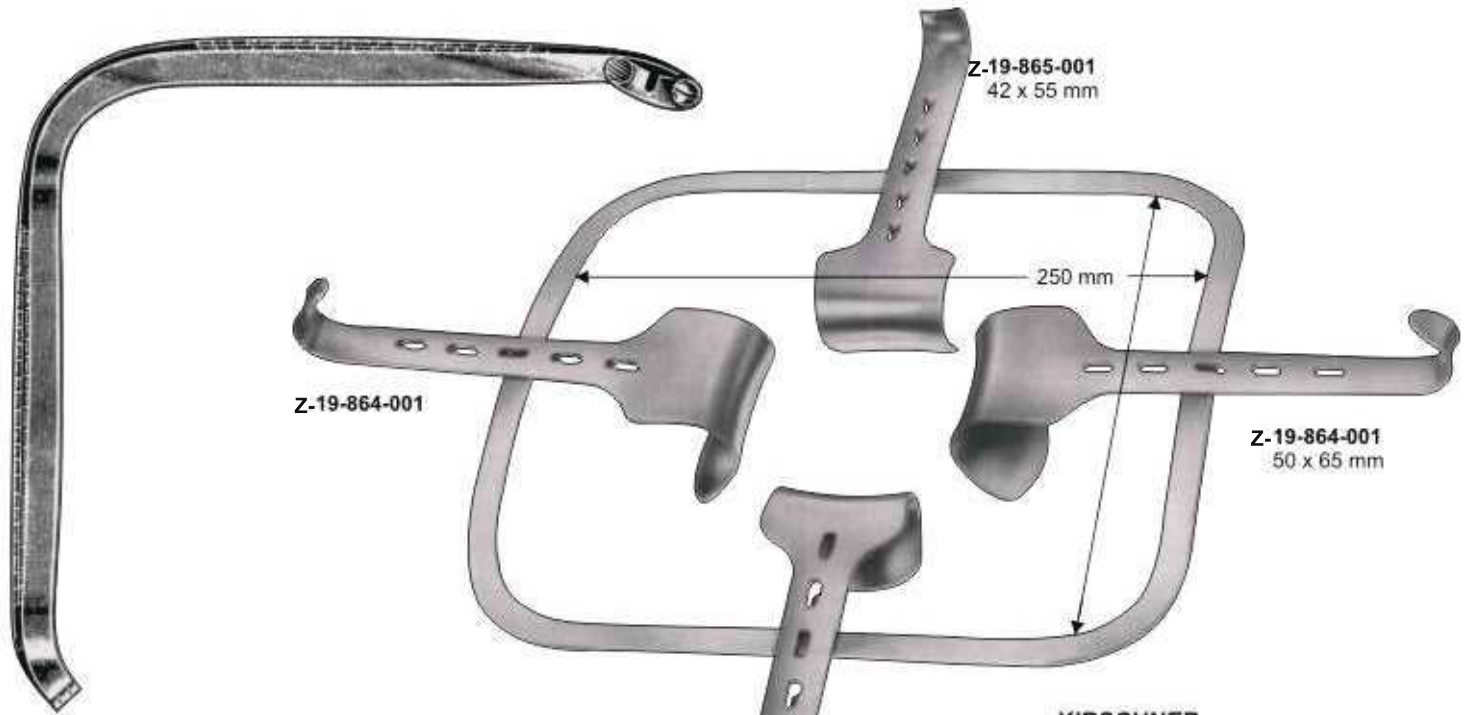

Z-19-864-001

Z-19-865-001  
42 x 55 mm

250 mm

Z-19-864-001  
50 x 65 mm

Z-19-865-001

**KIRSCHNER**  
Z-19-860-001  
with folding frame &  
2 blades of each 19-864-001 &  
Z-19-865-001

**KIRSCHNER**  
Z-19-861-001  
with vaulted fixed frame &  
2 blades of each 19-864-001 &  
Z-19-865-001

Z-19-862-001  
300 x 380 mm  
Frame only, over-sized

Z-19-863-001  
320 x 300 mm  
Frame only

Additional valves for corpulent persons



**KIRSCHNER**  
Z-19-866-001  
64 x 80 mm

**KIRSCHNER-BALFOUR**  
Z-19-867-001  
80 x 82 mm

**KIRSCHNER**  
Z-19-868-001 90 x 69 mm  
Z-19-869-001 92 x 95 mm  
Z-19-870-001 78 x 58 mm

**KIRSCHNER**  
Z-19-871-001 108 x 42 mm  
Z-19-872-001 91 x 55 mm  
Z-19-873-001 121 x 55 mm

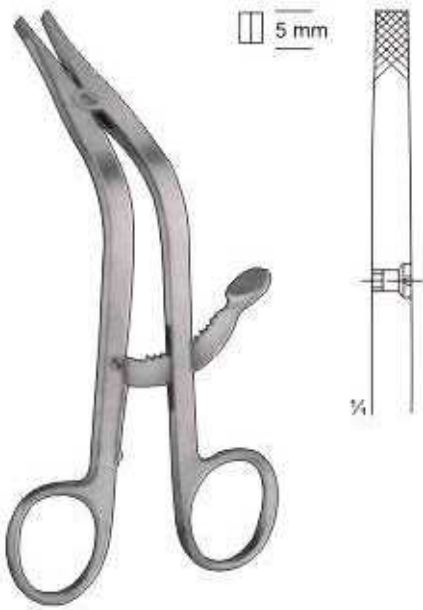

**CLOWARD**  
Z-19-874-155  
15.5 cm, 6"



**CLOWARD**  
Z-19-875-135  
13.5 cm, 5 1/4"

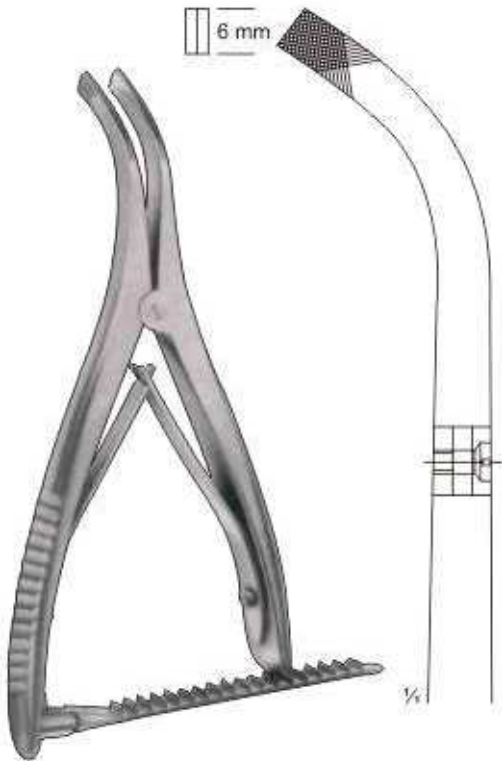

**INGE**  
Z-19-876-170  
17.0 cm, 6 3/4"

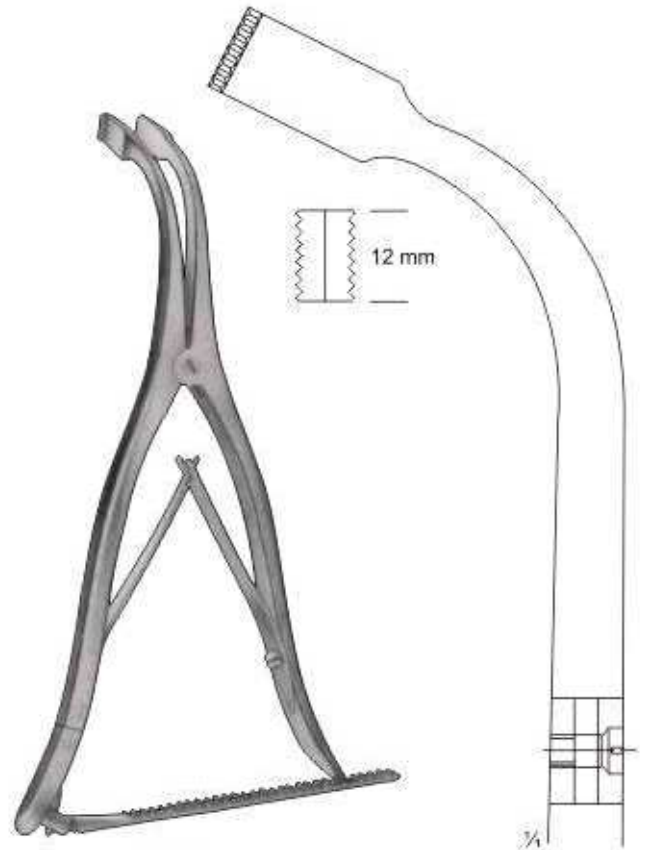

**INGE**  
Z-19-877-275  
27.5 cm, 10 3/4"

- **CARDIOVASCULAR FORCEPS**
- **RIB CONTRACTORS**

- **RIB SPREADERS**
- **RIB SHEARS & CHISELS**
- **VARICOSE VEIN SETS**



Thorax-cardiovasculaire  
 Thorax-cardiovascular

Torace-cardiovascolare  
 Torax-cardiovascular

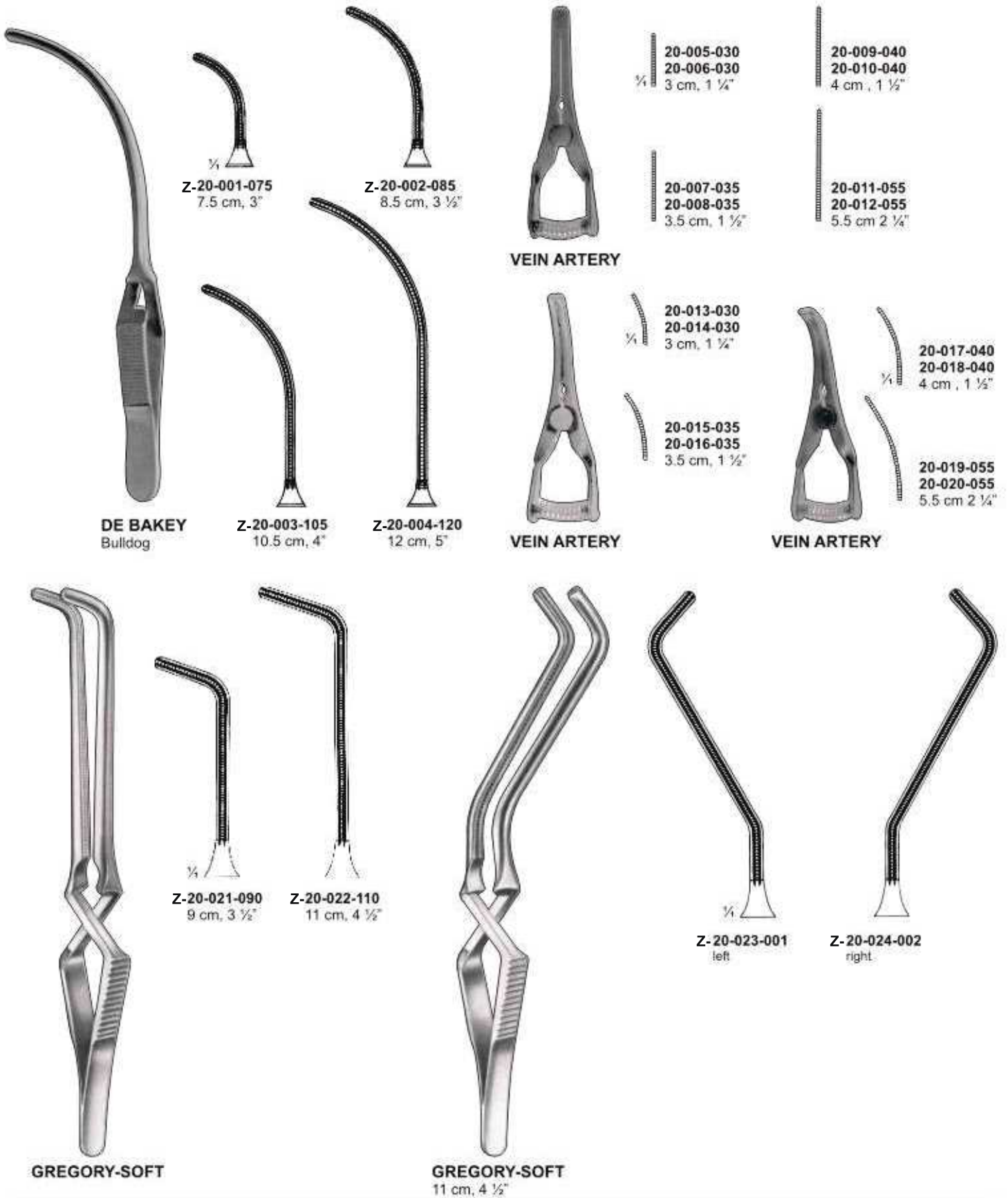



**DEBAKEY**



**Z-20-025-080**  
8 cm, 3 1/4"  
Jaw 20 mm  
Straight



**Z-20-026-090**  
9 cm, 3 1/2"  
Jaw 30 mm  
Straight



**Z-20-027-105**  
10.5 cm, 4"  
Jaw 45 mm  
Straight

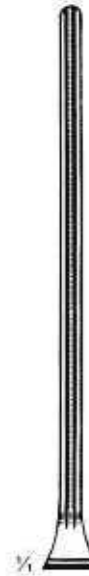

**Z-20-028-125**  
12.5 cm, 5"  
Jaw 68 mm  
Straight



**DEBAKEY**



**Z-20-029-075**  
7.5 cm, 3"  
Jaw 20 mm  
Curved



**Z-20-030-085**  
8.5 cm, 3 1/2"  
Jaw 30 mm  
Curved



**Z-20-031-095**  
9.5 cm, 3 3/4"  
Jaw 45 mm  
Curved



**Z-20-032-115**  
11.5 cm, 4 1/4"  
Jaw 68 mm  
Curved



**DIEFFENBACH**



**Z-20-033-038**  
3.8 cm, 1 1/2"



**Z-20-034-038**  
3.8 cm, 1 1/2"



**Z-20-035-051**  
5.1 cm, 2"



**Z-20-036-060**  
6 cm, 2 1/2"



**Z-20-037-060**  
6 cm, 2 1/2"



**Z-20-038-060**  
6 cm, 2 1/2"



**DIETRICH**



**Z-20-039-049**  
4.9 cm, 2"  
Jaw 8 mm  
Straight



**Z-20-040-053**  
5.3 cm, 2"  
Jaw 12 mm  
Straight



**Z-20-041-059**  
5.9 cm, 2 1/2"  
Jaw 20 mm  
Straight



**Z-20-042-043**  
4.3 cm, 1 3/4"  
Jaw 8 mm  
Curved



**Z-20-043-045**  
4.5 cm, 1 3/4"  
Jaw 12 mm  
Curved



**Z-20-044-050**  
5 cm, 2"  
Jaw 20 mm  
Curved



**BULLDOG CLAMP**



**Z-20-045-043**  
4.3 cm, 1 3/4"  
Jaw 13 mm  
Curved



**Z-20-046-049**  
4.9 cm, 2"  
Jaw 18 mm  
Curved



**Z-20-047-054**  
5.4 cm, 2 1/4"  
Jaw 20 mm  
Curved





**WICKHAM MINI**

**Z-20-048-049**  
4.9 cm, 2"  
Jaw 13 mm  
Straight



**Z-20-049-054**  
5.4 cm, 2 1/4"  
Jaw 18 mm  
Straight



**Z-20-050-061**  
6.1 cm, 2 1/2"  
Jaw 25 mm  
Straight



**Z-20-051-047**  
4.7 cm, 2"  
Jaw 13 mm  
Curved



**Z-20-052-051**  
5.1 cm, 2"  
Jaw 18 mm  
Curved



**Z-20-053-055**  
5.5 cm, 2 1/4"  
Jaw 25 mm  
Curved



**WICKHAM**  
**Z-20-054-240**  
24 cm, 9 1/2"



**DEBAKEY-DIETRICH**

**Z-20-055-047**  
4.7 cm, 2"  
Jaw 10 mm  
Straight



**Z-20-056-051**  
5.1 cm, 2"  
Jaw 14 mm  
Straight



**Z-20-057-057**  
5.7 cm, 2 1/4"  
Jaw 20 mm  
Straight



**Z-20-058-044**  
4.4 cm, 1 3/4"  
Jaw 10 mm  
Curved



**Z-20-059-046**  
4.6 cm, 1 3/4"  
Jaw 14 mm  
Curved



**Z-20-060-049**  
4.9 cm, 2"  
Jaw 20 mm  
Curved



**Z-20-061-054**  
5.4 cm, 2 1/4"  
Jaw 20 mm  
Curved



**JOHN-HOPKINS**  
**Z-20-062-245**  
24.5 cm, 9 3/4"

Thorax-cardiovasculaire  
Thorax-cardiovasculair

Torace-cardiovascolare  
Torax-cardiovascular



**OCHSNER**  
Z-20-063-235  
23.5 cm, 9 1/4"



**DIETRICH**  
Z-20-064-210  
21 cm, 8 1/4"

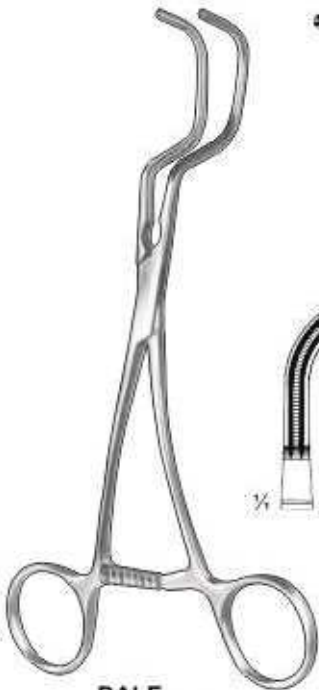

**DALE**  
Z-20-065-185  
18.5 cm, 7 1/4"

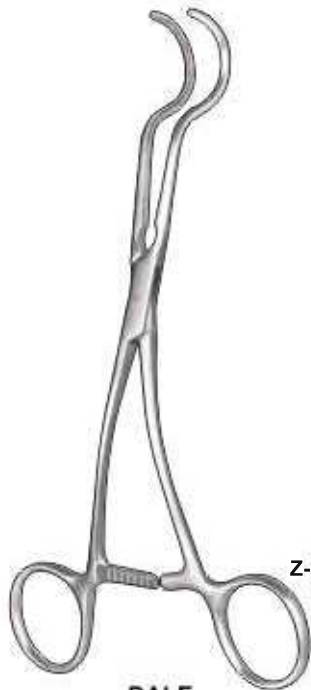

**DALE**

Z-20-066-170  
17 cm, 6 1/2"

Z-20-067-180  
18 cm, 7"

Z-20-068-185  
18.5 cm, 7 1/4"



**GREGORY**



**Z-20-069-140**  
14 cm, 5 1/2"



**Z-20-070-160**  
16 cm, 6 1/4"

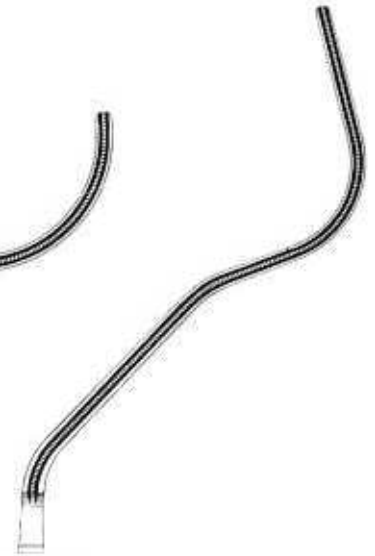

**Z-20-071-180**  
18 cm, 7"

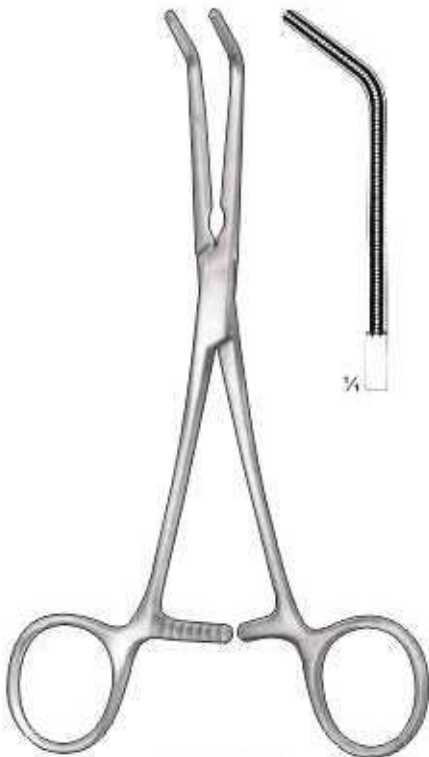

**HUSFELDT**  
**Z-20-072-175**  
17.5 cm, 7"

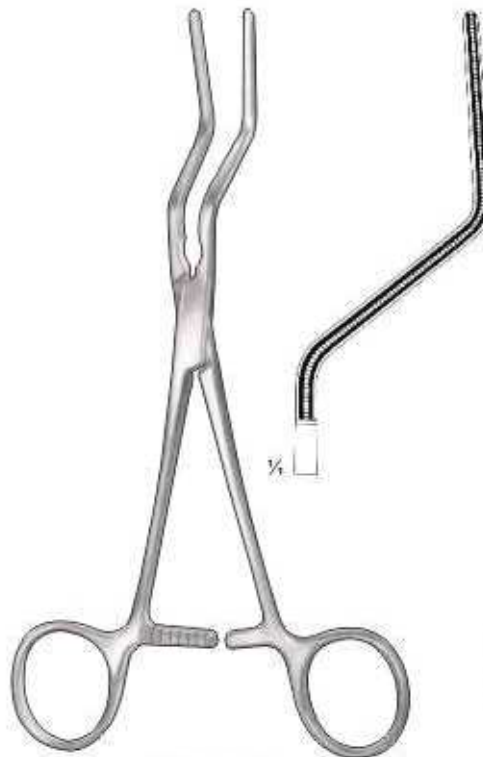

**HUSFELDT**  
**Z-20-073-175**  
17.5 cm, 7"

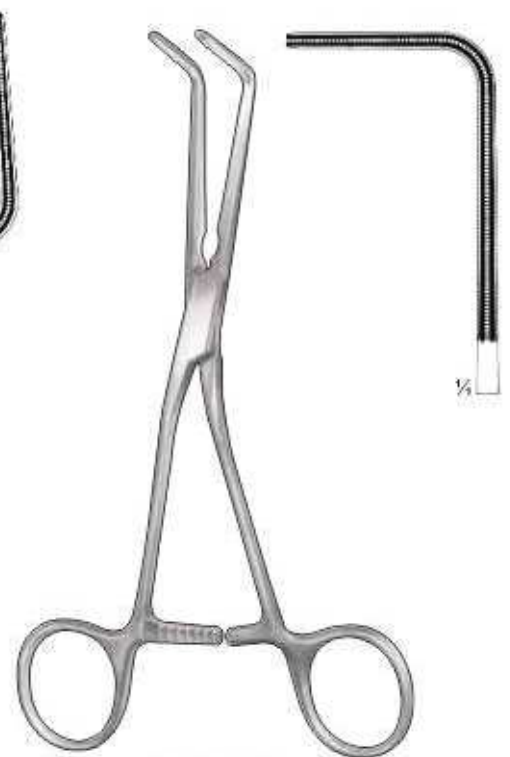

**HUSFELDT**  
**Z-20-074-170**  
17 cm, 6 3/4"

Thorax-cardiovasculaire  
Thorax-cardiovasculair

Torace-cardiovascolare  
Torax-cardiovascular

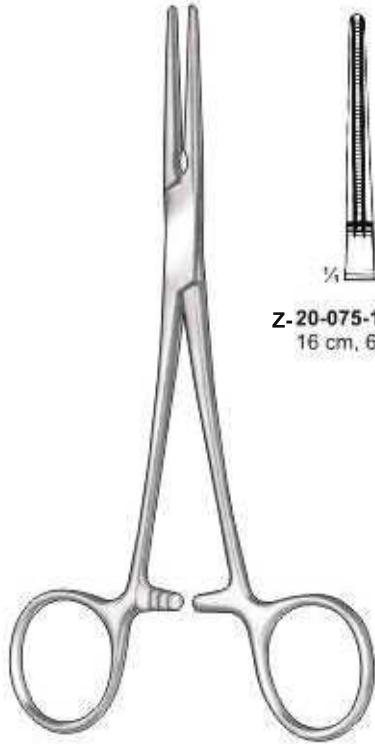

Z-20-075-160  
16 cm, 6 1/4"

DE BAKEY - RANKIN



Z-20-076-160  
16 cm, 6 1/4"



Z-20-077-150  
15 cm, 6"

DE BAKEY - MOSQUITO



Z-20-078-150  
15 cm, 6"



Z-20-079-210 Z-20-080-220  
21 cm, 8 1/4" 22 cm, 8 3/4"

POTTS



POTTS  
Z-20-081-220  
22 cm, 8 3/4"

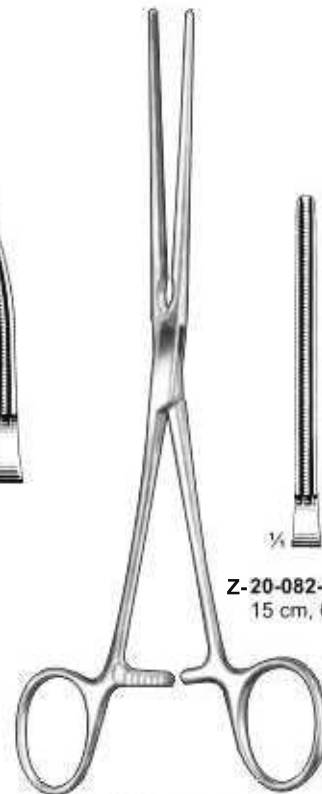

Z-20-082-150 Z-20-083-180  
15 cm, 6" 18 cm, 7"

BAINBRIDGE

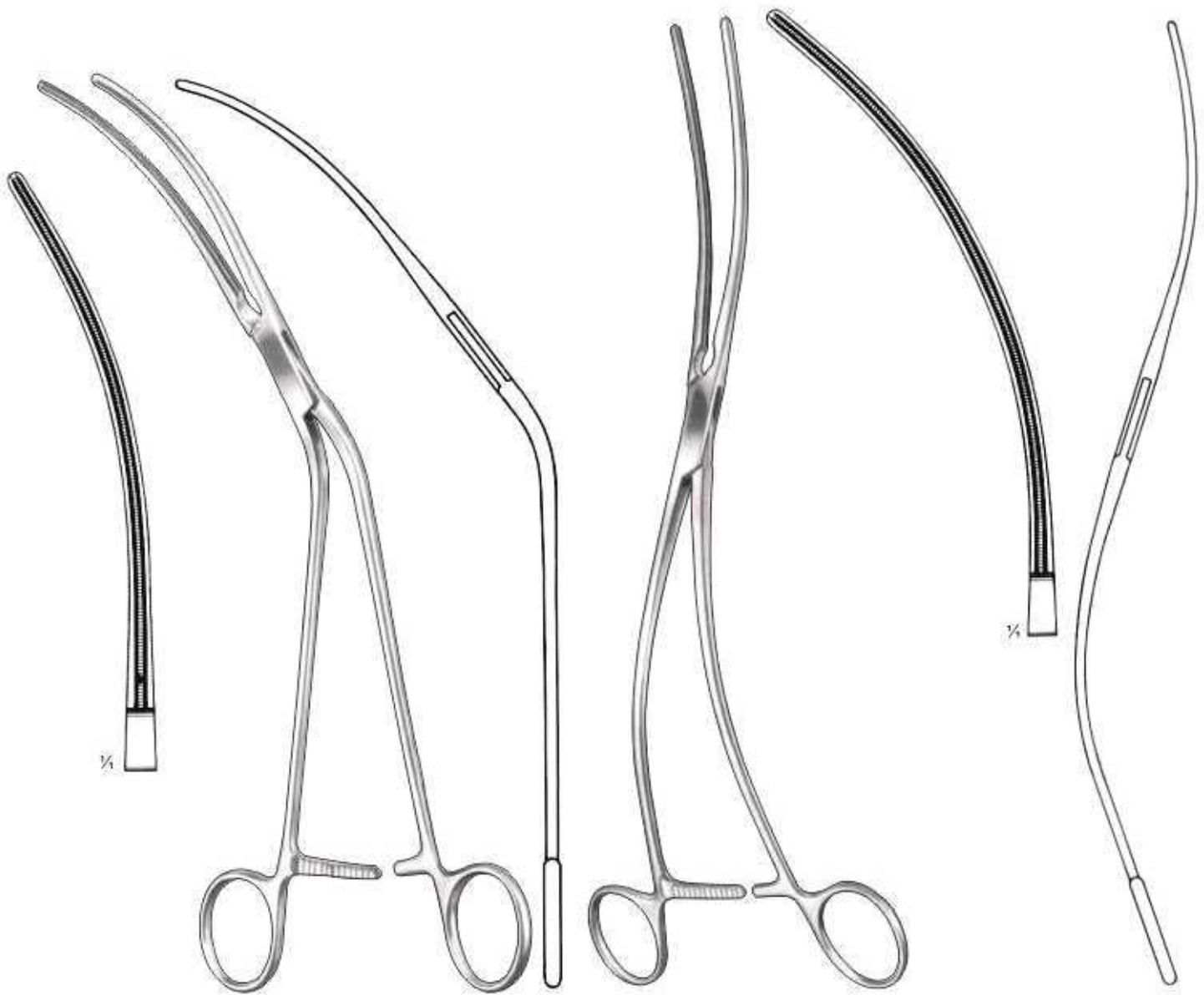

**DE BAKEY**  
Z-20-084-280  
28 cm, 11"

**DE BAKEY**  
Z-20-085-300  
30 cm, 11 3/4"

Thorax-cardiovasculaire  
Thorax-cardiovasculair

Torace-cardiovascolare  
Torax-cardiovascular



**WEBER**  
Z-20-086-260  
26 cm, 10 1/4"  
left

**WEBER**  
Z-20-087-260  
26 cm, 10 1/4"  
right

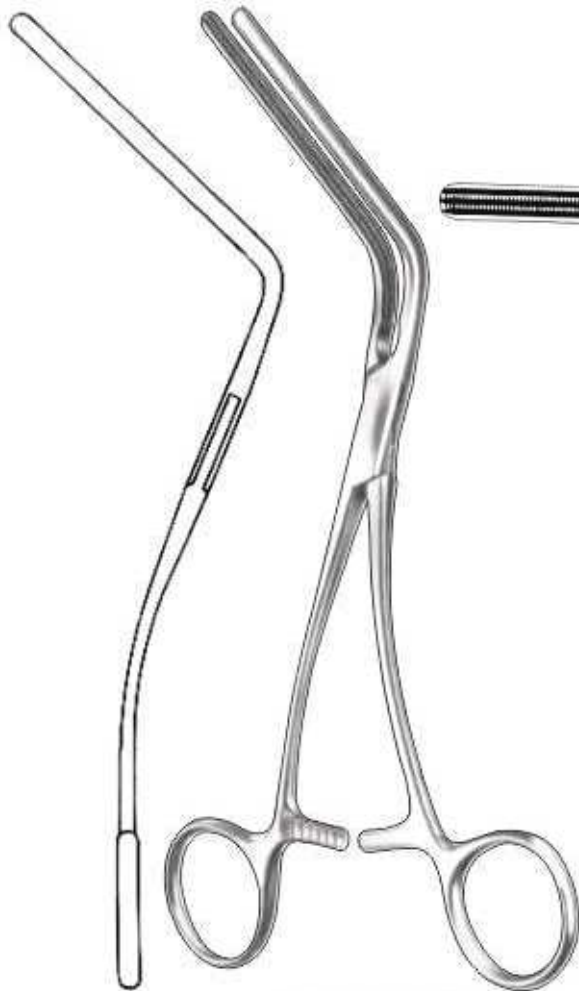

**MORRIS-DE BAKEY**



**Z-20-088-180**  
18 cm, 7"

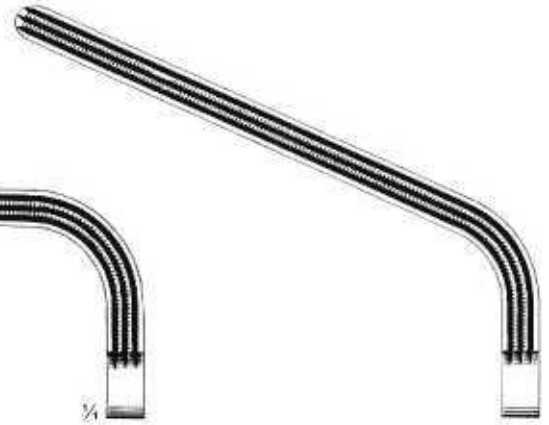

**Z-20-089-200**  
20 cm, 8"



**Z-20-090-230**  
23 cm, 9"



**Z-20-091-250**  
25 cm, 10"

Thorax-cardiovasculaire  
Thorax-cardiovasculair

Torace-cardiovascolare  
Torax-cardiovascular



DE BAKY - BAHNSON



$\frac{1}{4}$   
Z-20-092-230  
23 cm, 9"

Z-20-093-240  
24 cm, 9 1/2"

Z-20-094-250  
25 cm, 10"





**DE BAKEY**  
Z-20-095-100  
10 cm, 4"



**DE BAKEY**  
Z-20-096-110  
11 cm, 4 1/4"

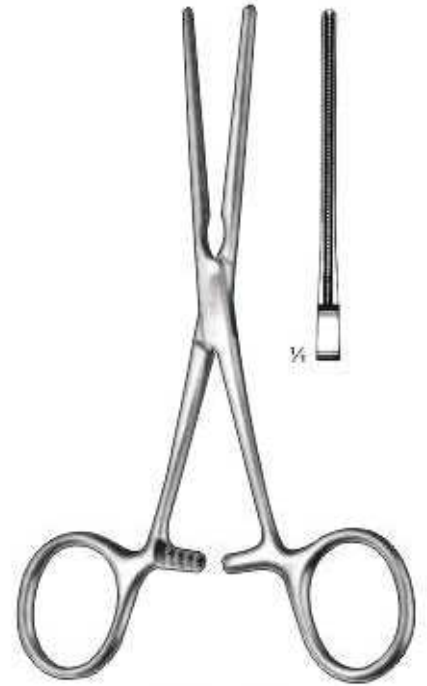

**DE BAKEY**  
Z-20-097-120  
12 cm, 4 3/4"

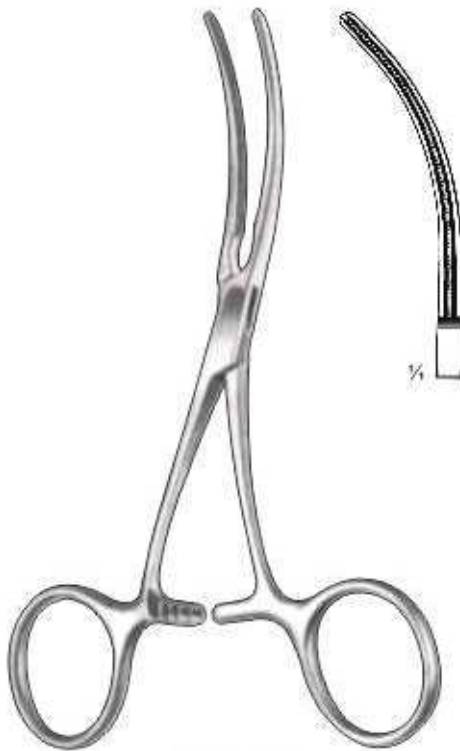

**DE BAKEY**  
Z-20-098-120  
12 cm, 4 3/4"



**DE BAKEY**  
Z-20-099-130  
13 cm, 5 1/4"





20-100-140 Z-20-101-140  
 14 cm, 5 1/2" 14 cm, 5 1/2"

COOLEY

COOLEY  
 Z-20-102-140  
 14 cm, 5 1/2"

COOLEY  
 Z-20-103-140  
 14 cm, 5 1/2"

COOLEY  
 Z-20-104-140  
 14 cm, 5 1/2"

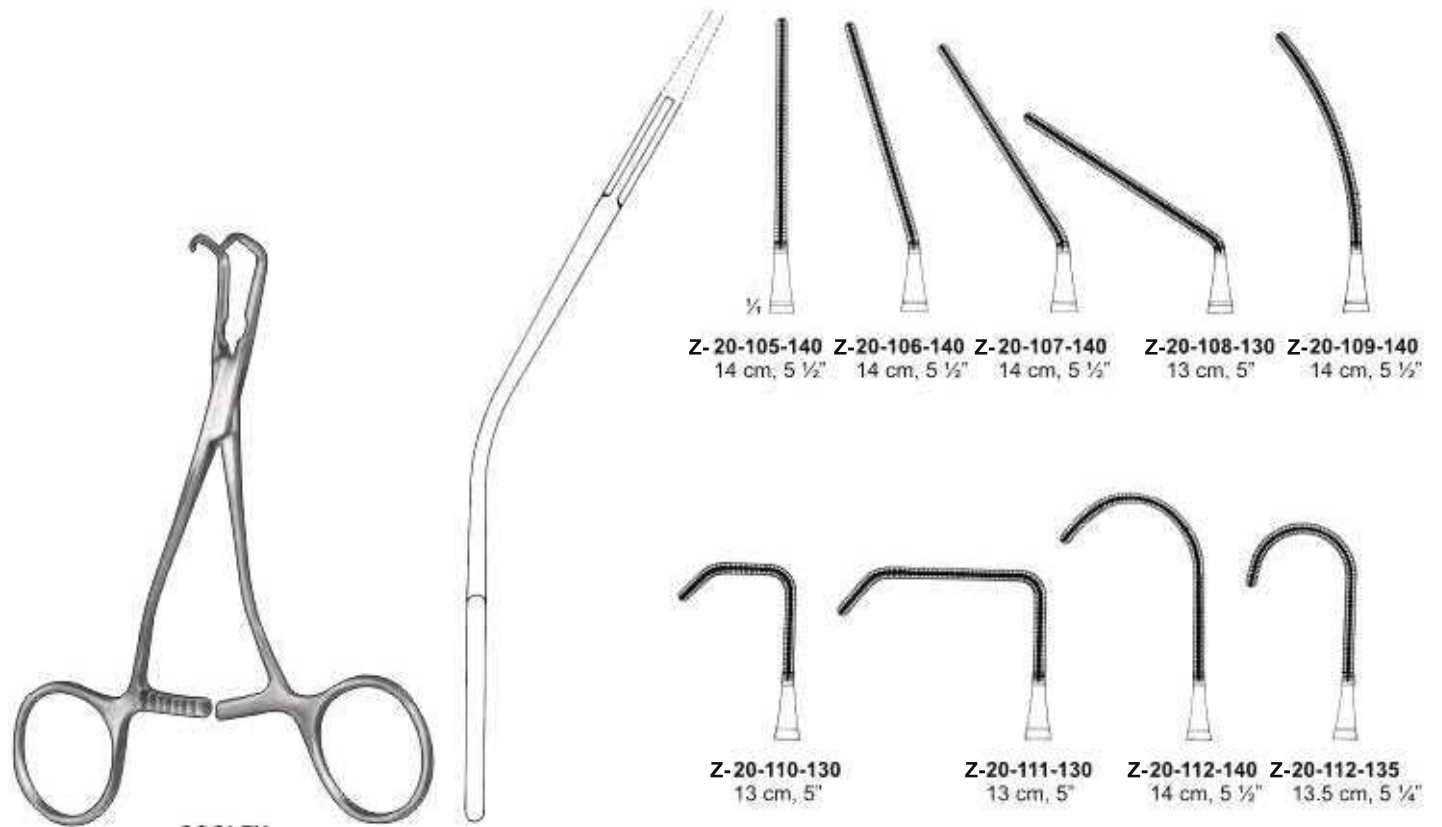

COOLEY

Z-20-105-140 Z-20-106-140 Z-20-107-140 Z-20-108-130 Z-20-109-140  
 14 cm, 5 1/2" 14 cm, 5 1/2" 14 cm, 5 1/2" 13 cm, 5" 14 cm, 5 1/2"

Z-20-110-130 Z-20-111-130 Z-20-112-140 Z-20-112-135  
 13 cm, 5" 13 cm, 5" 14 cm, 5 1/2" 13.5 cm, 5 1/4"

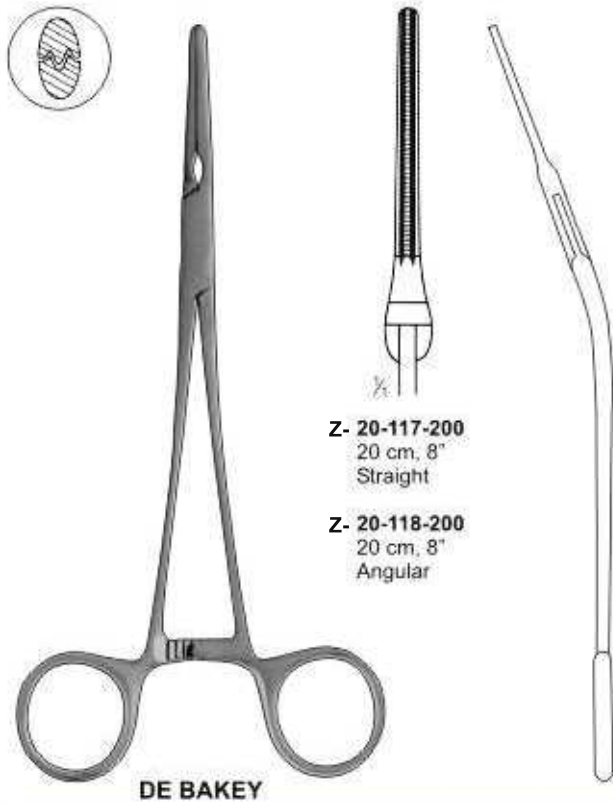
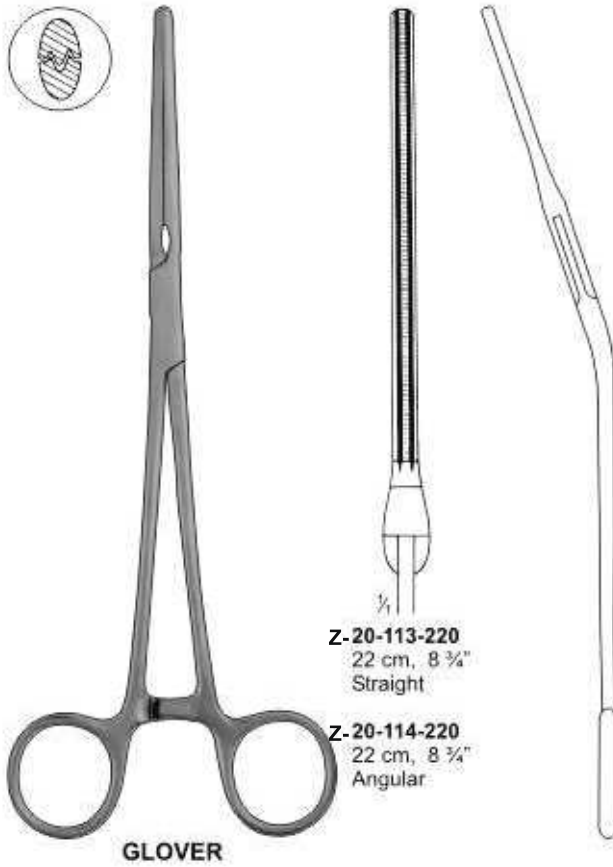

Thorax-cardiovasculaire  
Thorax-cardiovasculair

Torace-cardiovascolare  
Torax-cardiovascular

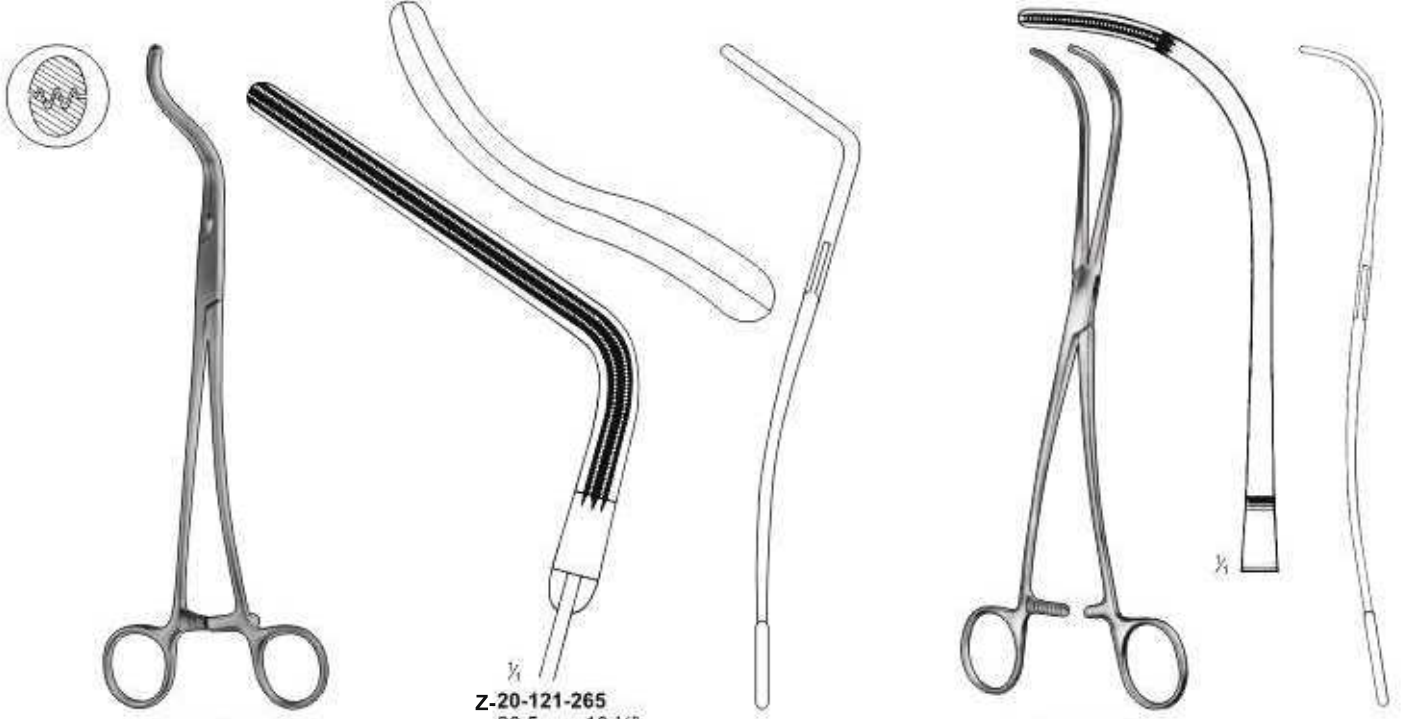

DE BAKEY

Z-20-121-265  
26.5 cm, 10 1/2"

DE BAKEY  
Z-20-122-240  
24 cm, 9 1/2"

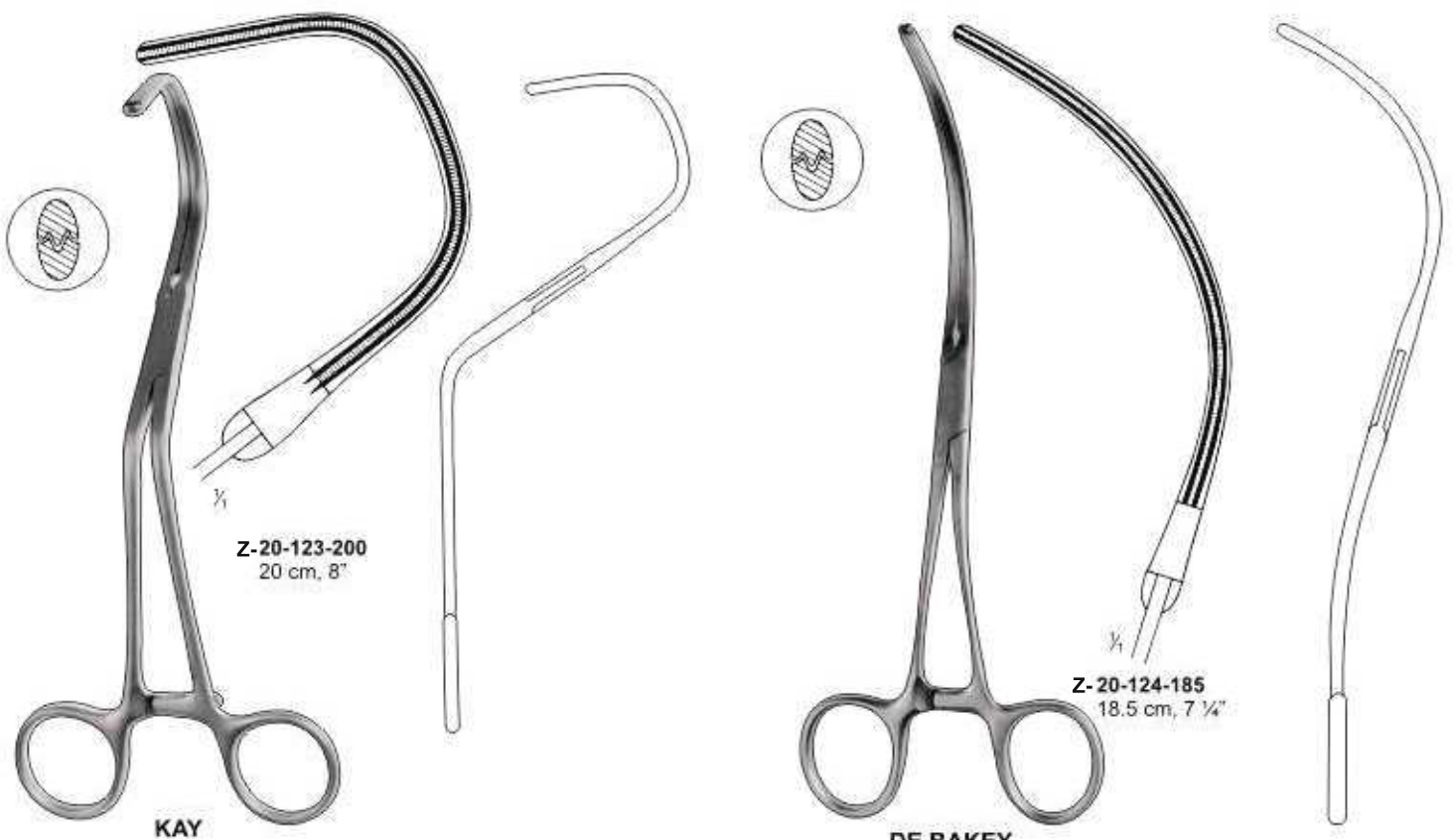

KAY

Z-20-123-200  
20 cm, 8"

DE BAKEY

Z-20-124-185  
18.5 cm, 7 1/4"

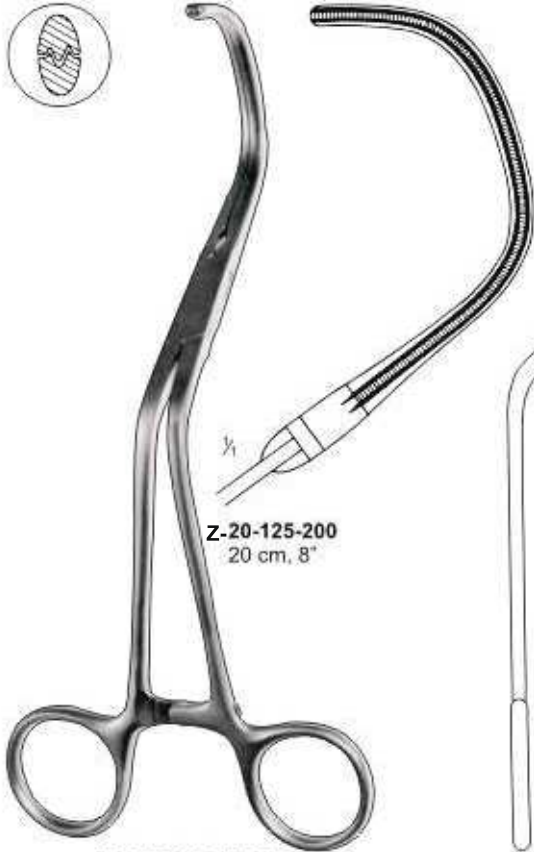

Z-20-125-200  
20 cm, 8"

**LAMBERT-KAY**



Z-20-126-250  
25 cm, 10"

**LEES**  
Double Bent



Z-20-127-280 28 cm, 11"    Z-20-128-300 30 cm, 12"    Z-20-129-320 32 cm, 12 1/2"    Z-20-130-340 34 cm, 13 1/2"

**DE BAKEY**

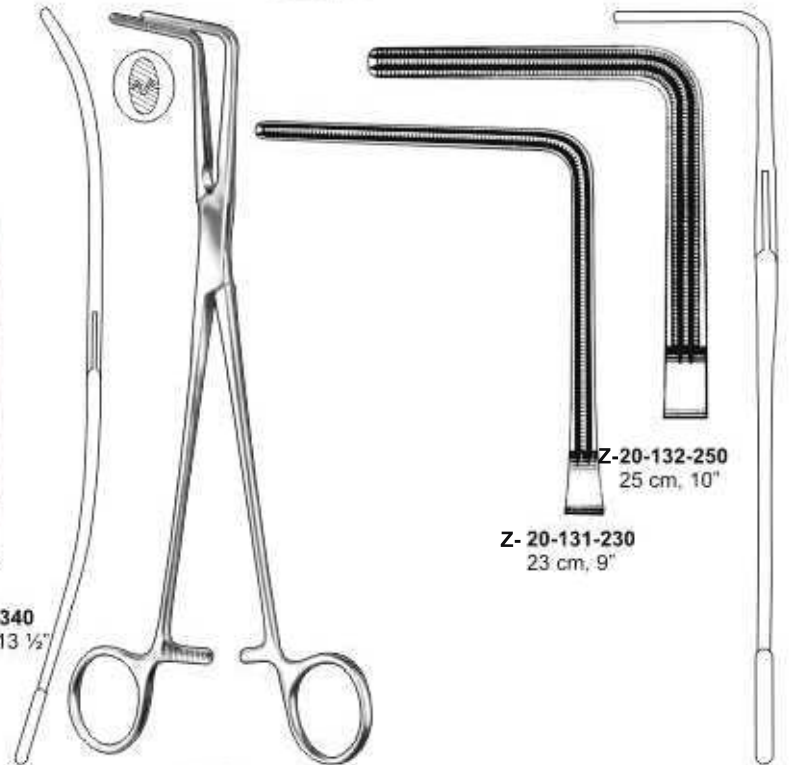

Z-20-132-250  
25 cm, 10"

Z-20-131-230  
23 cm, 9"

**LEES**  
Right Angled Jaws

Thorax-cardiovasculaire  
Thorax-cardiovasculair

Torace-cardiovascolare  
Torax-cardiovascular

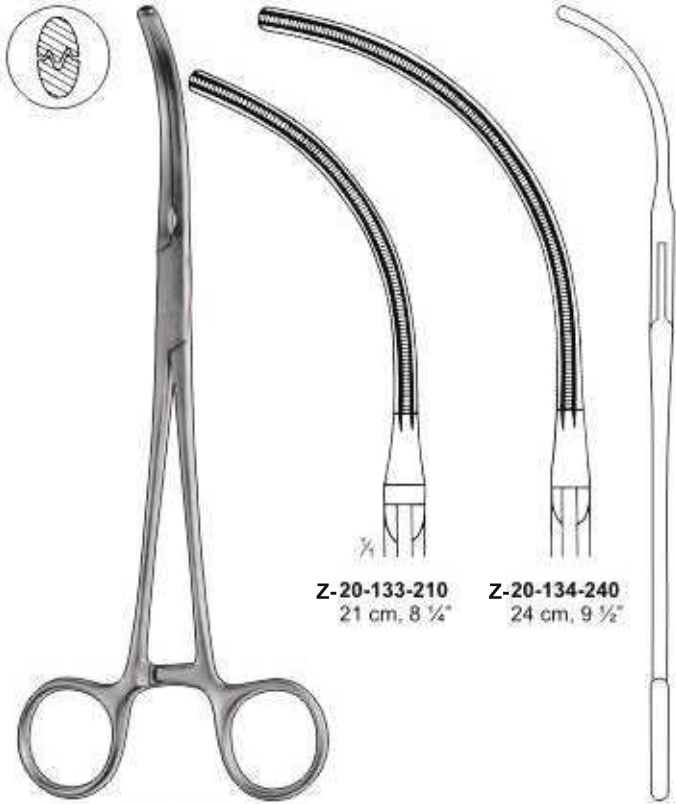

Z-20-133-210  
21 cm, 8 1/4"

Z-20-134-240  
24 cm, 9 1/2"

GLOVER



Z-20-135-190  
19 cm, 7 1/4"  
Full Curved

GLOVER



Z-20-136-215  
21.5 cm, 8 1/4"

Z-20-137-260  
26 cm, 10 1/4"

GLOVER  
spoon-shaped



Z-20-138-260  
26 cm, 10 1/4"

DE BAKY

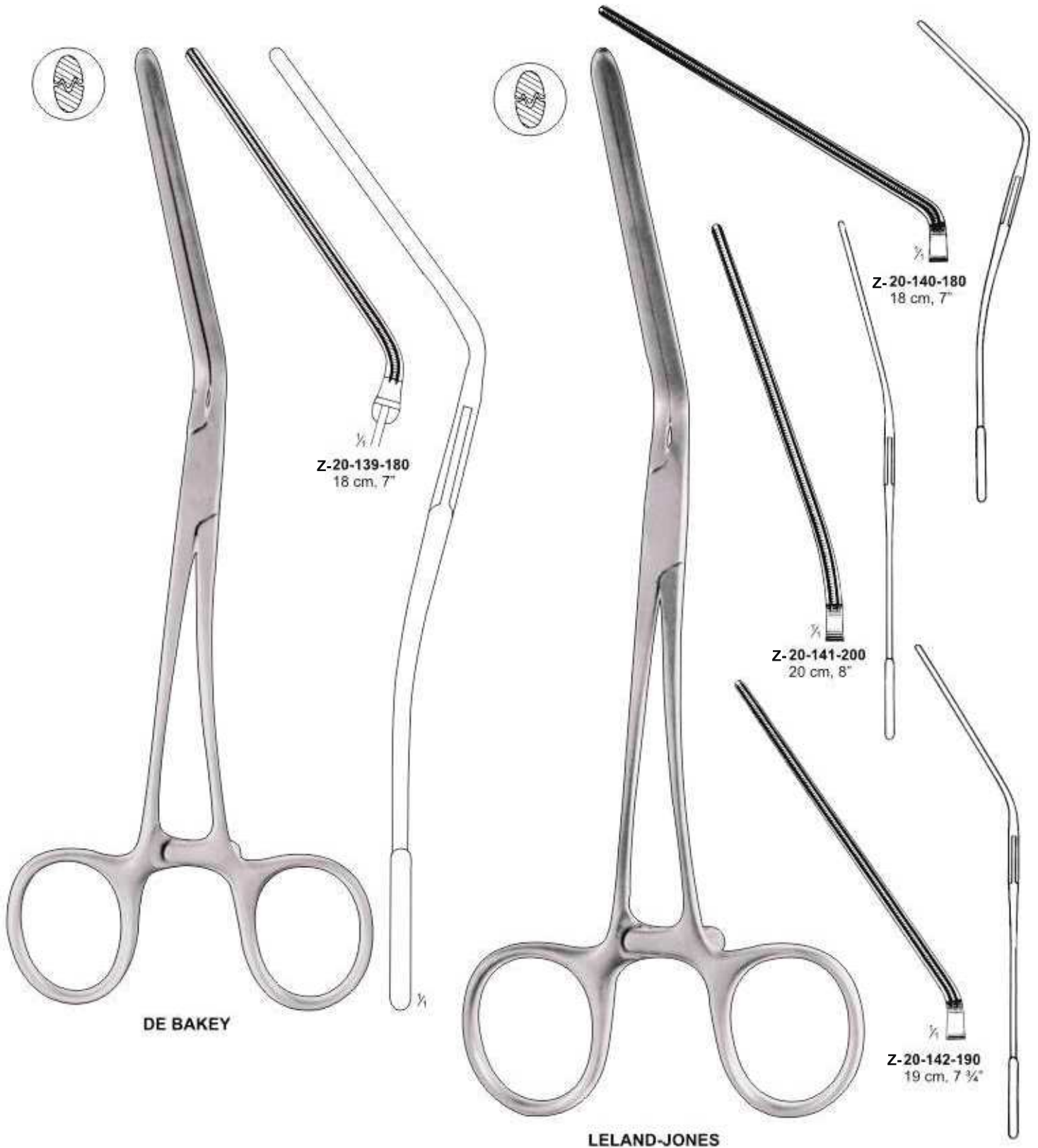

Thorax-cardiovasculaire  
Thorax-cardiovasculair

Torace-cardiovascolare  
Torax-cardiovascular

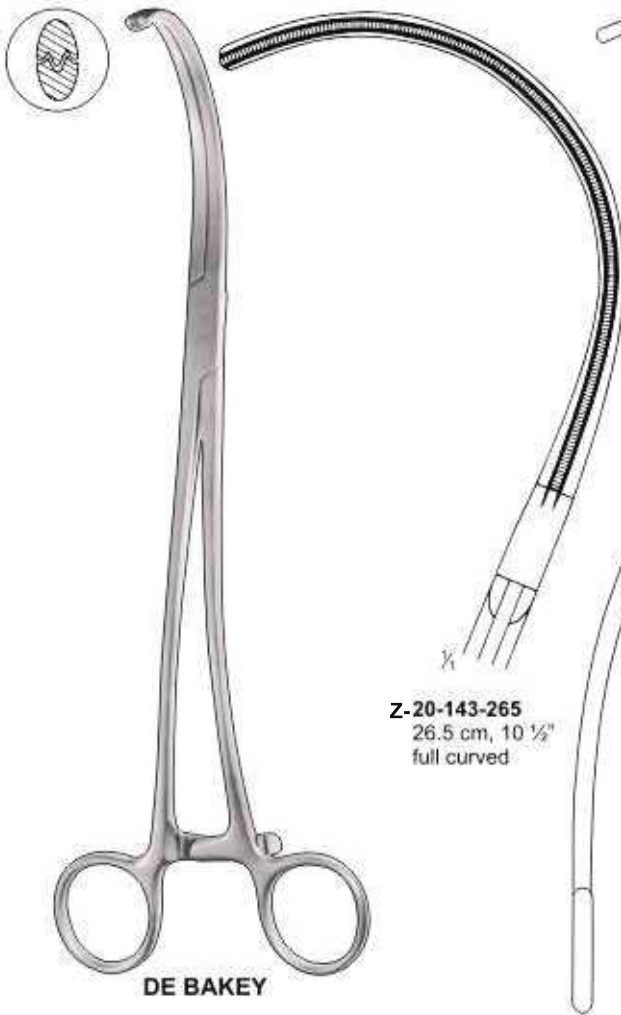

DE BAKEY

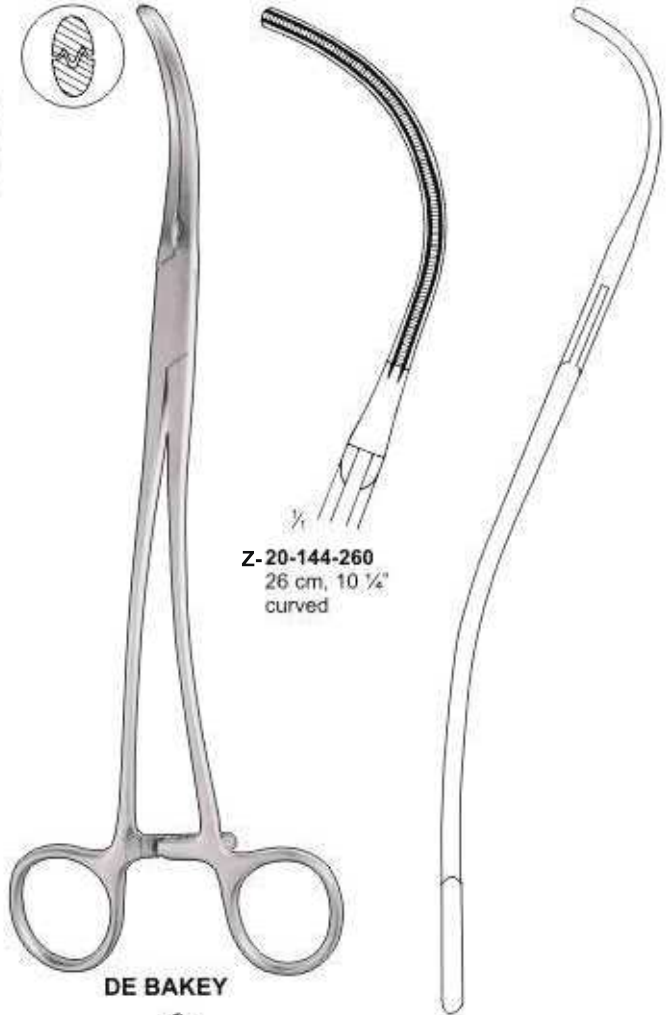

DE BAKEY



DE BAKEY

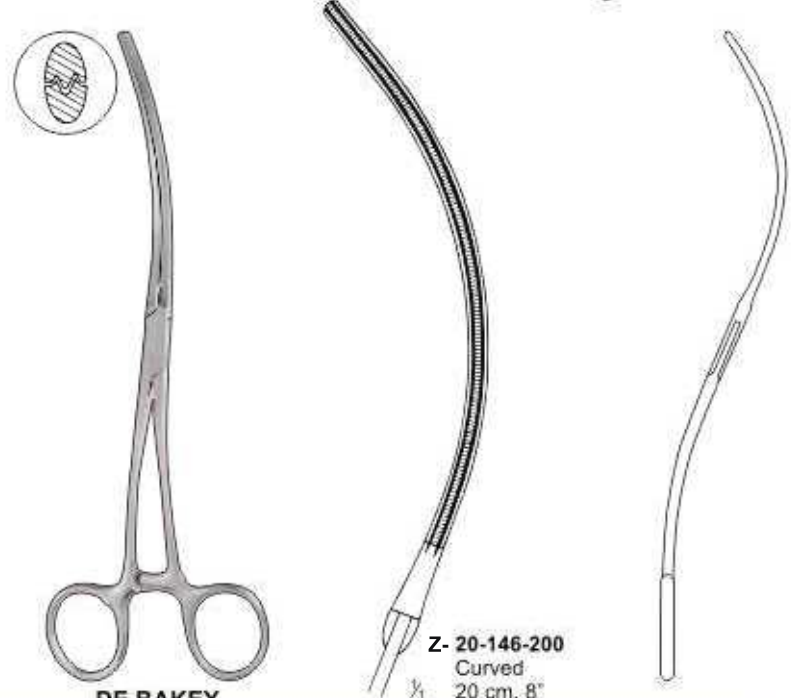

DE BAKEY



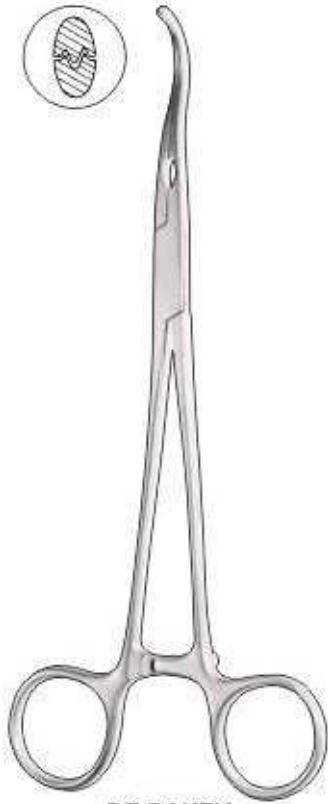

**DE BAKEY**  
Ligature Carrier



**Z-20-147-210**  
21 cm, 8 1/4"



**Z-20-148-240**  
24 cm, 9 1/2"



**DE BAKEY**  
Right Angled Jaws

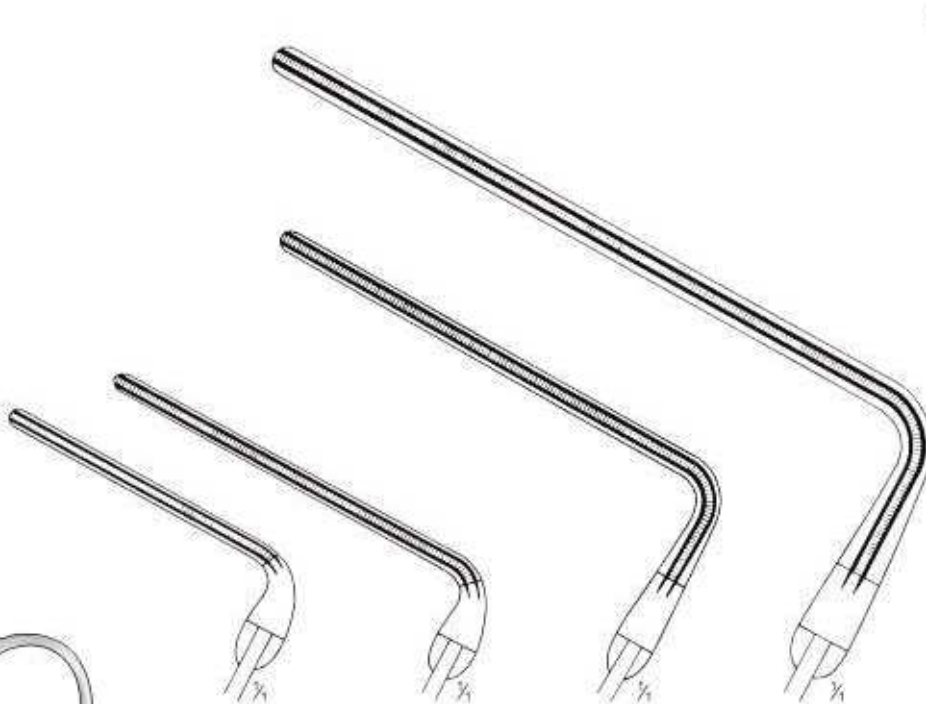

**Z-20-149-200**  
20 cm, 8"

**Z-20-150-190**  
19 cm, 7 1/2"

**Z-20-151-220**  
22 cm, 8 3/4"

**Z-20-152-270**  
27 cm, 10 3/4"





60° angled jaws



**DE BAKHEY**

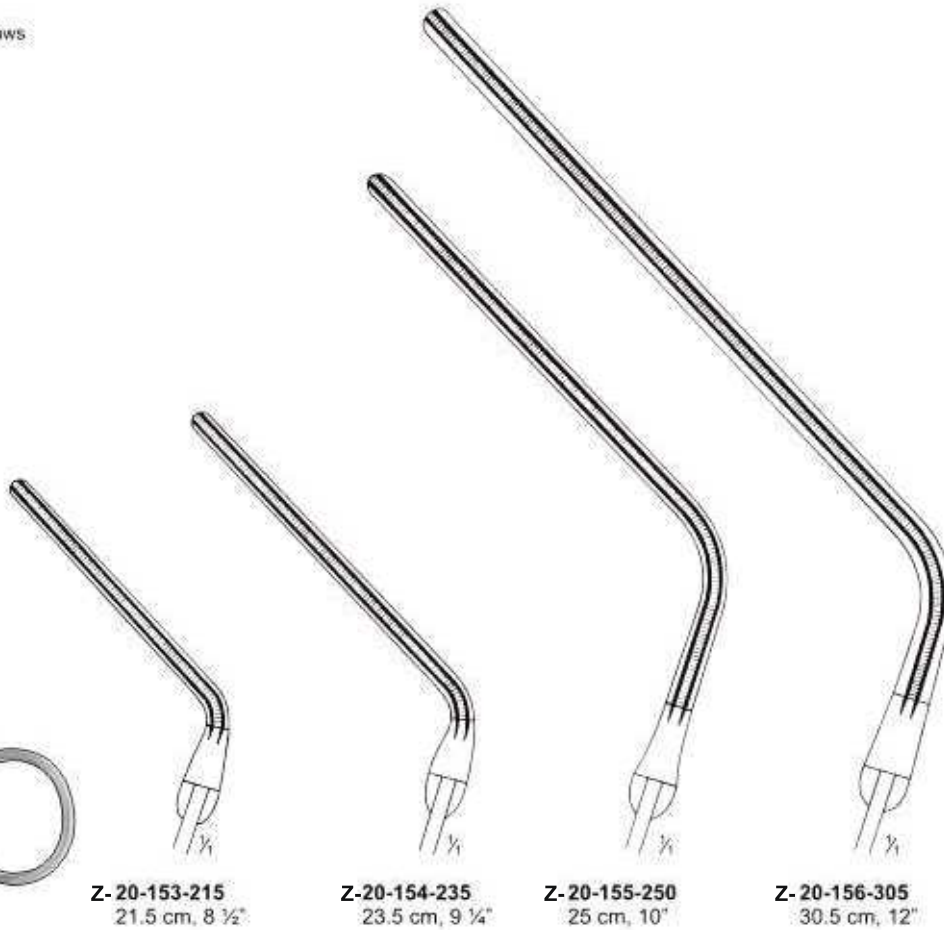

**Z-20-153-215**  
21.5 cm, 8 1/2"

**Z-20-154-235**  
23.5 cm, 9 1/4"

**Z-20-155-250**  
25 cm, 10"

**Z-20-156-305**  
30.5 cm, 12"



**DE BAKHEY**

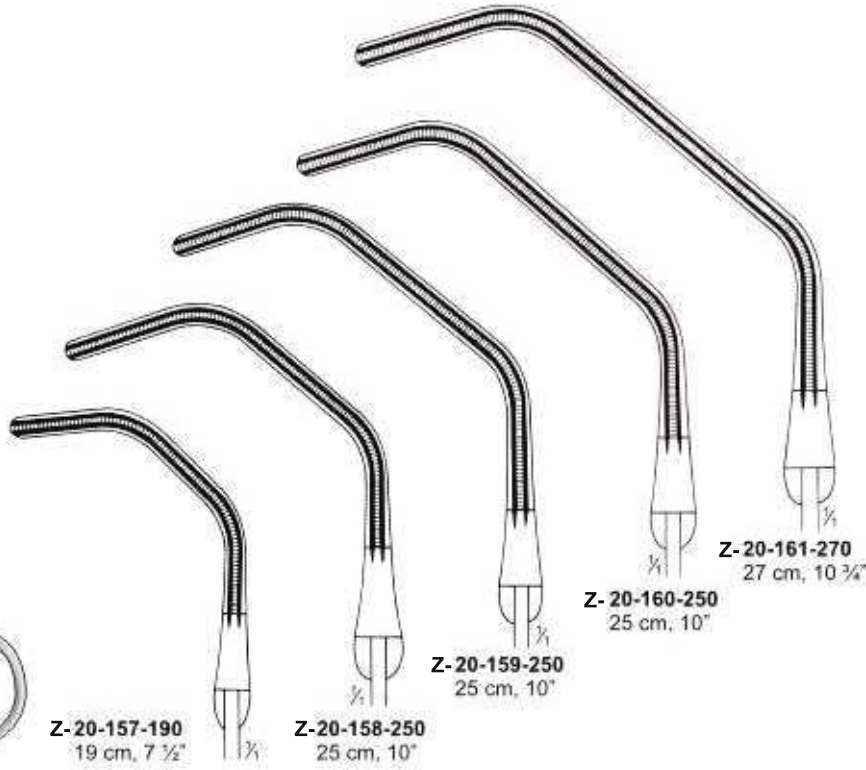

**Z-20-157-190**  
19 cm, 7 1/2"

**Z-20-158-250**  
25 cm, 10"

**Z-20-159-250**  
25 cm, 10"

**Z-20-160-250**  
25 cm, 10"

**Z-20-161-270**  
27 cm, 10 3/4"



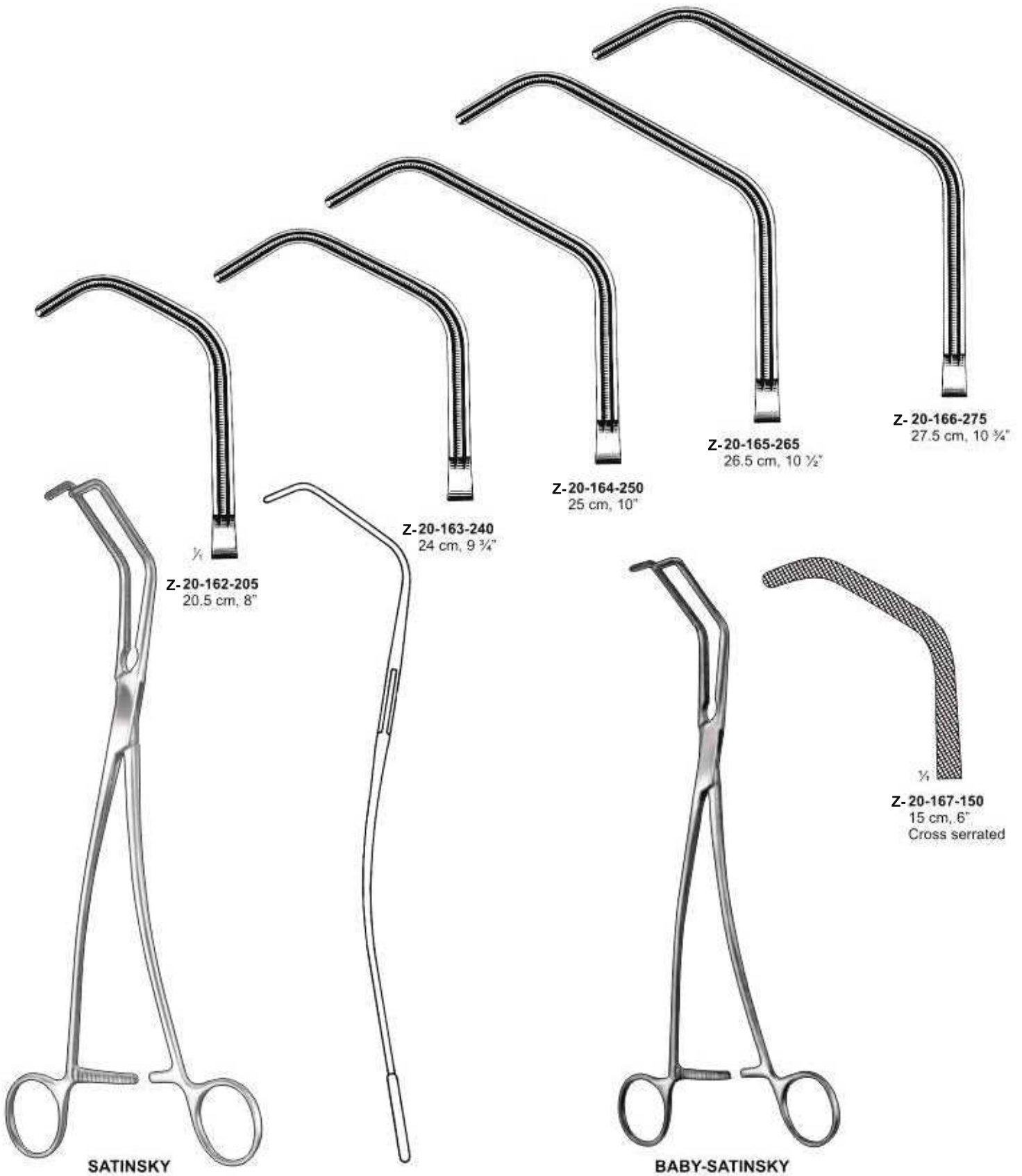

Thorax-cardiovasculaire  
Thorax-cardiovasculair

Torace-cardiovascolare  
Torax-cardiovascular



Z-20-168-250  
25 cm, 10"

GLOVER



Z-20-169-215 Z-20-170-260  
21.5 cm, 8 1/2" 26 cm, 10 1/4"

COOLEY

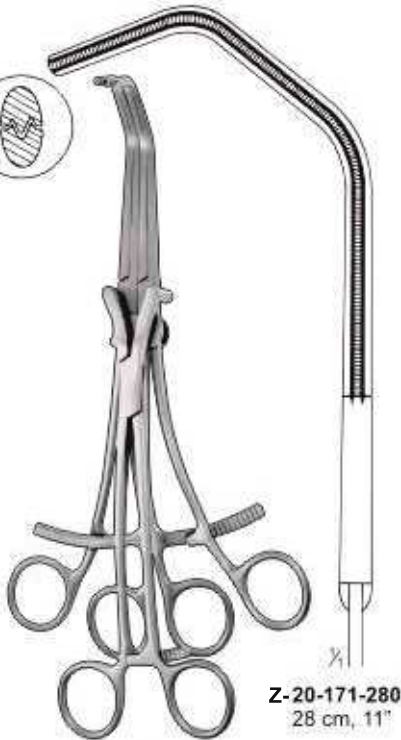

Z-20-171-280  
28 cm, 11"

PENZSUOLI



CASTANEDA



Z-20-172-130 Z-20-173-130  
13 cm, 5" 13 cm, 5"

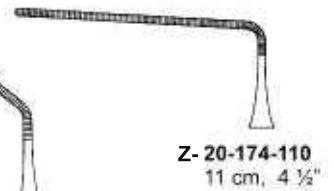

Z-20-174-110  
11 cm, 4 1/2"



Z-20-175-120 Z-20-176-120 Z-20-177-120 Z-20-178-120  
12 cm, 4 3/4" 12 cm, 4 3/4" 12 cm, 4 3/4" 12 cm, 4 3/4"

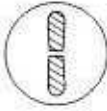

Straight



**Z-20-179-130**  
13 cm, 5"

30° angle



**Z-20-180-130**  
13 cm, 5"

50° angle



**Z-20-181-130**  
13 cm, 5"

90° angle



**Z-20-182-110**  
11 cm, 4 1/4"

70° angle



**Z-20-183-120**  
12 cm, 5"



**Z-20-184-120**  
12 cm, 5"

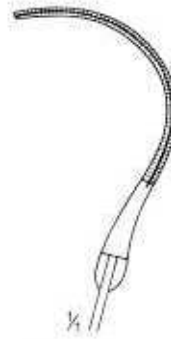

**Z-20-185-130**  
13 cm, 5"





**CASTANEDA**



**Z-20-186-150**  
15 cm, 6"



**Z-20-187-150**  
15 cm, 6"



**Z-20-188-150**  
15 cm, 6"



**CASTANEDA**



**Z-20-189-160**  
16 cm, 6 1/4"



**Z-20-190-160**  
16 cm, 6 1/4"

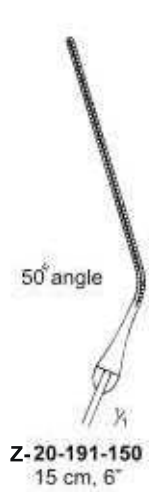

**Z-20-191-150**  
15 cm, 6"

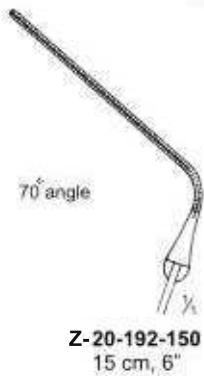

**Z-20-192-150**  
15 cm, 6"

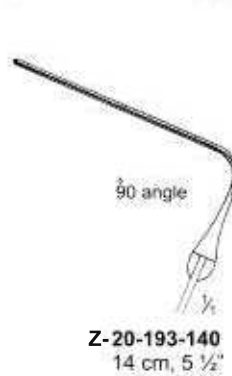

**Z-20-193-140**  
14 cm, 5 1/2"



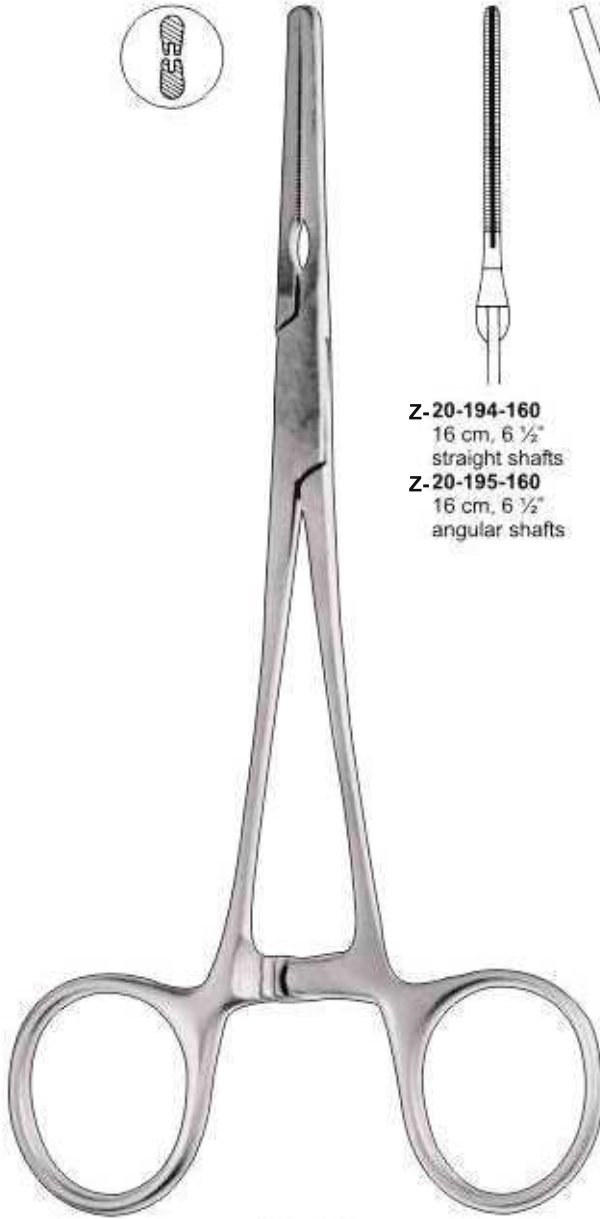

**COOLEY**  
straight jaws  
angled shanks

**Z-20-194-160**  
16 cm, 6 1/2"  
straight shafts  
**Z-20-195-160**  
16 cm, 6 1/2"  
angular shafts

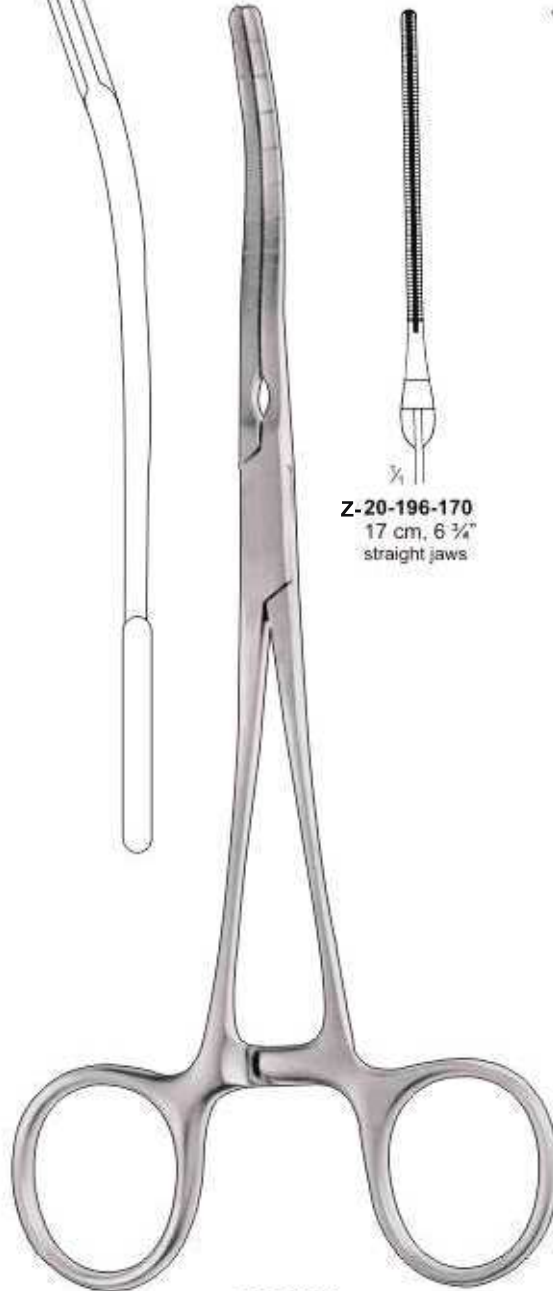
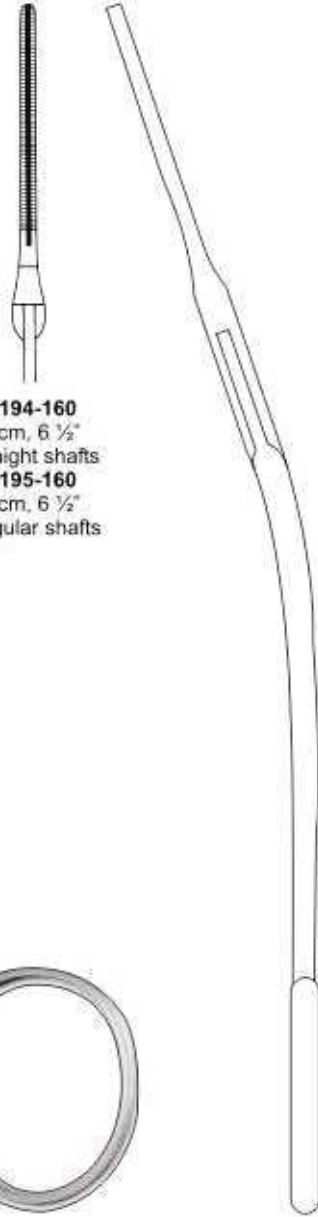

**COOLEY**

**Z-20-196-170**  
17 cm, 6 3/4"  
straight jaws

**Z-20-197-170**  
17 cm, 6 3/4"  
curved jaws

**Z-20-198-170**  
17 cm, 6 3/4"  
spoon-shaped  
jaws

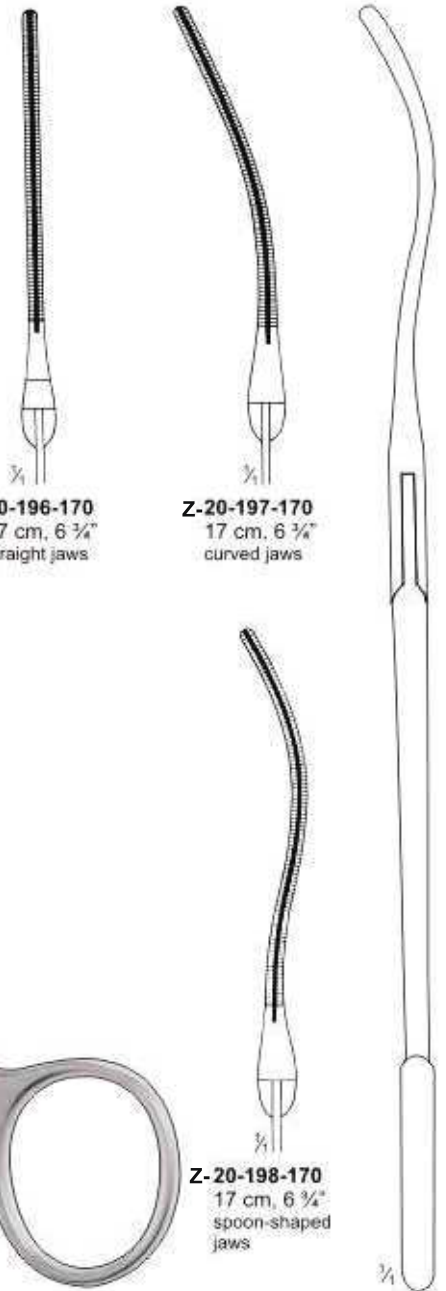

Thorax-cardiovasculaire  
Thorax-cardiovasculaire

Torace-cardiovascolare  
Torax-cardiovascular





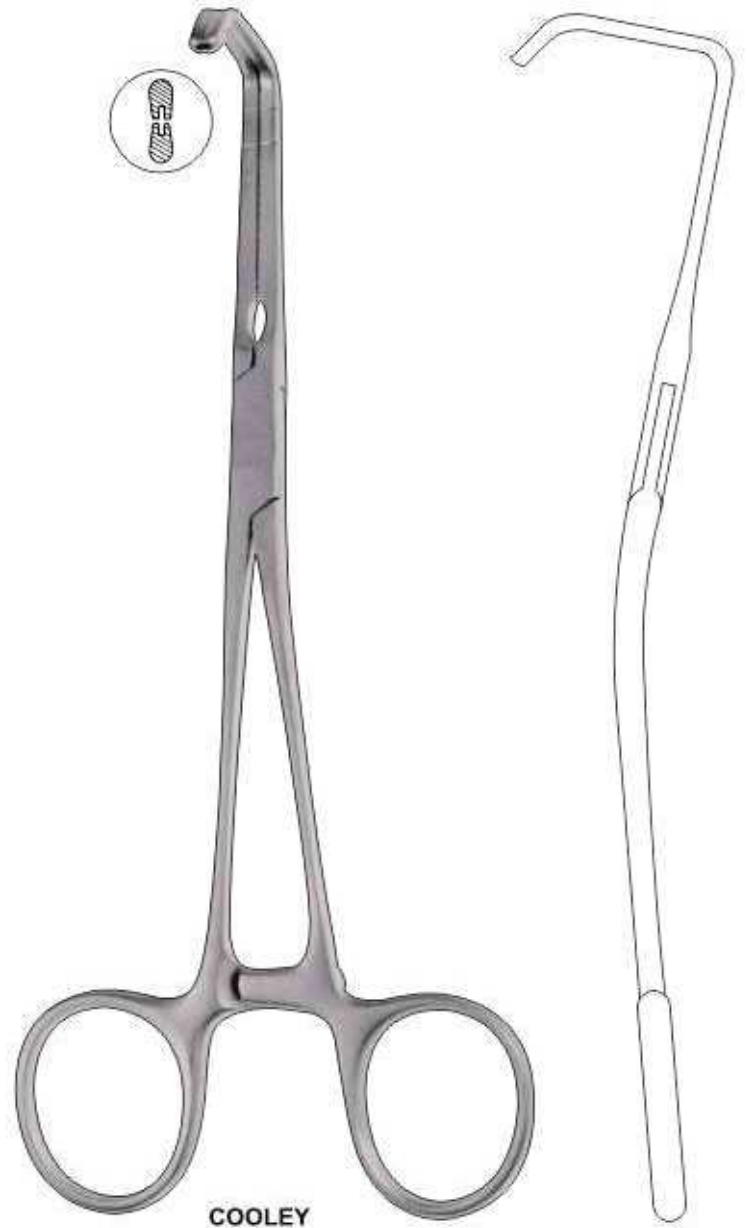
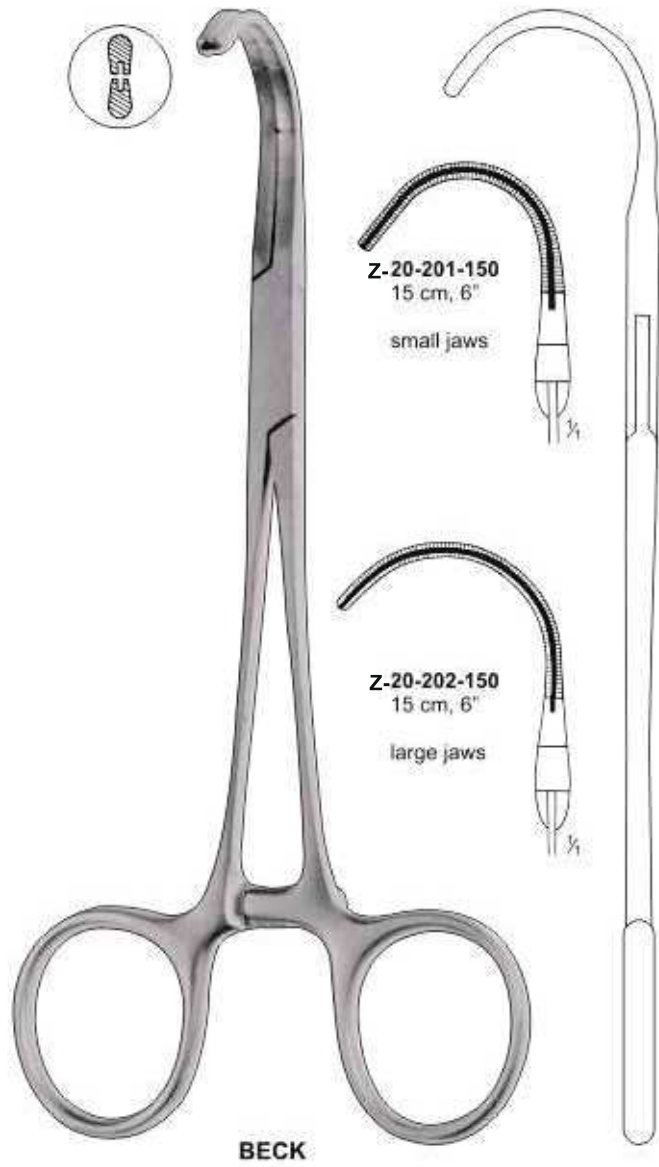

Thorax-cardiovasculaire  
Thorax-cardiovasculair

Torace-cardiovascolare  
Torax-cardiovascular



COOELY



Z-20-207-165  
16.5 cm, 6 1/2"  
medium jaws

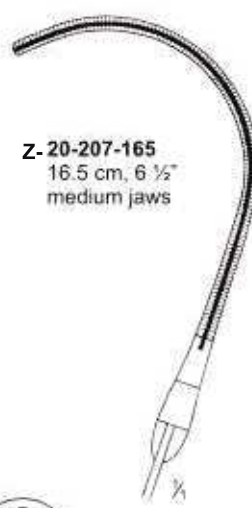

Z-20-208-170  
17 cm, 6 3/4"  
large jaws

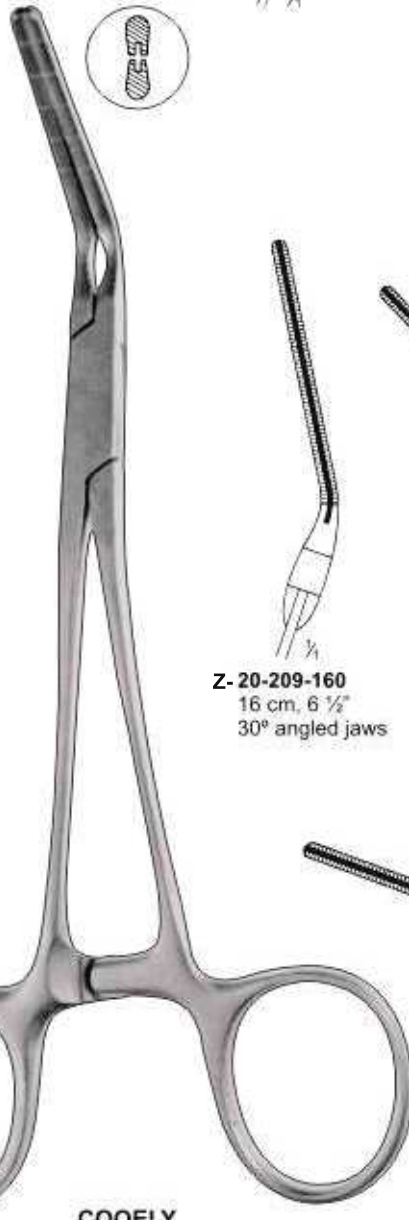
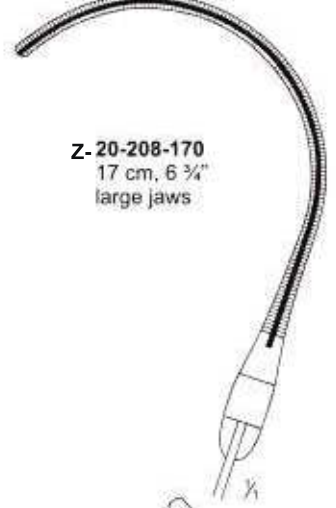

COOELY

Z-20-209-160  
16 cm, 6 1/2"  
30° angled jaws



Z-20-210-160  
16 cm, 6 1/2"  
60° angled jaws



Z-20-211-160  
16 cm, 6 1/2"  
90° angled jaws

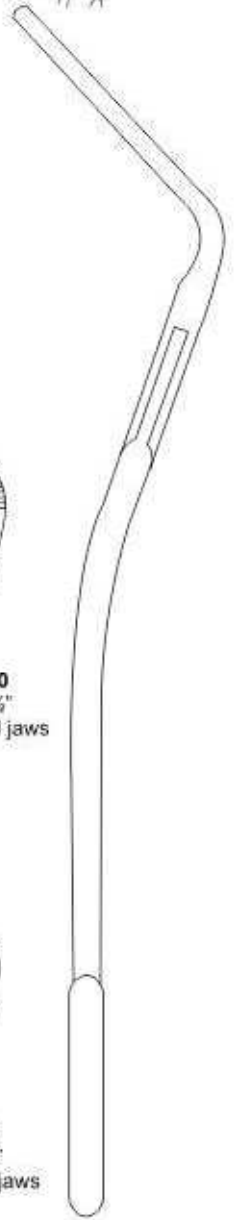



**Z-20-212-165**  
16.5 cm, 6 1/2"



**Z-20-213-170**  
17 cm, 6 3/4"



**Z-20-214-180**  
18 cm, 7"

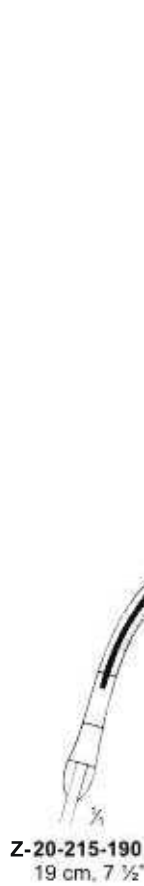

**BRONCHUS CLAMPS, CAROTIS-SHUNT CLAMPS**

Bronchusklemmen, Carotis-Shuntklemmen  
Pinzas bronquiales, Pinzas para shunt carotido

Pince-clamps à bronches, Pincés pour carotide  
Pinze per bronchi, Pinze carotis



**Z-20-218-220**  
jaw with ns

**Z-20-219-220**  
jaw with ns

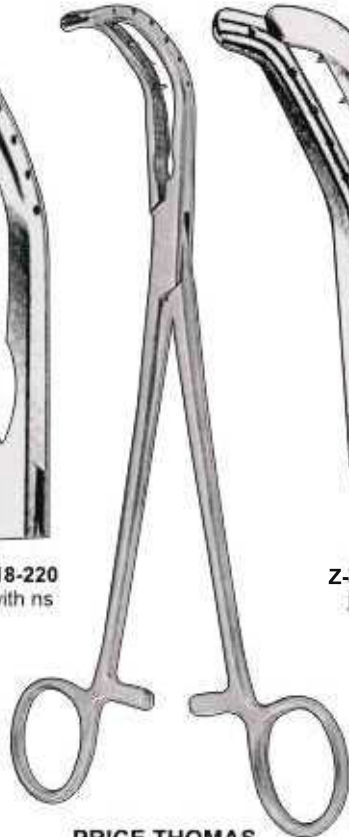

**PRICE THOMAS**  
Bronchus Clamp  
22 cm, 8 3/4"



**PRICE-THOMAS**  
22 cm, 8 3/4"



**Z-20-220-220**  
22 cm, 8 3/4"



**JAVID**



**Z-20-221-180**  
18 cm, 7"  
Small,  
4mm Ring



**DE BAKEY / PEDIATRIC**



**Z-20-222-120**  
12 cm, 5"  
Angled, 43mm tip



**BAILEY-GIBBON**  
Z-20-223-200  
20 cm, 8"  
For Adult



**Z-20-224-200**  
20 cm, 8"  
For children



**BAILEY-BABY**  
Z-20-225-150  
15 cm, 6"



**SELLORS RIB CONTRACTOR**  
Z-20-226-200  
20 cm, 8"



**BLALOCK**



**Z-20-227-150**  
15 cm, 6"

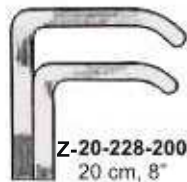

**Z-20-228-200**  
20 cm, 8"

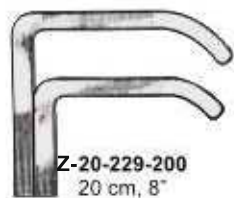

**Z-20-229-200**  
20 cm, 8"

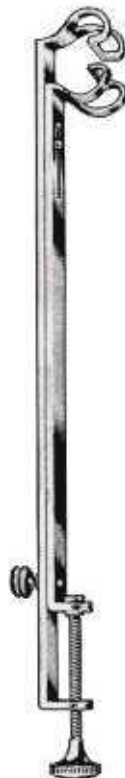

**JOHNS-HOPKINS  
(POTTS Modif.)**

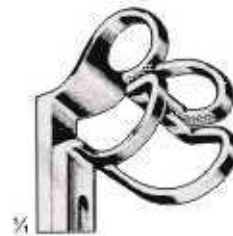

**Z-20-230-200**  
20 cm, 8"



**Z-20-231-200**  
20 cm, 8"



**Z-20-232-200**  
20 cm, 8"

# LUNG SPATULAS, AORTIC DILATORS

Lungenspatel, Aorta-Dilatatoren  
Espátulas pulmonares, Dilatadores aórticos

Spatules pulmonaires, Dilatateurs pour aorte  
Spatole per pulmone, Dilatatori per aorta



**ALLISON**  
Z-20-233-250  
25 cm, 10"

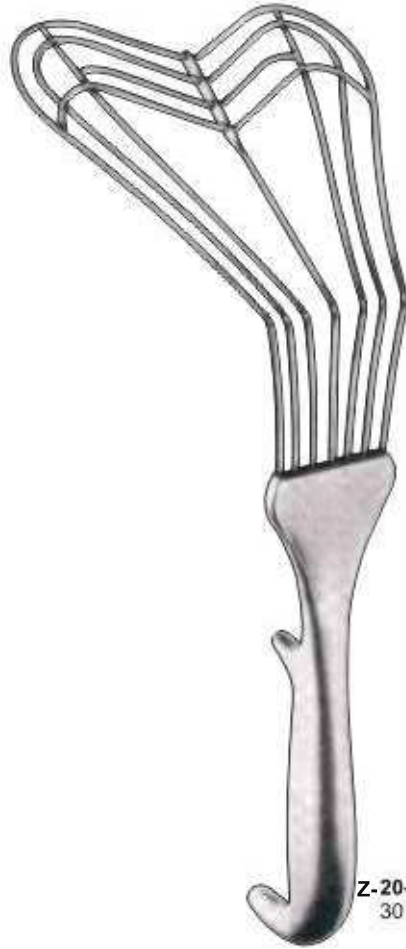

**Z-20-234-300**  
30 cm, 12"

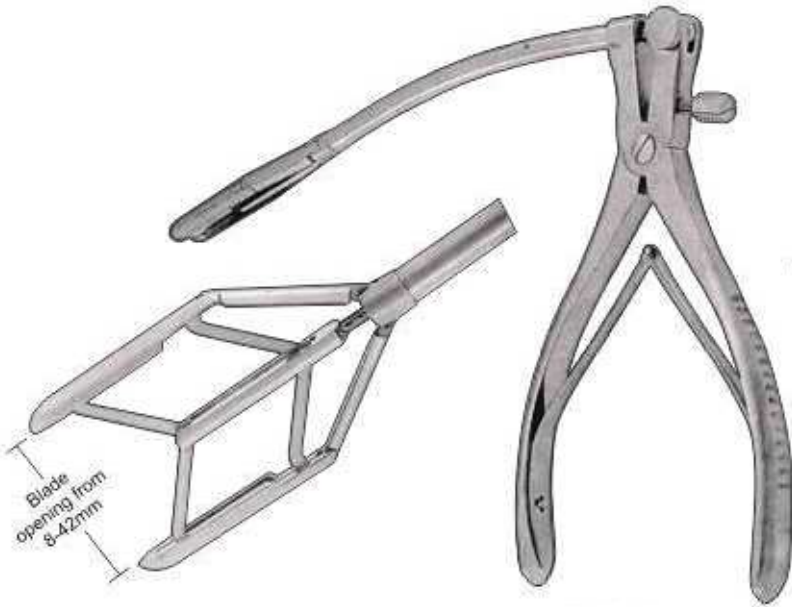

**TUBBS**  
Z-20-235-001  
Blade Opening  
From 8 To 42 mm

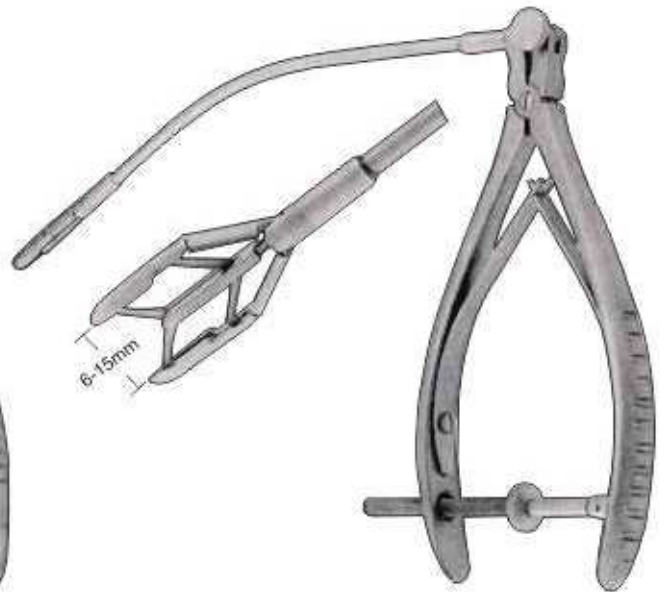

**COOLEY**  
Z-20-236-002  
Blade Opening  
From 8 To 15 mm



**COOLEY**  
**Z-20-237-001**  
latral blades 12 x 16 mm spreading 95 mm



**COOLEY**  
**Z-20-238-001** latral blades 15 x 30 mm, spreading 140 mm  
**Z-20-239-002** latral blades 21 x 44 mm, spreading 150 mm



**COOLEY**  
**Z-20-240-001**  
latral blades 35 x 50 mm, spreading 200 mm



**FINOCCHIETTO,**  
**Z-20-241-001**  
latral blades 15 x 15 mm, spreading 75 mm, infant  
latral blades 31 x 31 spreading 100 mm, baby - height  
latral blades 40 x 45 spreading 135 mm, baby - height  
latral blades 52 x 62 spreading 175 mm, baby - height  
latral blades 84 x 65 spreading 175 mm, baby - height



**HAIGHT RIB RETRACTOR**  
Z-20-242-001  
lateral blades 30 x 30 mm, spreading 120 mm

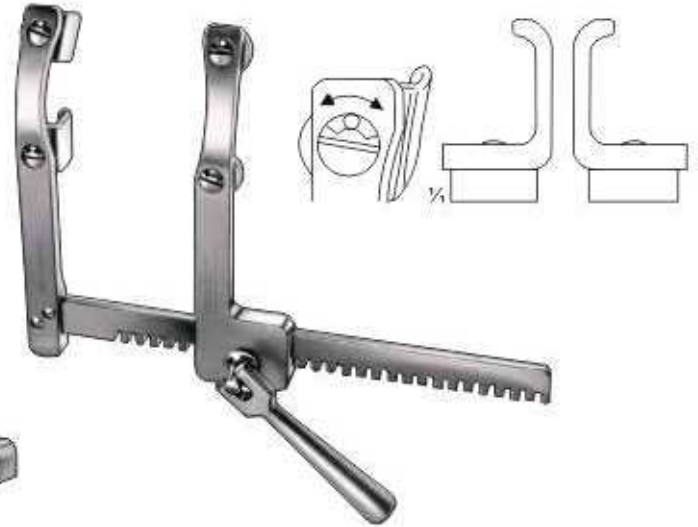

**MORSE-FAVALORO STERNAL RETRACTOR**  
Z-20-243-001  
4 movable blades 17 x 22 mm, spreading 160mm for children



**FINOCCHIETTO (MODIF.)**  
Z-20-244-001  
lateral blades 14 x 15 mm, spreading 120 mm



**TUFFIER RIB RETRACTOR**  
Z-20-245-001  
lateral blades 45 x 45 mm, spreading 160 mm



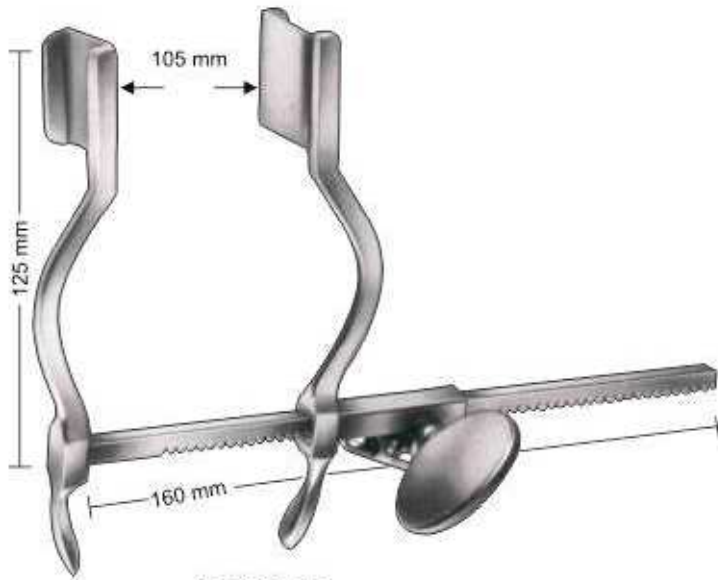

**HERTZLER**  
Z-20-246-001  
blades 20 x 25 mm, spreading 105 mm

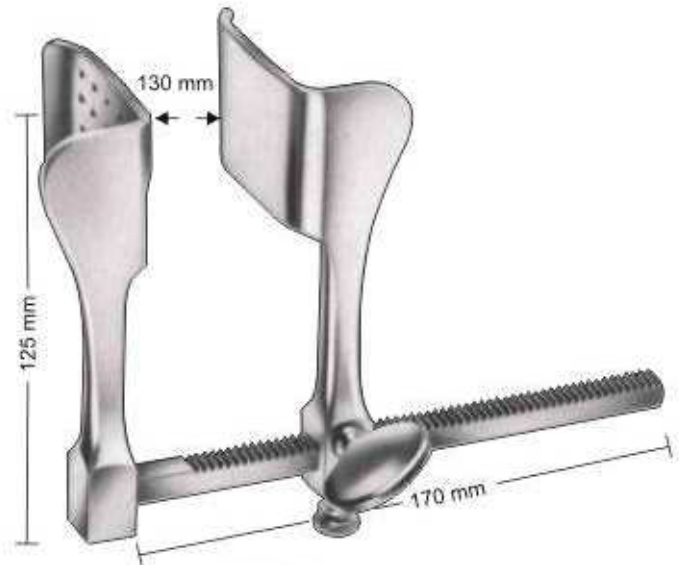

**TUFFIER**  
Z-20-247-001  
blades 43 x 53 mm, spreading 130 mm



**THORACIC RETRACTOR**  
Z-20-248-001 Retractor only  
Z-20-249-002 pair of blades, 48 x 68 mm  
Z-20-250-003 1 pair of blades, 70 x 75 mm



**THORACIC & I.M.A.**  
Z-20-251-001 Complete set  
Z-20-252-002 lateral blades for I.M.A Retractor  
left 40 x 50 x 80 mm  
Z-20-253-003 lateral blades for I.M.A Retractor  
Right 40 x 50 x 80 mm

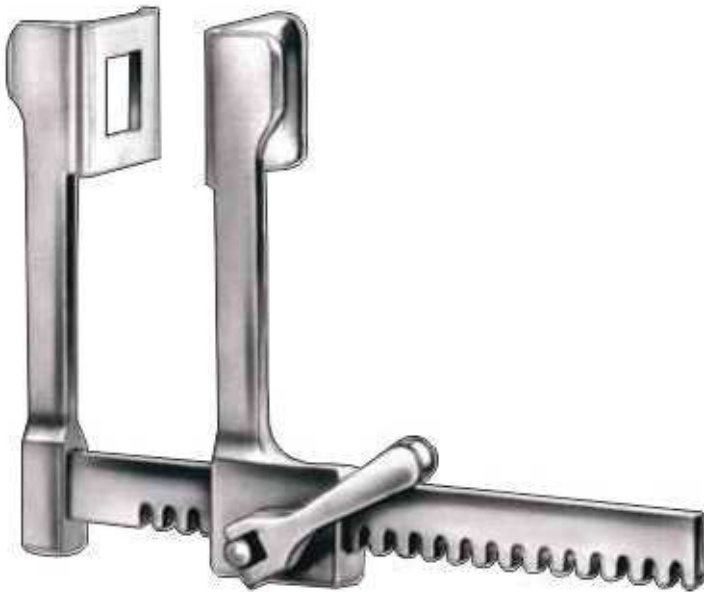

**FINOCCHIETTO/BABY**  
Z-20-254-075  
7.5 cm, 3"  
14 mm x 15 mm spreading 75 mm



**FINOCCHIETTO,**  
Z-20-255-200  
20 cm, 8"  
Z-20-256-001 30 mm x 45 mm spreading 150 mm  
Z-20-257-002 46 mm x 62 mm spreading 190 mm  
Z-20-258-003 80 mm x 65 mm spreading 190 mm

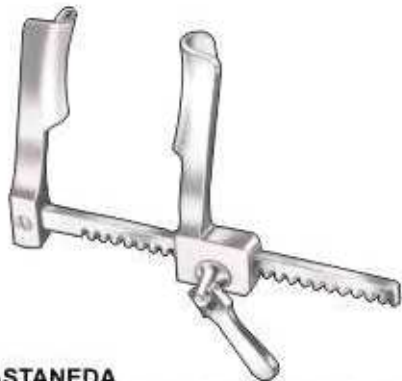

**CASTANEDA**  
Z-20-259-200 10.5 mm x 32 mm spreading 65 mm

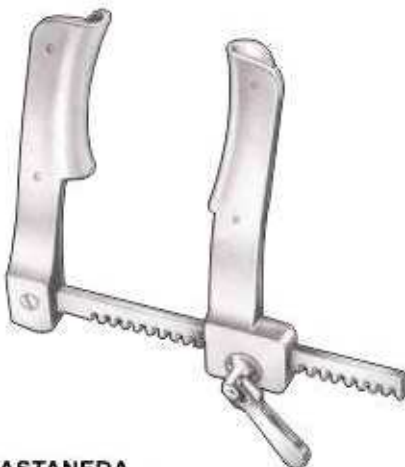

**CASTANEDA**  
Z-20-260-200 12 mm x 45 mm spreading 70 mm



**CASTANEDA**  
Z-20-261-200 15 mm x 60 mm spreading 120 mm



**BURFORD**

**Z-20-262-180**

18 cm, 7, For children  
spread with 2 sets of Blades

**Z-20-263-180**

48 mm x 42 mm spreading 135 mm

**Z-20-264-180**

38 mm x 42 mm spreading 135 mm



**BURFORD**

**Z-20-265-180**

18 cm, 7, For Adults  
spread with 2 sets of Blades

**Z-20-266-001** With two pair of blade 47 x 62 mm + 65 x 62 mm spreading 200 mm

**Z-20-267-002** with 2 pair of blade 47 x 62 mm + 65 x 62 mm spreading 260 mm

**Z-20-268-003** with 2 pair of blade 47 x 62 mm + 65 x 62 mm spreading 300 mm

**RIB SHEARS, STERNUM CHISEL** **ZIANA**  
 INDUSTRIES

Rippenscheren, Sternummeißel  
 Costotomos, Cinceles

Costotomes, ciseau-Burin à sternum  
 Costotomi, Scalpello per sterno



**SAUERBRUCH-FREY**  
 Z-20-269-370  
 for the first rib  
 37 cm, 14 1/2"



**SCHUMACHER**  
 Z-20-270-210  
 sternum shears  
 21 cm, 8 1/4"



**BONE SHEAR**  
 Z-20-271-230  
 23 cm, 9"



**RIB SHEAR**  
 Z-20-272-230  
 23 cm, 9"



**GLUCK RIB SHEAR**  
 Z-20-273-220  
 22 cm, 8 3/4"



**LEBSCHKE STERNUM CHISEL**  
 Z-20-274-245  
 24.5 cm, 9 3/4"

**RIB SHEARS, STERNUM CHISEL**

Rippenscheren, Sternummeißel  
Costotomos, Cinceles

Costotomes, ciseau-Burin à sternum  
Costotomi, Scalpello per sterno



**SEMB**  
Z-20-275-200  
20 cm, 8"



**SEMB**  
Z-20-276-200  
20 cm, 8"



**GIERTZ-STILLE**  
Z-20-277-270  
27 cm, 10 1/2"

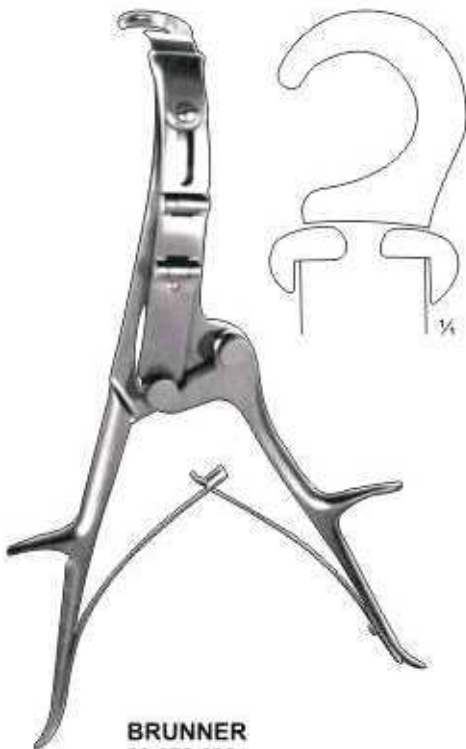

**BRUNNER**  
Z-20-278-335  
33.5 cm, 13"



**MAURER-COLLIN**

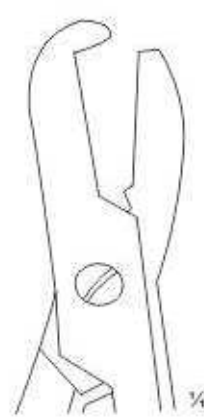

**Z-20-279-230**  
Hooked Left  
23 cm, 9"



**Z-20-280-230**  
Hooked Right  
23 cm, 9"

# RIB SHEARS, STERNUM CHISEL

Rippenscheren, Sternummeißel  
Costotomos, Cinceles

Costotomes, ciseau-Burin à sternum  
Costotomi, Scalpello per sterno



**SAUERBRUCH**  
Z-20-281-240 24 cm, 9 1/2" For Children,  
Z-20-282-270 27 cm, 10 3/4" For Adults,



**SCHUARDT**  
Z-20-283-170  
17 cm, 6 3/4"



**COLLIN**  
Z-20-284-190  
19 cm, 7 1/4"



**DOYEN**  
Z-20-285-190  
19 cm, 7 1/4"



**NABATOFF**  
**Z-20-286-001**  
varicose vein probe  
set complete



**Z-20-287-002**  
Plastic Probe tip



**Z-20-288-003**  
3 mm Ø  
Olive



**Z-20-289-004**  
6 mm Ø  
Olive



**Z-20-290-005**  
9 mm Ø  
Olive



**Z-20-291-006**  
12 mm Ø  
Olive

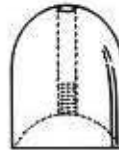

**Z-20-292-007**  
15 mm Ø  
Olive

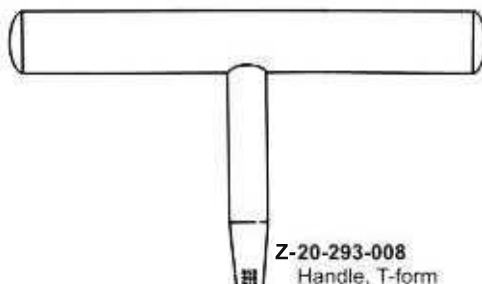

**Z-20-293-008**  
Handle, T-form



**TRACTION CABLE**  
**Z-20-294-900**  
90 cm, 36"

# INTESTINAL AND RECTAL INSTRUMENTS **ZIANA** INDUSTRIES

---

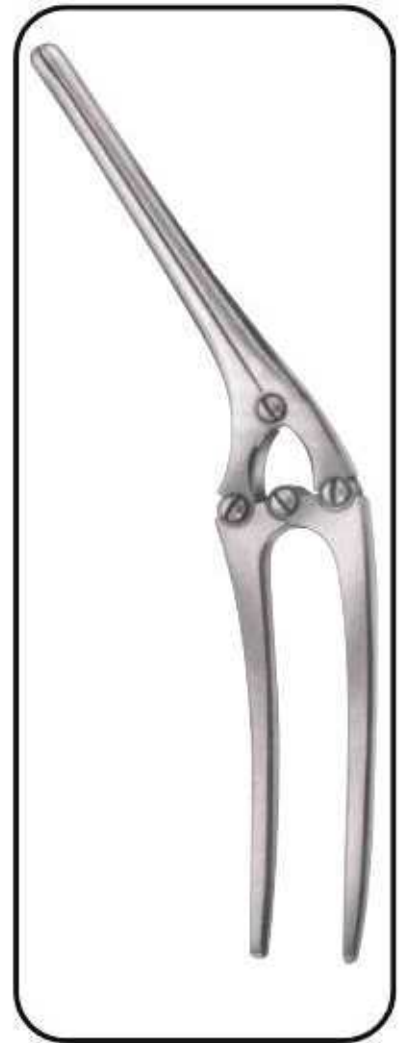
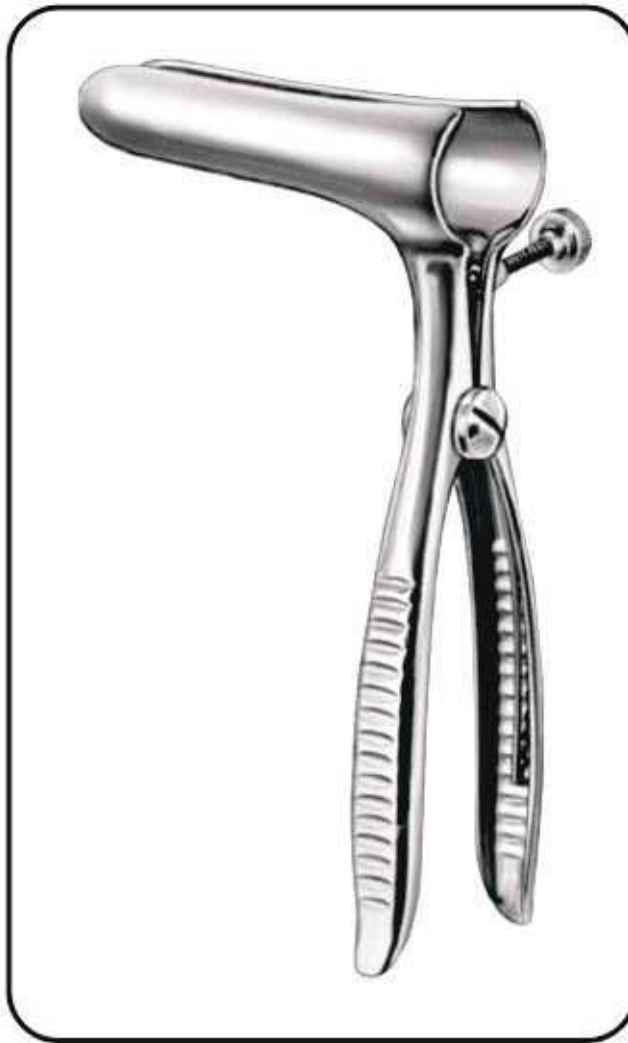



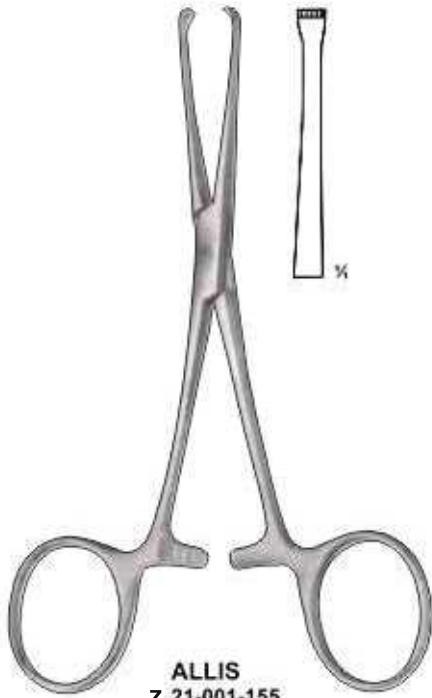

**ALLIS**  
Z-21-001-155  
3 x 4 teeth  
15.5 cm, 6"

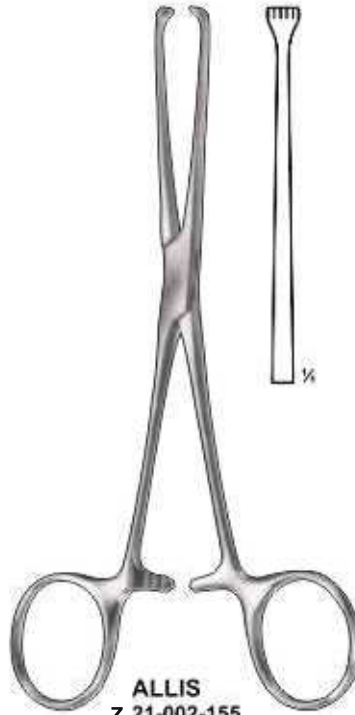

**ALLIS**  
Z-21-002-155  
4 x 5 teeth  
15.5 cm, 6"

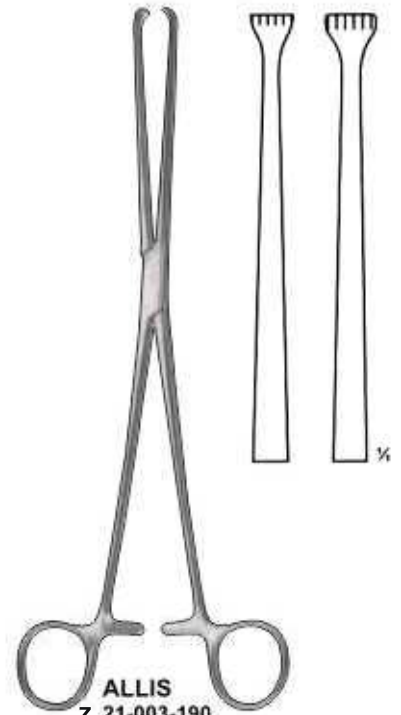

**ALLIS**  
Z-21-003-190  
19.0 cm, 7 1/2"  
Z-21-004-255  
25.5 cm, 10"  
5 x 6 teeth



**JUDD-ALLIS**  
Z-21-005-195  
3 x 4 teeth  
19.5 cm, 7 1/4"



**WILLIAMS**  
Z-21-006-160  
16 cm, 6 1/4"

Darm-und Gewebefasszangen  
Pinzas Para Intestinos y Tejidos

Pinces Pour Saisir Intestins et Tissus  
Pinze Per Afferrare Intestino e Tessuti

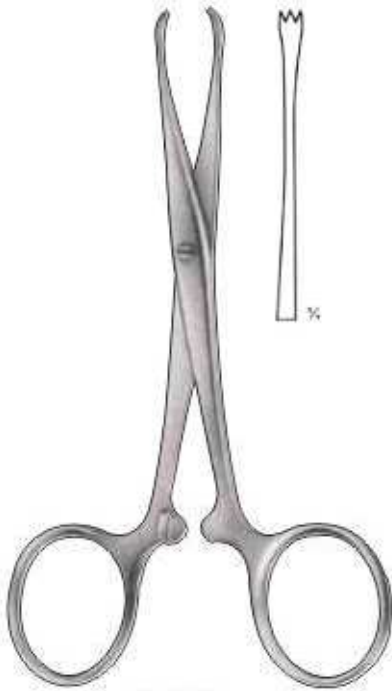

**CHAPUT**  
Z-21-007-125  
2 x 3 teeth, sharp  
12.5 cm, 5"

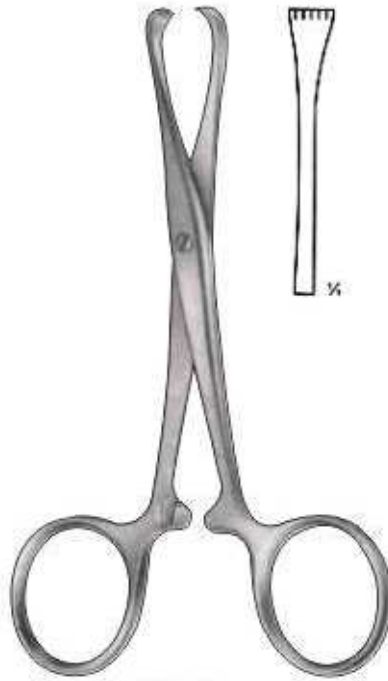

**TUFFIER**  
Z-21-008-125  
5 x 6 teeth, sharp  
12.5 cm, 5"

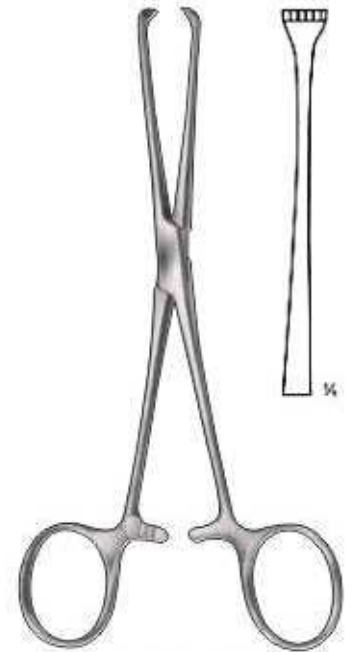

**BOYS-ALLIS**  
Z-21-009-155  
5 x 6 teeth, sharp  
15.5 cm, 6"

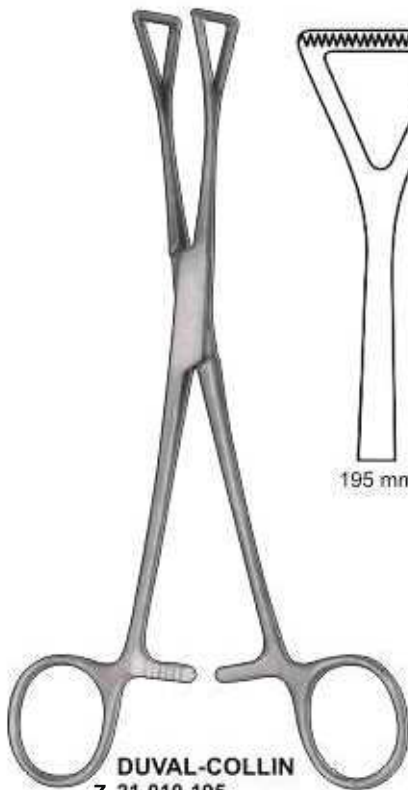

**DUVAL-COLLIN**  
Z-21-010-195  
19.5 cm, 7 3/4"  
Z-21-011-200  
20.0 cm, 8"

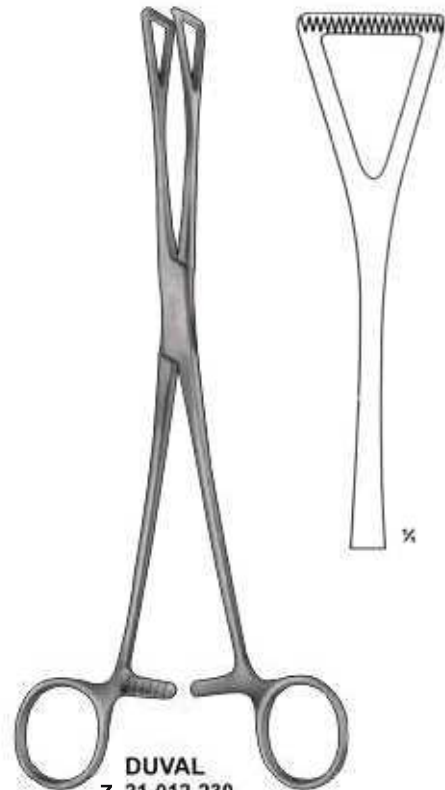
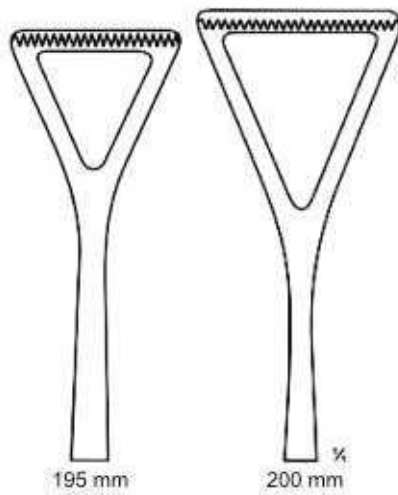

**DUVAL**  
Z-21-012-230  
23.0 cm, 9"

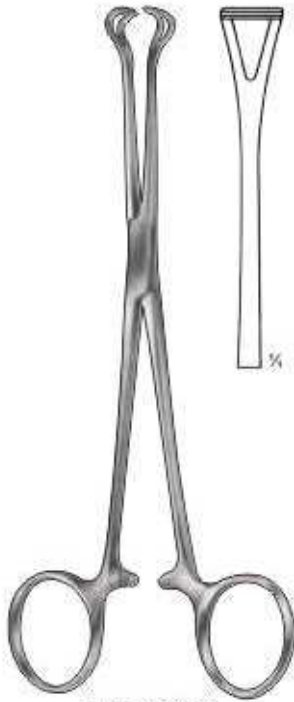

**BABCOCK**  
Z-21-013-155  
15.5 cm, 6"



**BABCOCK**

Z-21-014-170  
17.0 cm, 6 3/4"

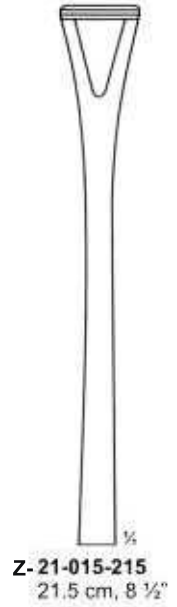

Z-21-015-215  
21.5 cm, 8 1/2"

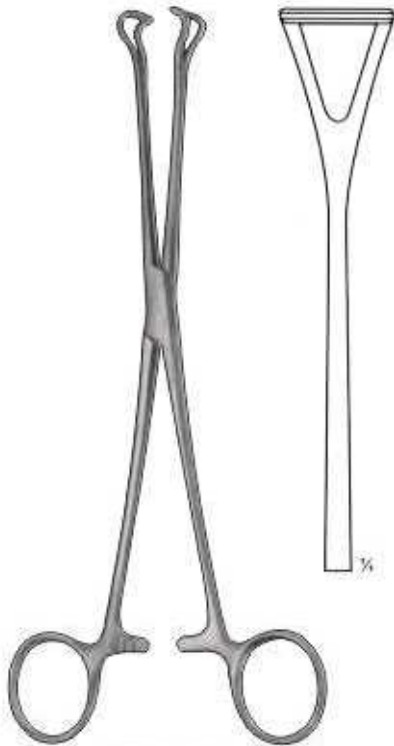

**BABCOCK**  
Z-21-016-220  
22.0 cm, 8 3/4"

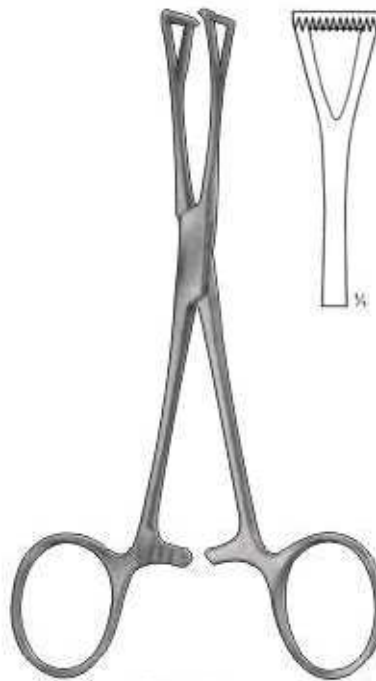

**COLLIN**  
Z-21-017-140  
14.0 cm, 5 1/2"

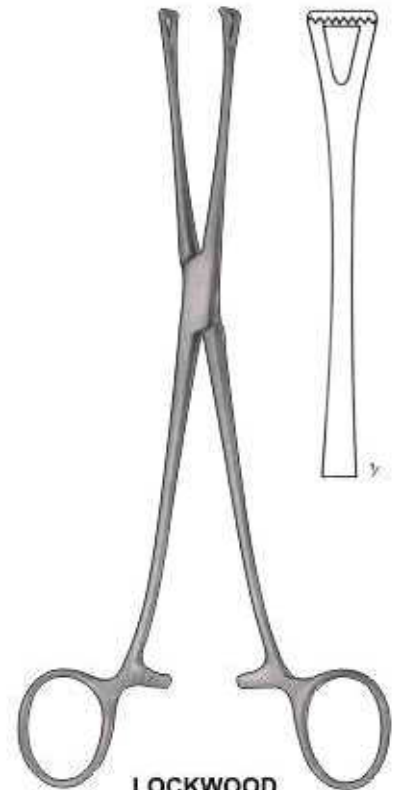

**LOCKWOOD**  
Z-21-018-200  
20.0 cm, 8"

**INTESTINAL & TISSUE GRASPING FORCEPS**

Darm- und Gewebefassungen  
Pinzas Para Intestinos y Tejidos

Pinces Pour Saisir Intestins et Tissus  
Pinze Per Afferrare Intestino e Tessuti



**ALLIS**

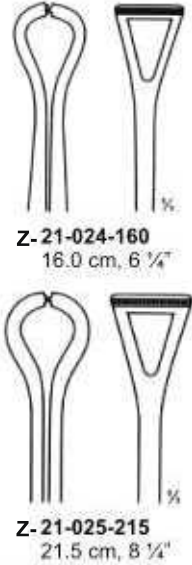
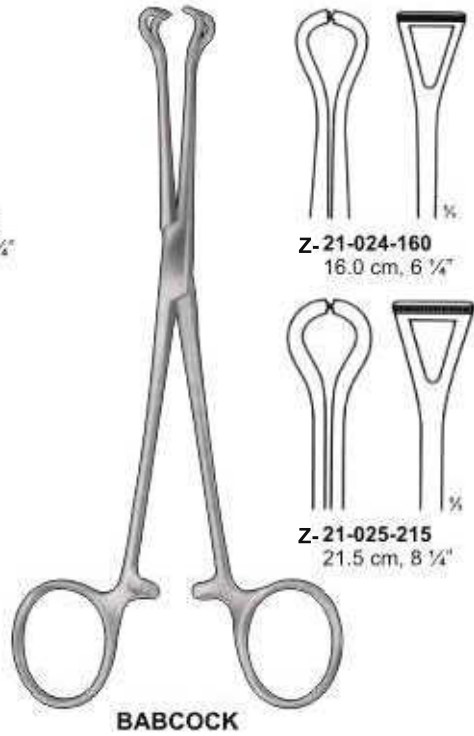
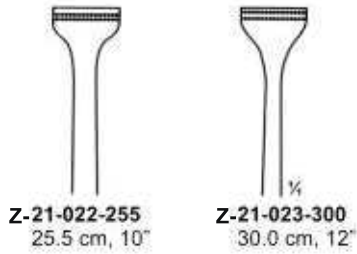
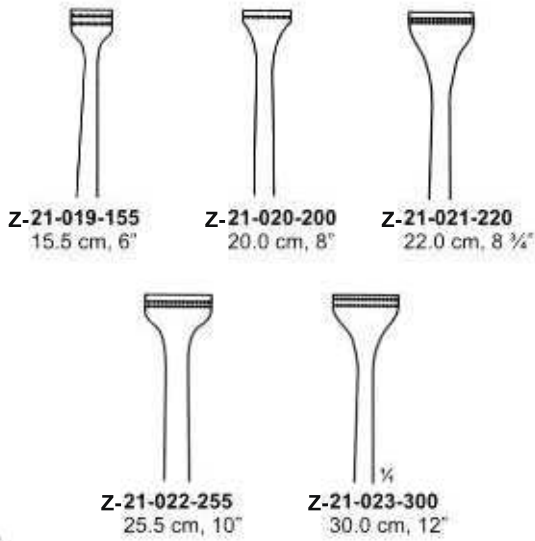

**COLLIN**  
Z-21-026-195  
19.5 cm, 7 3/4"

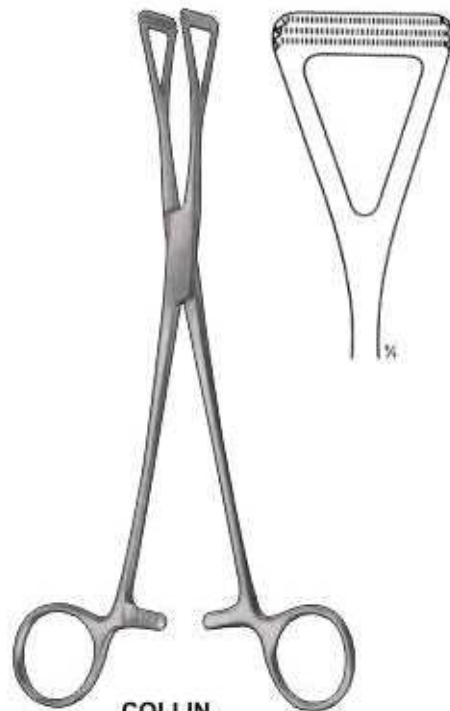

**COLLIN**  
Z-21-027-230  
23.0 cm, 9"

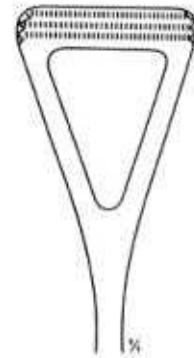



**BABCOCK**

- Z-21-028-160 16 cm, 6 ¼"
- Z-21-029-180 18 cm, 7"
- Z-21-030-240 24 cm, 9 ½"



**LANE**

- Z-21-031-127 12.7 cm, 5"
- Z-21-032-150 15 cm, 6"
- Z-21-033-190 19 cm, 7 ½"



**LITTLE WOOD TISSUE  
FORCEPS**  
Z-21-034-190  
19 cm, 7 ½" Box Joint

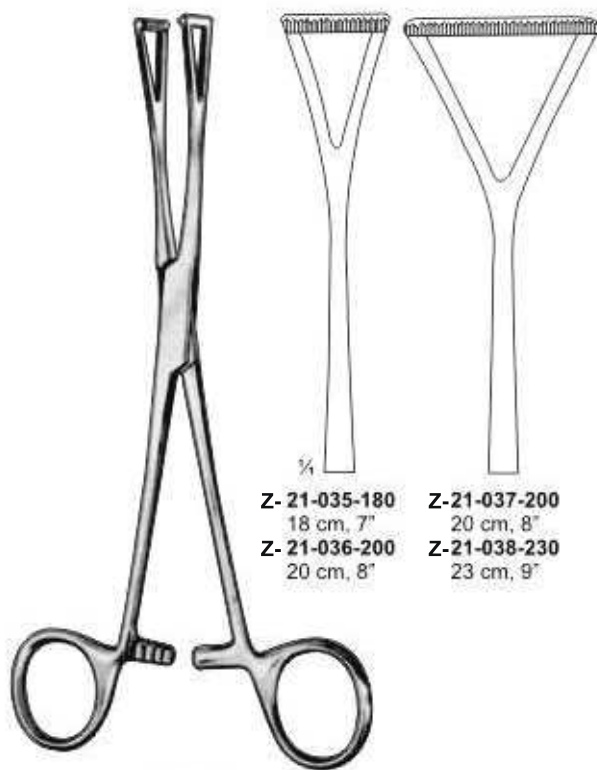

**DUVAL**

- Z-21-035-180 18 cm, 7"
- Z-21-036-200 20 cm, 8"
- Z-21-037-200 20 cm, 8"
- Z-21-038-230 23 cm, 9"

Darmklemmen  
 Pinzas Intestinales

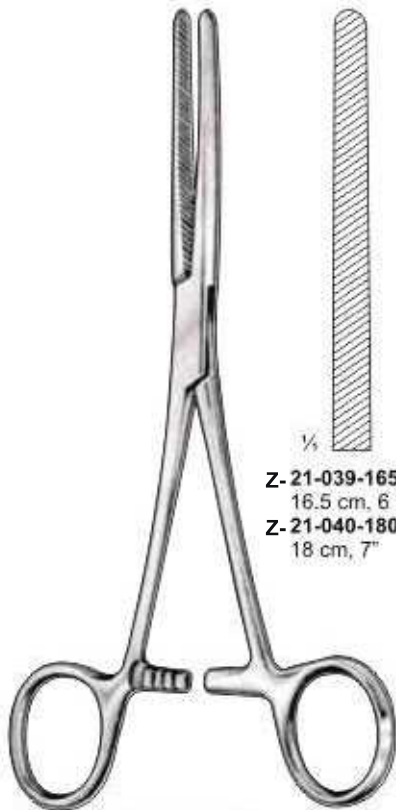

Z-21-039-165  
 16.5 cm, 6 1/2"  
 Z-21-040-180  
 18 cm, 7"

**BABY-DOYEN**



Z-21-041-165  
 16.5 cm, 6 1/2"  
 Z-21-042-180  
 18 cm, 7"

**MAYO-ROBSON**

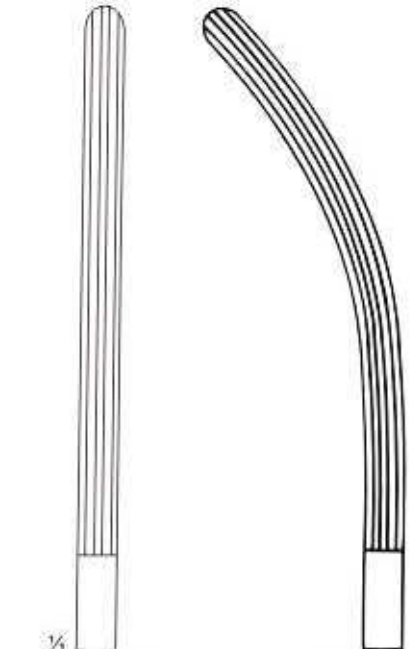

Z-21-043-210  
 21 cm, 8 1/4"  
 Z-21-044-230  
 23 cm, 9"  
 Z-21-045-250  
 25 cm, 10"

Z-21-046-210  
 21 cm, 8 1/4"  
 Z-21-047-230  
 23 cm, 9"  
 Z-21-048-250  
 25 cm, 10"

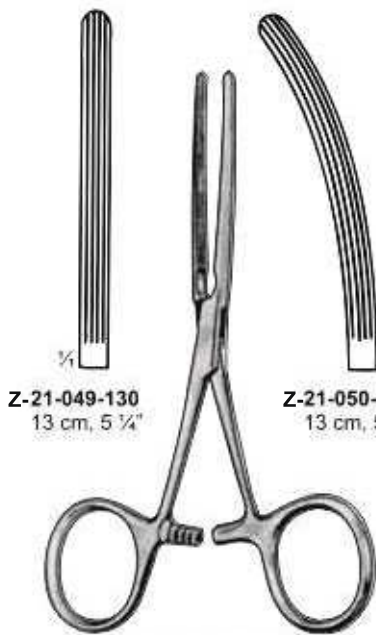

Z-21-049-130  
 13 cm, 5 1/4"

Z-21-050-130  
 13 cm, 5 1/4"

**BABY-KOCHER**



Z-21-051-220  
 22 cm, 8 3/4"  
 Straight

**KOCHER**



Z-21-052-210  
 21 cm, 8 1/4"  
 Z-21-053-230  
 23 cm, 9"  
 straight,  
 grooved

**DOYEN**

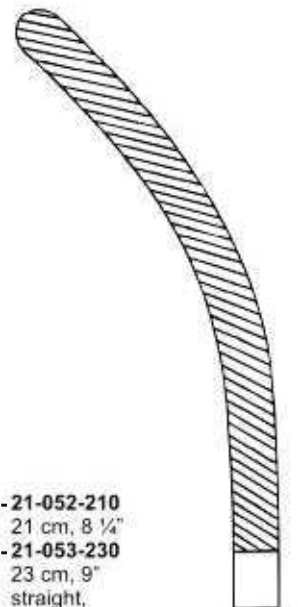

Z-21-054-220  
 22 cm, 8 3/4"  
 Curved,  
 grooved

## POLYOUS GRASPING FORCEPS, ANASTOMOSIS

*Polypenfasszange, Darm-anastomosenklemmen*

*Pinza Para Coger Pólipos, Clamps Para Anastomosis Intestinales*

*Pince Pour Saisir Polypes, Pinces-clamps Pour Anastomose Intestinale*

*Pinze Per Afferrare Polipi, Pinze Per Anastomosi Intestinali*

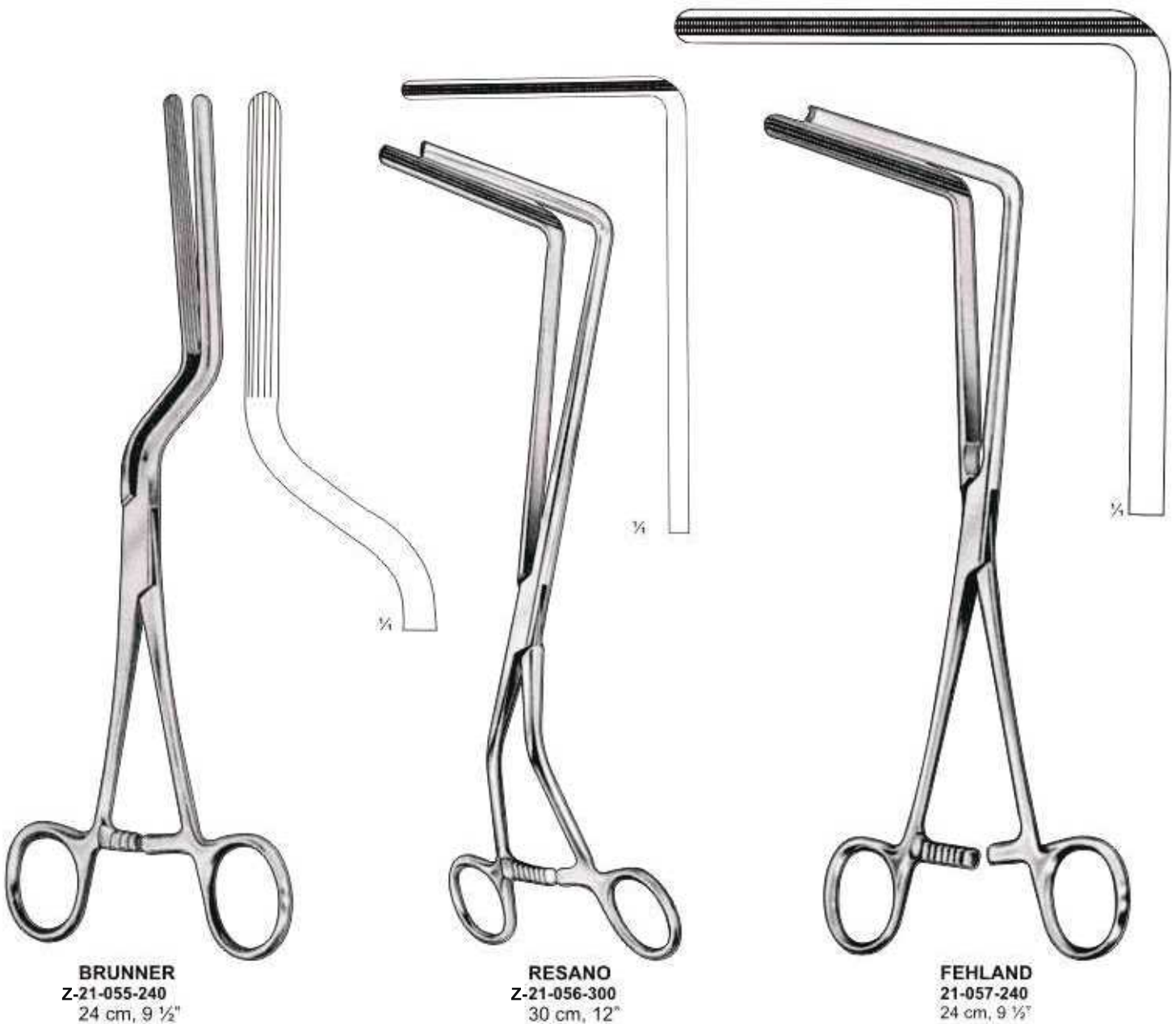

Darmklemmen  
 Pinzas Intestinales

Pinces Intestinales  
 Pinze Intestinali



**BAINBRIDGE**

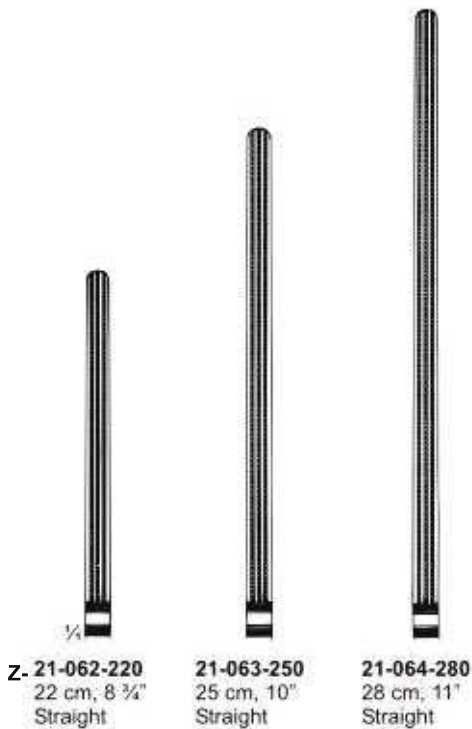

**KOCHER**







**DOYEN**



**Z-21-068-130**  
13 cm, 5 1/4"



**Z-21-069-160**  
16 cm, 6 1/4"



**Z-21-070-180**  
18 cm, 7"

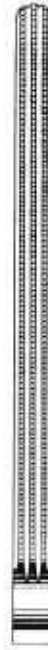

**Z-21-071-210**  
21 cm, 8 1/4"

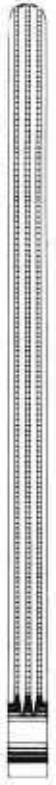

**Z-21-072-230**  
23 cm, 9"



**DOYEN**



**Z-21-073-130**  
13 cm, 5 1/4"



**21-074-160**  
16 cm, 6 1/4"



**21-075-180**  
18 cm, 7"



**21-076-210**  
21 cm, 8 1/4"



**21-077-230**  
23 cm, 9"

*Darmklemmen*  
*Pinzas Intestinales*



**NUSSBAUM**

**Z- 21-078-250**  
 25 cm, 10"

**Z- 21-079-250**  
 25 cm, 10"



**SCUDDER**

**Z- 21-080-250**  
 25 cm, 10"  
**Z- 21-081-330**  
 33 cm, 13"

**Z- 21-082-250**  
 25 cm, 10"  
**Z- 21-083-330**  
 33 cm, 13"

# POLYOUS GRASPING FORCEPS, ANASTOMOSIS

*Polyphenfasszange, Darm-anastomosenklemmen*

*Pinza Para Coger Pólipos, Clamps Para Anastomosis Intestinales*

*Pince Pour Saisir Polypes, Pinces-clamps Pour Anastomose Intestinale*

*Pinze Per Afferrare Polipi, Pinze Per Anastomosi Intestinali*

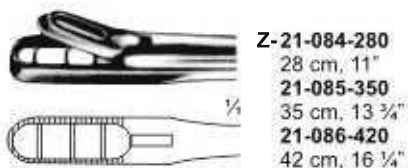
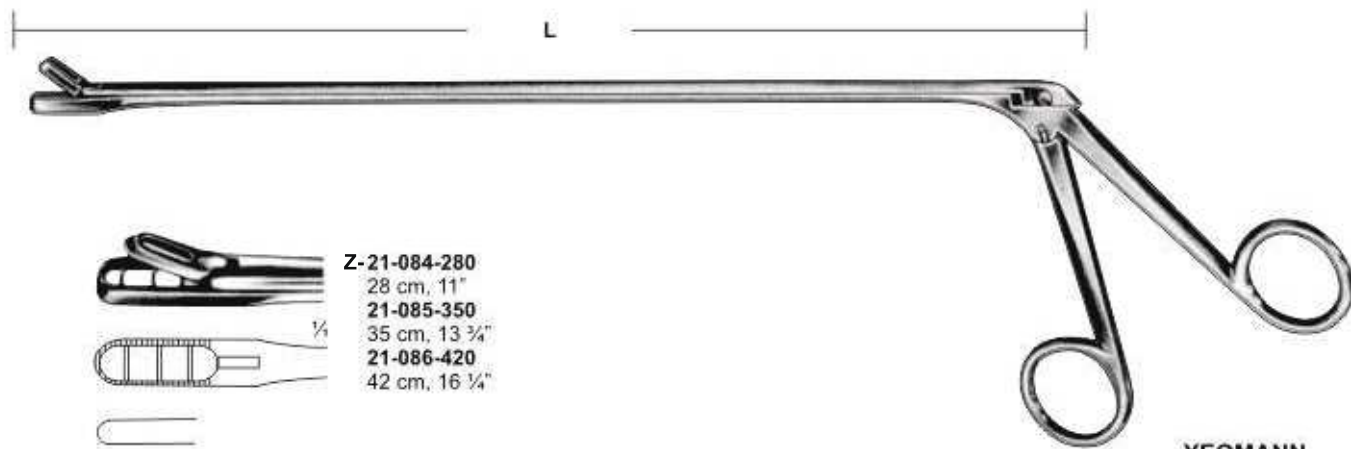

**Z-21-084-280**

28 cm, 11"

**21-085-350**

35 cm, 13 3/4"

**21-086-420**

42 cm, 16 1/4"

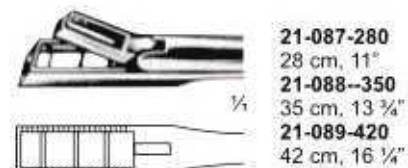

**21-087-280**

28 cm, 11"

**21-088-350**

35 cm, 13 3/4"

**21-089-420**

42 cm, 16 1/4"

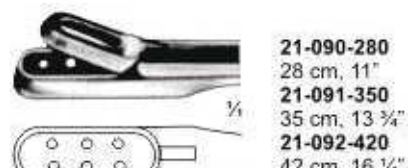

**21-090-280**

28 cm, 11"

**21-091-350**

35 cm, 13 3/4"

**21-092-420**

42 cm, 16 1/4"

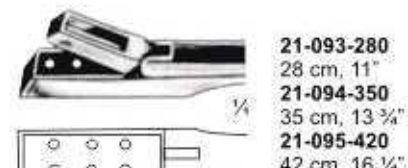

**21-093-280**

28 cm, 11"

**21-094-350**

35 cm, 13 3/4"

**21-095-420**

42 cm, 16 1/4"



**POLYOUS GRASPING FORCEPS, ANASTOMOSIS**

Polypenfasszange, Darm-anastomosenklemmen  
Pinza Para Coger Pólipos, Clamps Para Anastomosis Intestinales

Pince Pour Saisir Polypes, Pincés-clamps Pour Anastomose Intestinale  
Pinze Per Afferrare Polipi, Pinze Per Anastomosi Intestinali



**Z-21-096-085**  
8.5 cm, 3 1/4"



**DE MARTEL-WOLFSON**  
**21-097-230**  
23 cm, 9"



**DE MARTEL-WOLFSON**  
set of 3  
anastomosis clamps



Jaw length  
**Z-21-098-050**  
5 cm, 2"



Jaw length  
**21-099-070**  
7 cm, 2 3/4"



Jaw length  
**21-100-100**  
10 cm, 4"

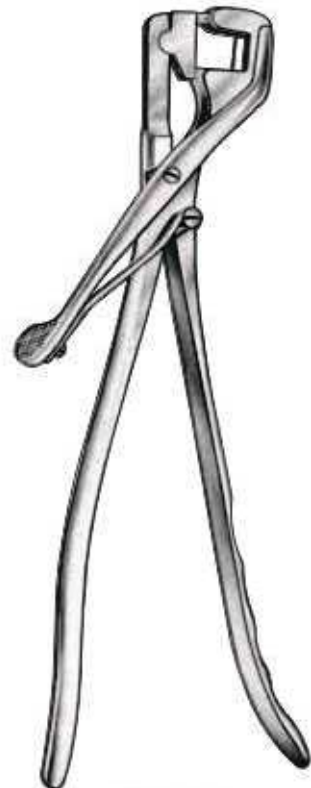

**DE MARTEL-WOLFSON**  
**21-101-260**  
26 cm, 10 1/4"



**PAYR-BABY**  
Z-21-102-150  
15 cm, 6"  
without pin  
21-103-150  
15 cm, 6"  
with pin

**PAYR**  
21-104-210  
21 cm, 8 1/4"  
without pin  
21-105-210  
21 cm, 8 1/4"  
with pin

**PAYR**  
21-106-290  
29 cm, 11 1/2"  
without pin  
21-107-290  
29 cm, 11 1/2"  
with pin

**PAYR**  
21-108-350  
35 cm, 13 3/4"  
without pin  
21-109-350  
35 cm, 13 3/4"  
with pin

Darmklemmen  
Pinzas Intestinales

Pincas Intestinales  
Pinze Intestinali



**LANE Str.**  
**Z11-110-300**  
30 cm, 12"

**LANE Cvd.**  
**Z11-111-300**  
30 cm, 12"

**Intestinal & Stomach Twin Clamp Forceps**

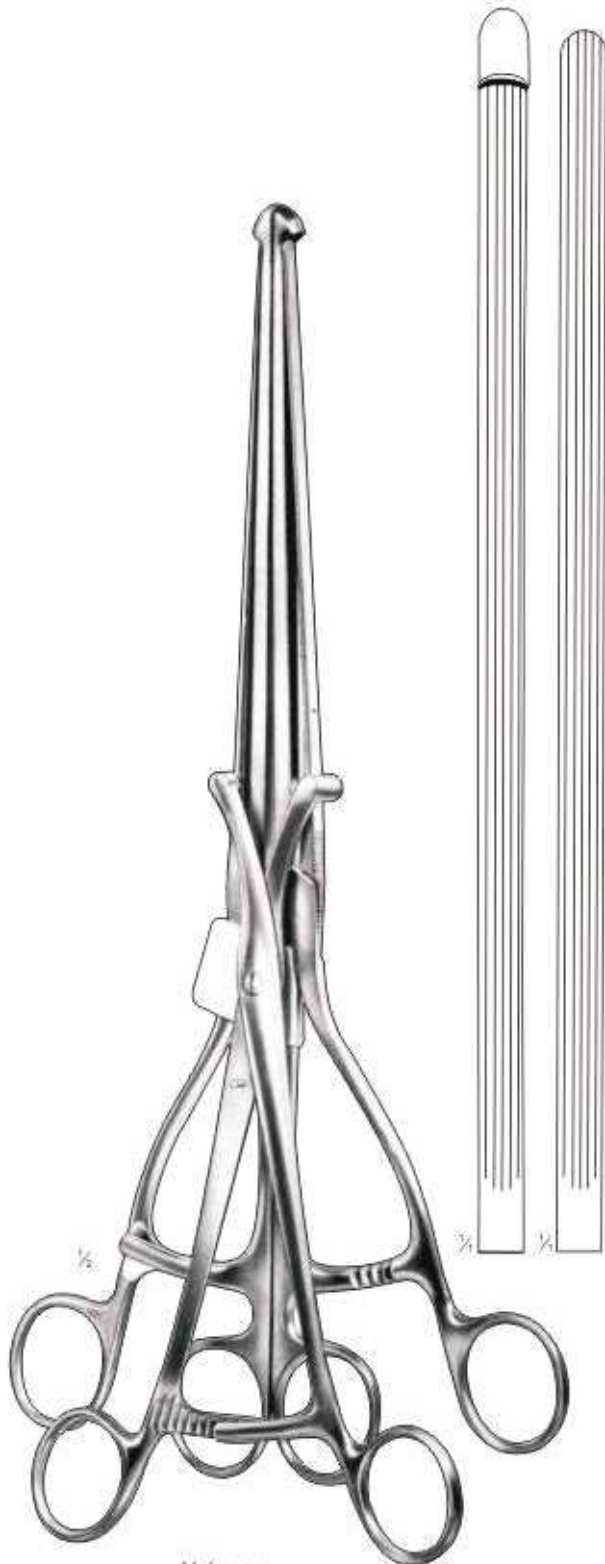

Haberer  
Z- 21-112-36  
36cm 14"

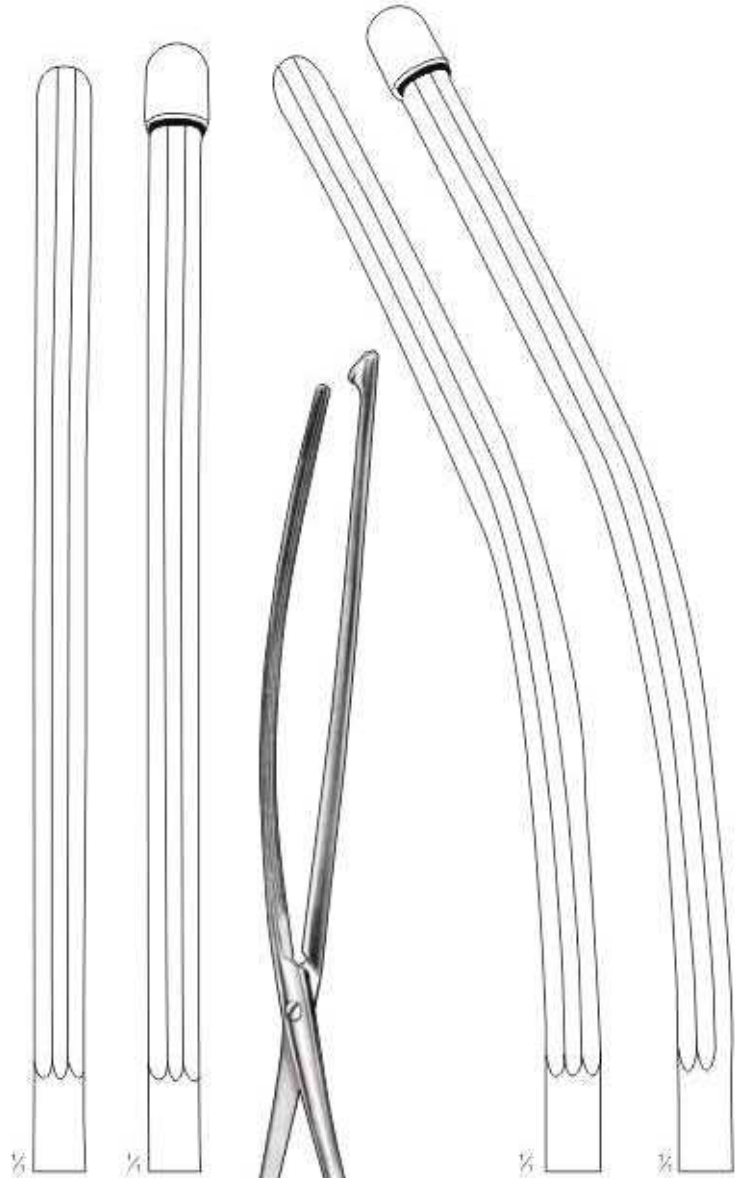

21-113-30

21-114-30

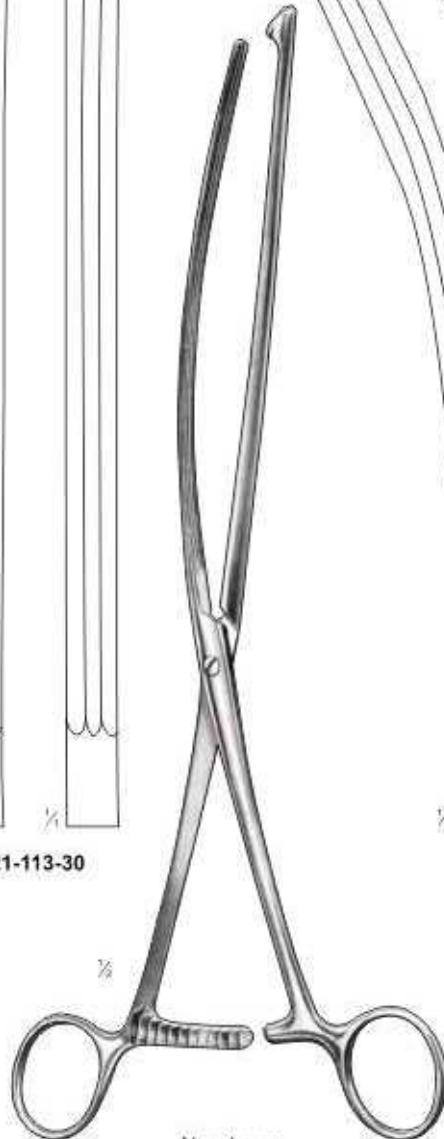

Nussbaum  
30cm 12"

Darmklemmen  
Pinzas Intestinales

**Intestinal Twin Clamp Forceps**

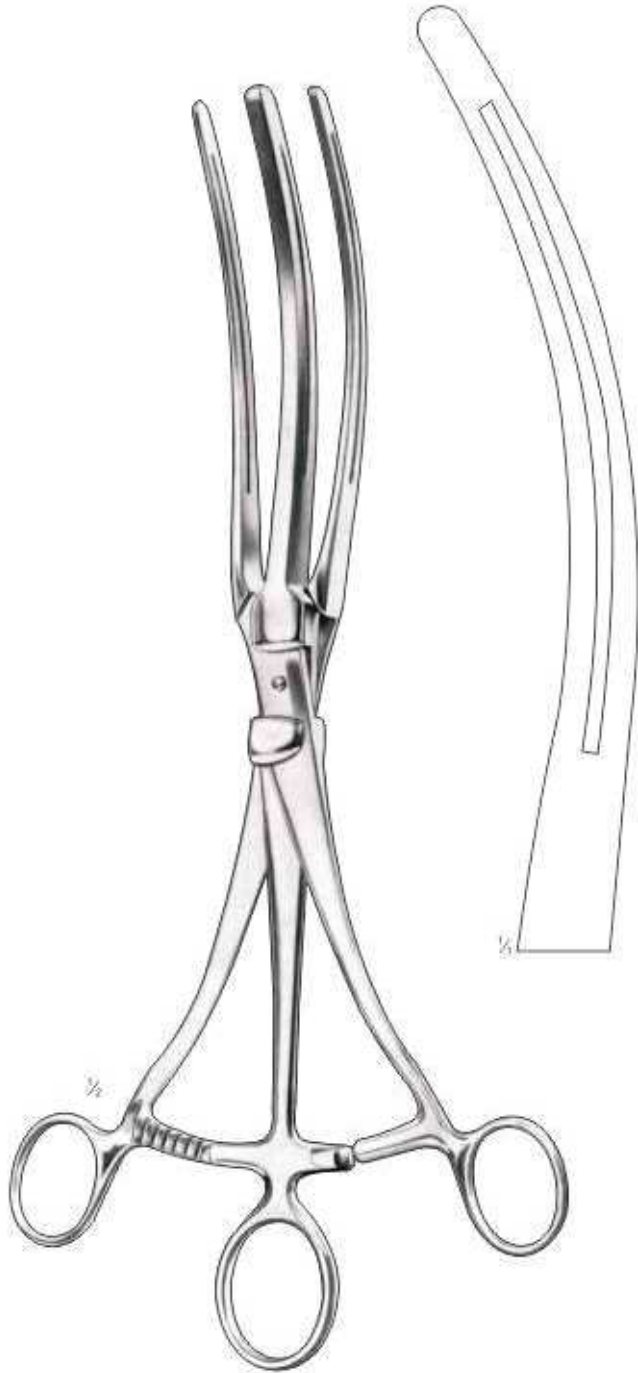

Roosevelt  
Z-21-115-34  
34cm 13 1/2"

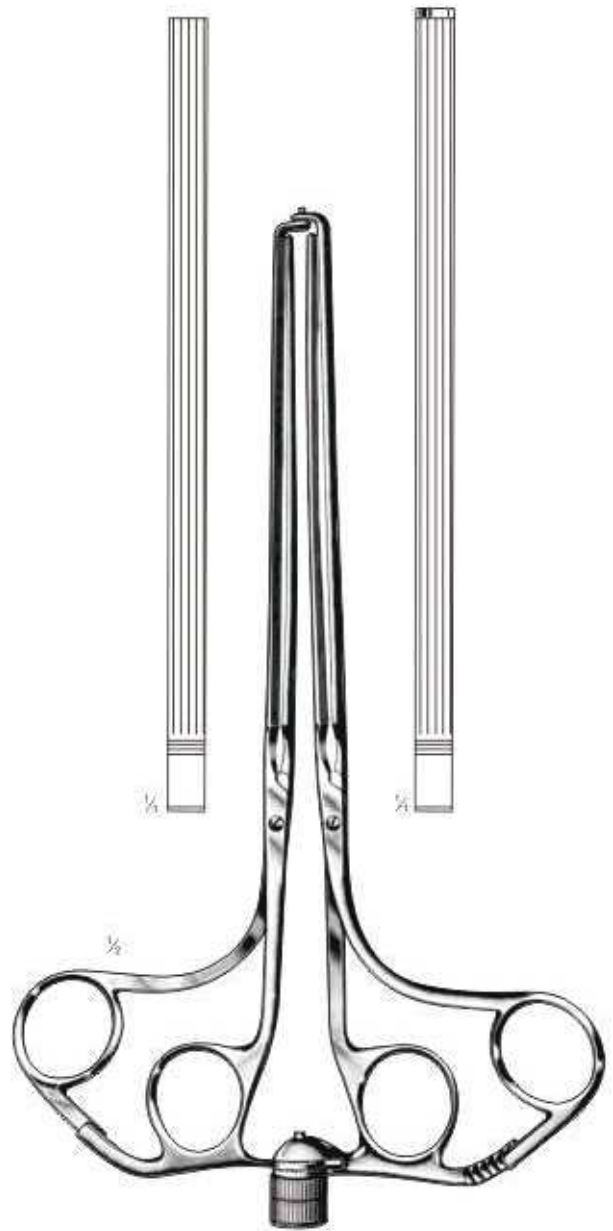

Abadie  
Z-21-116-22  
22cm 8 3/4"  
Z-21-117-27  
27cm 10 1/2"





90 x 15 mm

**MATHIEU**  
Z-21-118-195  
19.5 cm, 7 3/4"  
90 x 15 mm



**SIMS**  
Z-21-119-150  
15 cm, 6"



**SIMS**  
Z-21-120-150  
15 cm, 6"



**BARR**  
Z-21-121-001  
Blade size  
80 mm



**IVES-FANSLER**  
Z-21-122-154  
14.5 mm, 5 3/4"  
22 mm Ø



**PRATT**  
Z-21-123-215  
21.5 cm, 8 1/2"  
85 x 25 mm blade

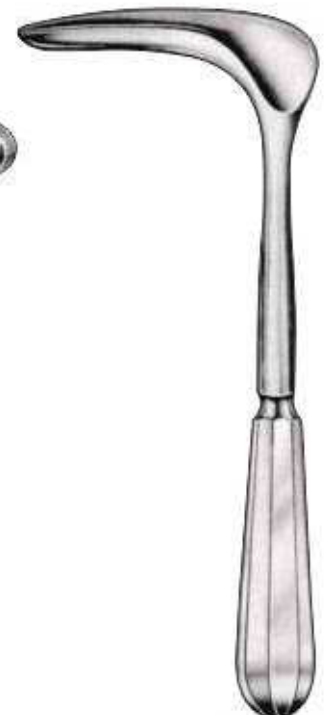

**CZERNY**  
Z-21-124-220  
22 cm, 8 3/4"

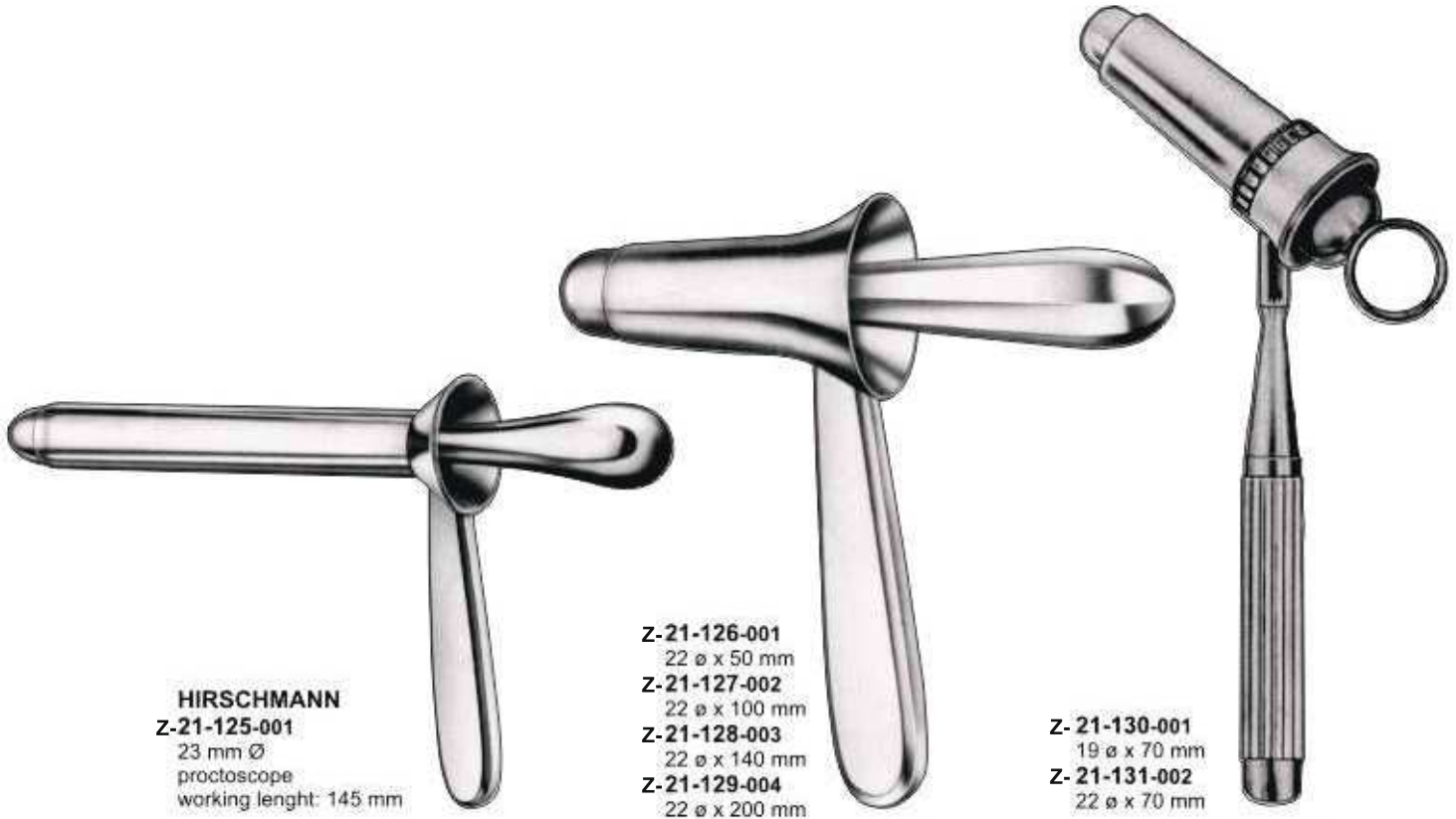

**HIRSCHMANN**  
**Z-21-125-001**  
 23 mm Ø  
 proctoscope  
 working length: 145 mm

**Z-21-126-001**  
 22 ø x 50 mm  
**Z-21-127-002**  
 22 ø x 100 mm  
**Z-21-128-003**  
 22 ø x 140 mm  
**Z-21-129-004**  
 22 ø x 200 mm

**Z-21-130-001**  
 19 ø x 70 mm  
**Z-21-131-002**  
 22 ø x 70 mm

**KELLY**

**BENSAUDE**

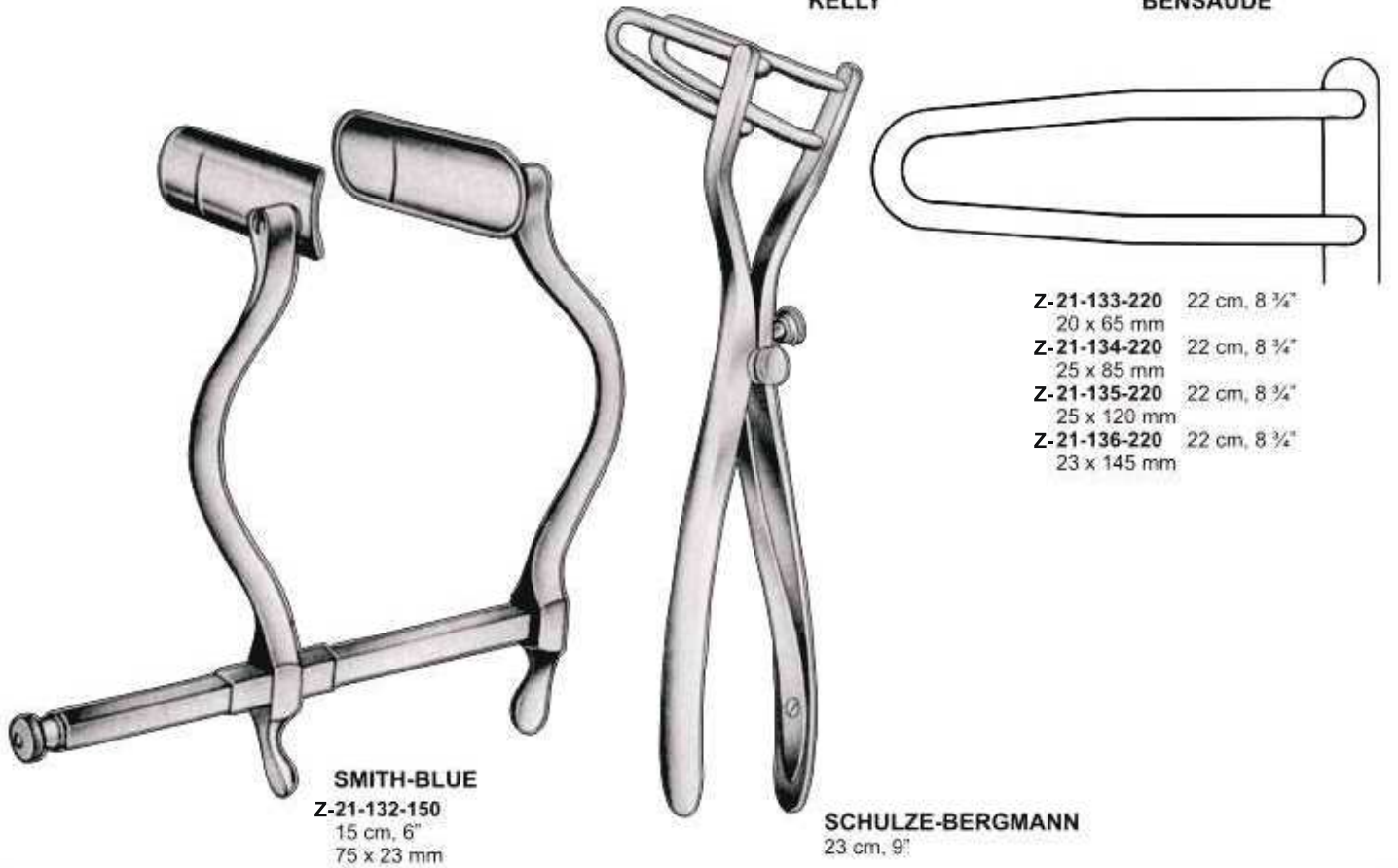

**SMITH-BLUE**  
**Z-21-132-150**  
 15 cm, 6"  
 75 x 23 mm

**SCHULZE-BERGMANN**  
 23 cm, 9"

**Z-21-133-220** 22 cm, 8 3/4"  
 20 x 65 mm  
**Z-21-134-220** 22 cm, 8 3/4"  
 25 x 85 mm  
**Z-21-135-220** 22 cm, 8 3/4"  
 25 x 120 mm  
**Z-21-136-220** 22 cm, 8 3/4"  
 23 x 145 mm

# INTESTINAL & TISSUE GRASPING FORCEPS

Darm-und Gewebefasszangen  
Pinzas Para Intestinos y Tejidos

Pinces Pour Saisir Intestins et Tissus  
Pinze Per Afferrare Intestino e Tessuti

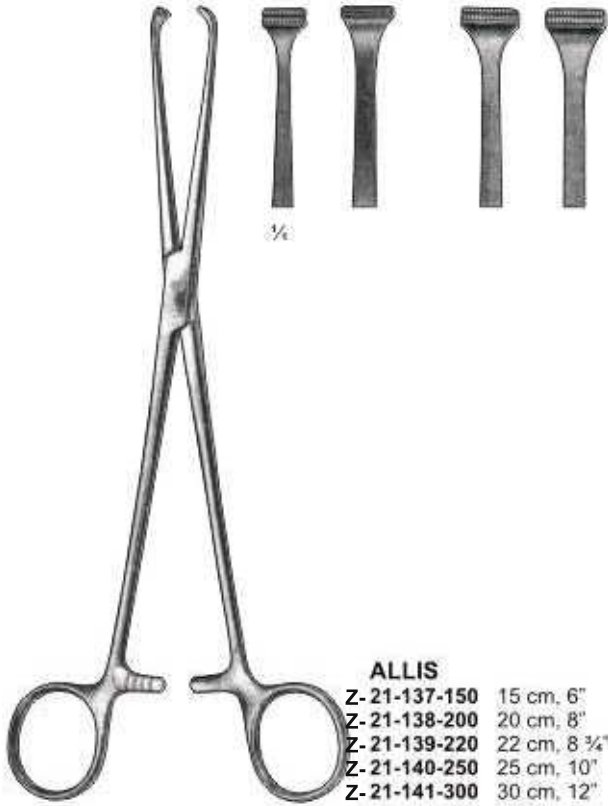

**ALLIS**

- Z-21-137-150 15 cm, 6"
- Z-21-138-200 20 cm, 8"
- Z-21-139-220 22 cm, 8 3/4"
- Z-21-140-250 25 cm, 10"
- Z-21-141-300 30 cm, 12"

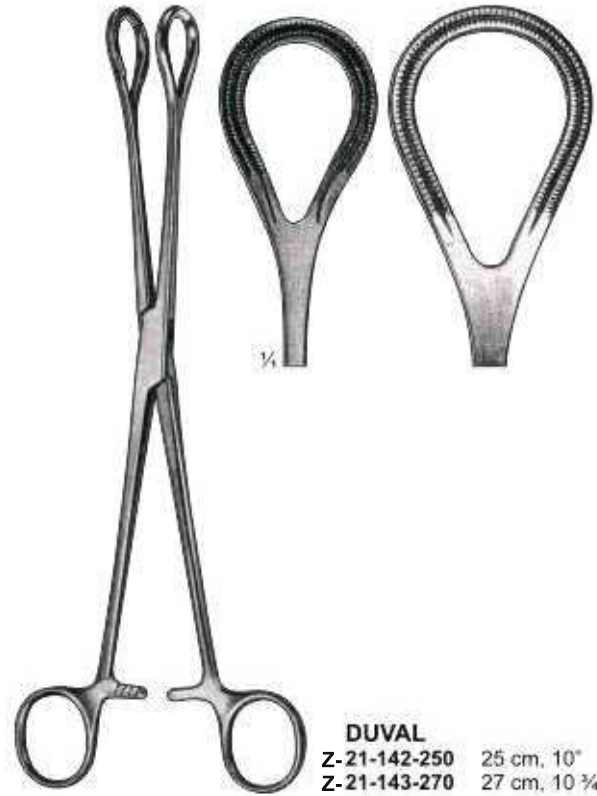

**DUVAL**

- Z-21-142-250 25 cm, 10"
- Z-21-143-270 27 cm, 10 3/4"

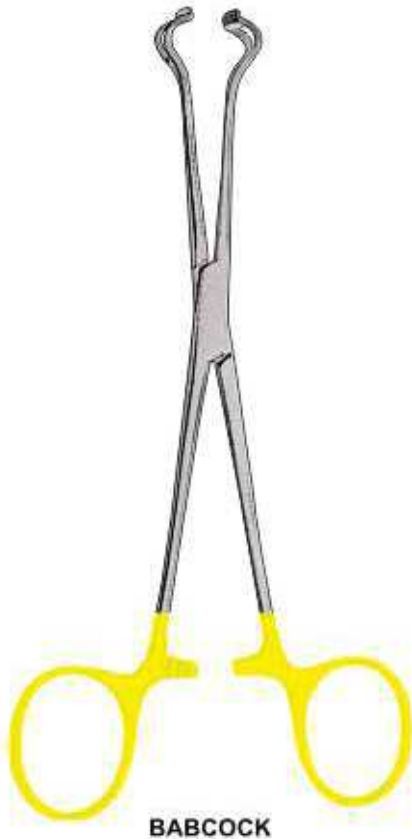

**BABCOCK**



- Z-21-144-165 16.5 cm, 6 1/2"
- Z-21-145-203 20.3 cm, 8"

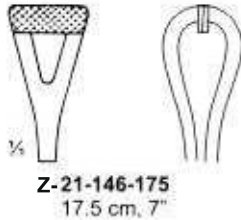

- Z-21-146-175 17.5 cm, 7"



- Z-21-147-195 19.5 cm, 8"



**DUVAL**



- Z-21-148-130 13 cm, 5 1/4"

- Z-21-149-180 18 cm, 7"

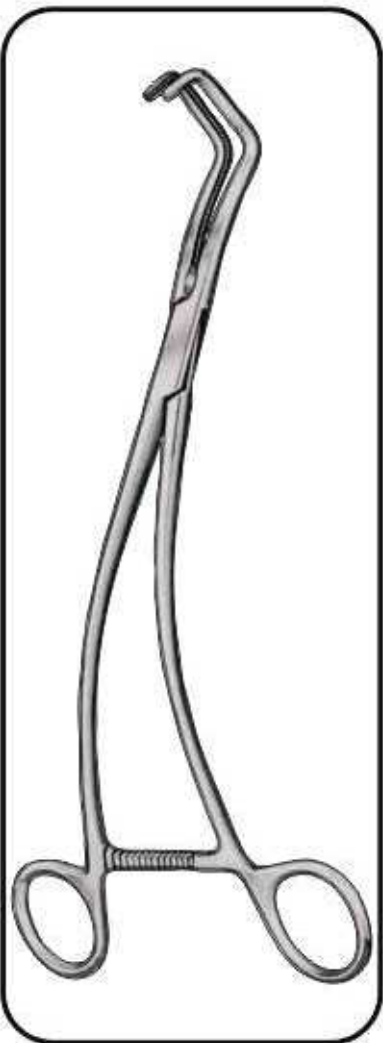

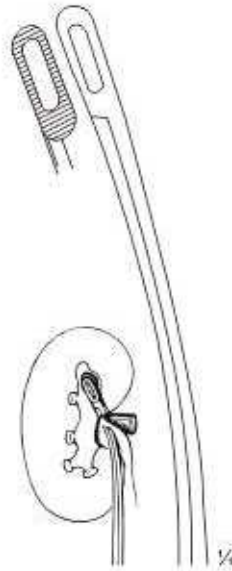

**Z-22-001-230**  
23 cm, 9"

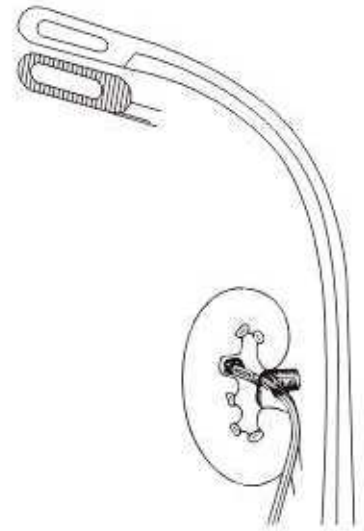

**Z-22-002-230**  
23 cm, 9"

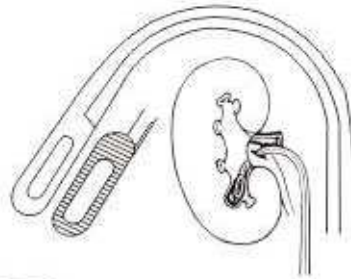

**Z-22-003-230**  
23 cm, 9"

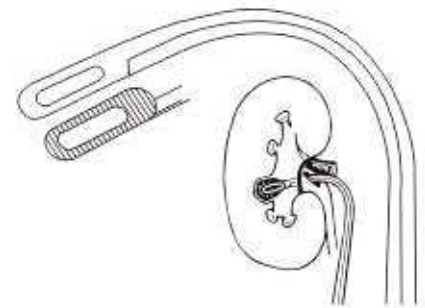

**Z-22-004-230**  
23 cm, 9"

Nierensteinzangen  
Pinzas para cálculoa renales

Pinces pour les calculs du bassin  
Pinze per calcoli renali



**DARTIGUES**  
Z-22-005-270  
27 cm, 10 1/4"



**COLLIN**  
Z-22-006-285  
28.5 cm, 11 1/4"



**HULKA-KENWICK**  
Uterine Elevating &  
Manipulating Forceps  
Z-22-007-273  
27.3 cm, 11"



**SOMER**  
Z-22-008-235  
23.5 cm, 9"



**STRASSMANN**  
Z-22-009-260  
26 cm, 10 1/4"



**COLLIN**  
Z-22-010-265  
26.5 cm, 10 1/4"



Z-22-011-260  
26 cm, 10 1/4"

**PROSTATIC RETRACTOR**

Prostatahaken  
Separadores para próstata

Ecarteurs prostatiques  
Divaricatori prostatici

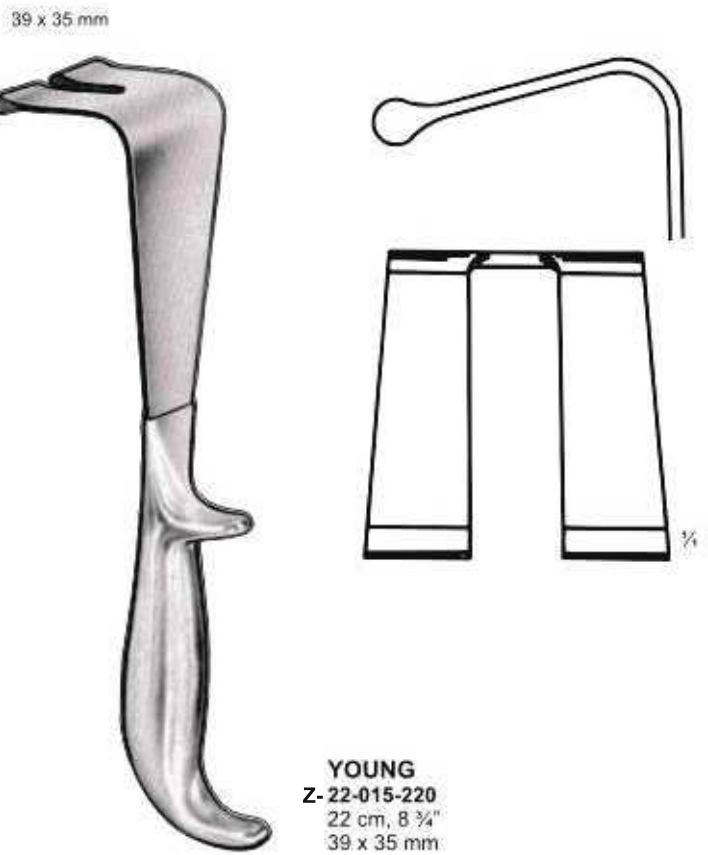
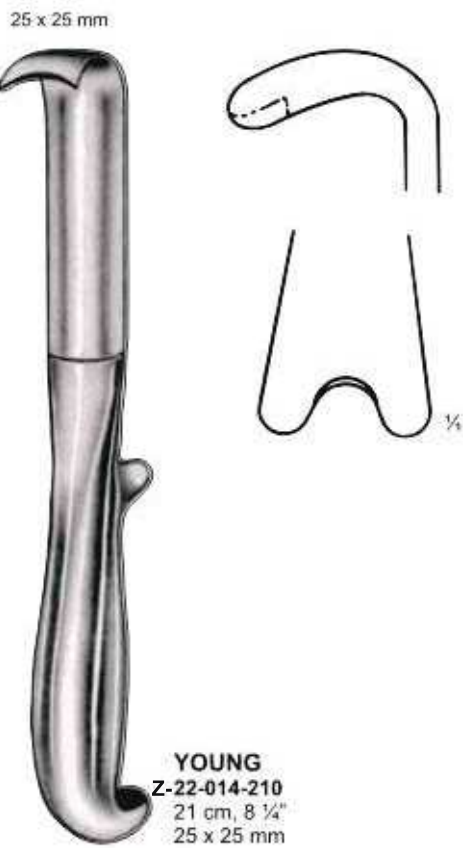
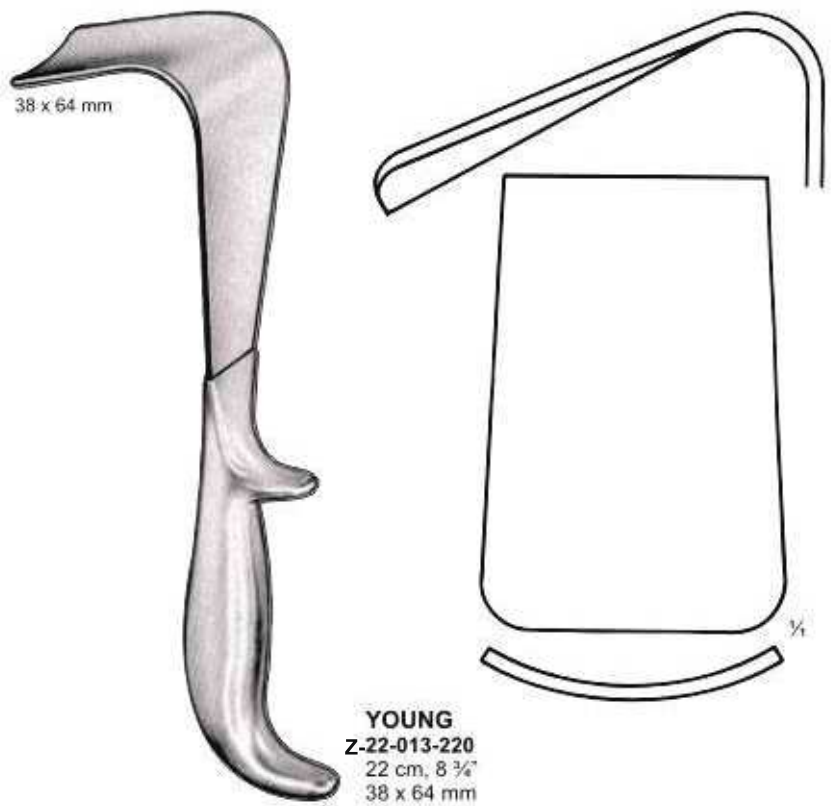
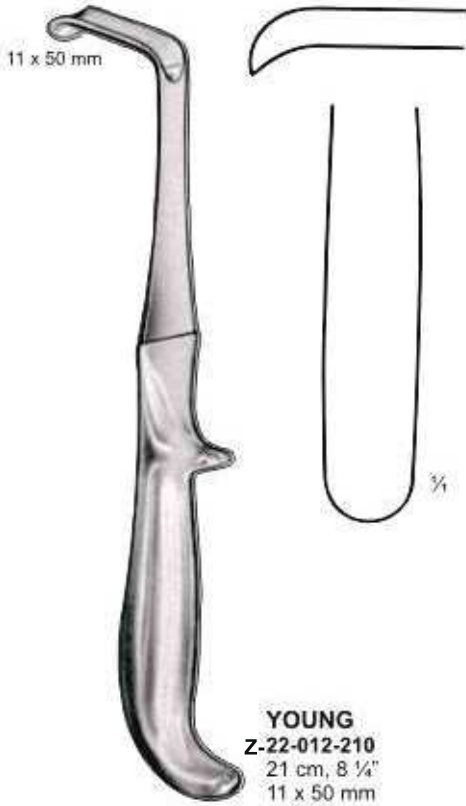

# GALL DUCT DILATOR

Gallenkanaldilatatoren  
Gallensteinzangen

Dilatateurs pour les voies biliaires  
Pinces pour calculs biliaires



Z-22-016-280  
17 F.G.

Z-22-017-280  
21 F.G.

Z-22-018-280  
24 F.G.

Z-22-019-280  
27 F.G.

28 cm, 11"



**MOYNIHAN** **DESJARDINS**  
Z-22-020-340 Z-22-021-280  
34.0 cm, 13 1/2" 28.0 cm, 11"

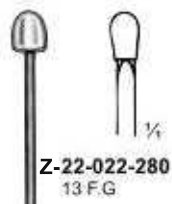

Z-22-022-280  
13 F.G.

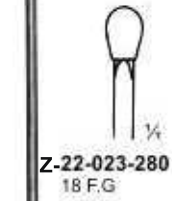

Z-22-023-280  
18 F.G.

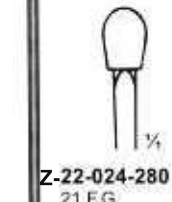

Z-22-024-280  
21 F.G.



**BAKES**  
Set of 13  
32 cm, 13"

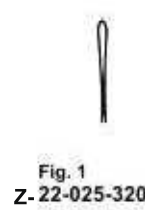

Fig. 1  
Z-22-025-320

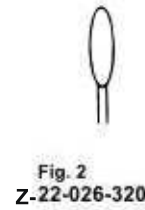

Fig. 2  
Z-22-026-320

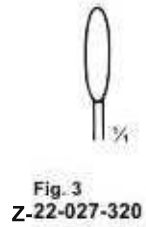

Fig. 3  
Z-22-027-320



Fig. 4  
Z-22-028-320



Fig. 5  
Z-22-029-320

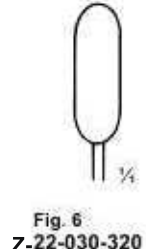

Fig. 6  
Z-22-030-320

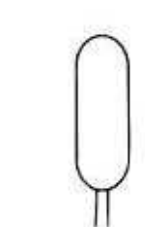

Fig. 7  
Z-22-031-320

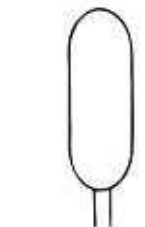

Fig. 8  
Z-22-032-320

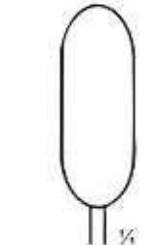

Fig. 9  
Z-22-033-320



Fig. 10  
Z-22-034-320



Fig. 11  
Z-22-035-320



Fig. 12  
Z-22-036-320



Fig. 13  
Z-22-037-320





**CATHETER**  
Z-22-038-150  
15 cm, 6"  
No. 6-16



**CATHETERS**  
22-039-290 29 cm, 11 1/2"  
Male Catheters charr., Metal  
French

Z-22-040-01	8
Z-22-041-02	10
Z-22-042-03	12
Z-22-043-04	14
Z-22-044-05	16
Z-22-045-06	18
Z-22-046-07	20



**LISTER BOUGIES**  
Z-22-047-270  
27 cm, 10 3/4"  
00 / 1 to 15 / 18  
set of 17



**CLUTTON BOUGIES**  
Z-22-048-270 27 cm, 10 3/4"  
06 / 10 FG to 28 / 32  
set of 12



**VAN BUREN**  
A TO O  
Set of 15

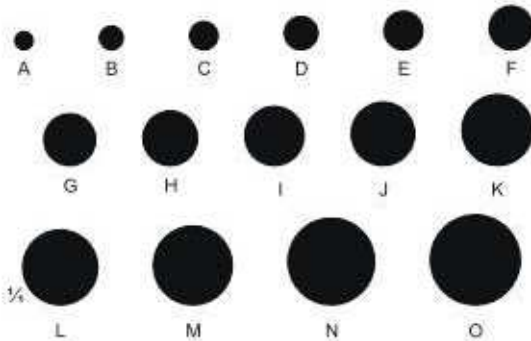

Fig.	Item	Description	Inches	Dia. Charr
A	22-049-280	28 cm	11"	8 French
B	22-050-280	28 cm	11"	10 French
C	22-051-280	28 cm	11"	12 French
D	22-052-280	28 cm	11"	14 French
E	22-053-280	28 cm	11"	16 French
F	22-054-280	28 cm	11"	18 French
G	22-055-280	28 cm	11"	20 French
H	22-056-280	28 cm	11"	22 French
I	22-057-280	28 cm	11"	24 French
J	22-058-280	28 cm	11"	26 French
K	22-059-280	28 cm	11"	28 French
L	22-060-280	28 cm	11"	30 French
M	22-061-280	28 cm	11"	32 French
N	22-062-280	28 cm	11"	34 French
O	22-063-280	28 cm	11"	36 French



**GUYON**  
Z-22-064-001  
420 x 175 x 40 mm  
Set in metal case containing:  
— 21 Bougies Guyon  
— 6 filiform Bougies

Urethalkatheter  
 Sondes Urétrales



	Charr. (French)
Z-22-066-008	8
Z-22-067-009	9
Z-22-068-010	10
Z-22-069-011	11
Z-22-070-012	12
Z-22-071-013	13
Z-22-072-014	14
Z-22-073-015	15
Z-22-074-016	16
Z-22-075-017	17
Z-22-076-018	18
Z-22-077-019	19
Z-22-078-020	20
Z-22-079-021	21
Z-22-080-022	22
Z-22-081-023	23
Z-22-082-024	24
Z-22-083-025	25
Z-22-084-026	26
Z-22-085-027	27
Z-22-086-028	28
Z-22-087-029	29
Z-22-088-030	30

**DITTEL**

Z-22-065-225  
 22.5 cm, 8 3/4"  
 urethral bougies and  
 dilating sounds



	Charr. (French)
Z-22-090-008	8
Z-22-091-009	9
Z-22-092-010	10
Z-22-093-011	11
Z-22-094-012	12
Z-22-095-013	13
Z-22-096-014	14
Z-22-097-015	15
Z-22-098-016	16
Z-22-099-017	17
Z-22-100-018	18
Z-22-101-019	19
Z-22-102-020	20
Z-22-103-021	21
Z-22-104-022	22
Z-22-105-023	23
Z-22-106-024	24
Z-22-107-025	25
Z-22-108-026	26
Z-22-109-027	27
Z-22-110-028	28
Z-22-111-029	29
Z-22-112-030	30

**DITTEL**

Z-22-089-350  
 35 cm, 14"  
 urethral bougies and  
 dilating sounds



	Charr. (French)
Z-22-114-330	3
Z-22-115-330	4
Z-22-116-330	5
Z-22-117-330	6

**Z-22-113-330**

33 cm, 13"  
 filiform guides,  
 olive tip



	Charr. (French)
Z-22-119-008	Ben. 24 / Charr. 12
Z-22-120-009	Ben. 25
Z-22-121-010	Ben. 26 / Charr. 13
Z-22-122-011	Ben. 27
Z-22-123-012	Ben. 28 / Charr. 14
Z-22-124-013	Ben. 29
Z-22-125-014	Ben. 30 / Charr. 15
Z-22-126-015	Ben. 31
Z-22-127-016	Ben. 32 / Charr. 16
Z-22-128-017	Ben. 33
Z-22-129-018	Ben. 34 / Charr. 17
Z-22-130-019	Ben. 35
Z-22-131-020	Ben. 36 / Charr. 18
Z-22-132-021	Ben. 37
Z-22-133-022	Ben. 38 / Charr. 19
Z-22-134-023	Ben. 39
Z-22-135-024	Ben. 40 / Charr. 20
Z-22-136-025	Ben. 41
Z-22-137-026	Ben. 42 / Charr. 21
Z-22-138-027	Ben. 43
Z-22-139-028	Ben. 44 / Charr. 22
Z-22-140-029	Ben. 45
Z-22-141-030	Ben. 46 / Charr. 23
Z-22-142-031	Ben. 47
Z-22-143-032	Ben. 48 / Charr. 24
Z-22-144-033	Ben. 49
Z-22-145-034	Ben. 50 / Charr. 25
Z-22-146-035	Ben. 51
Z-22-147-036	Ben. 52 / Charr. 26
Z-22-148-037	Ben. 53
Z-22-149-038	Ben. 54 / Charr. 27
Z-22-150-039	Ben. 55
Z-22-151-040	Ben. 56 / Charr. 28
Z-22-152-041	Ben. 57
Z-22-153-042	Ben. 58 / Charr. 29
Z-22-154-043	Ben. 59
Z-22-155-044	Ben. 60 / Charr. 30

**GUYON**

Z-22-118-250  
 25 cm, 10"  
 urethral bougies and  
 dilating sounds  
 without filiform guides,  
 with thread in tip

# GALL STONE FORCEPS

Gallensteinzangen  
Gallensteinlöffel

Pinces pour calculs biliaires  
Curettes pour calculs biliaires



**BLAKE**  
Z-22-156-200 20 cm, 8"



**BLAKE**  
Z-22-157-200 20 cm, 8"



**MAYO-BLAKE**  
Z-22-158-200 20 cm, 8"



**MAYO-BLAKE**  
Z-22-159-200 20 cm, 8"



**URO-TANGENTIAL**

Z-22-160-260  
26 cm, 10 1/4"



Z-22-161-260  
26 cm, 10 1/4"



**MIXTER**  
Z-22-162-220 22 cm, 8 1/2"



**DESJARDINS**  
Z-22-163-230 23 cm, 9"



**DESJARDINS**  
Z-22-164-230 23 cm, 9"

**CAPSULE FORCEPS, LIGATURE CARRYING FORCEPS**

Kapselfasszangen, Fadenführungszange  
Pinzas capsulares, Pinza porta ligaduras

Pinces pour saisir les capsules, Pince porte-fil  
Pinze per afferrare capsule, Pinza porta-filo

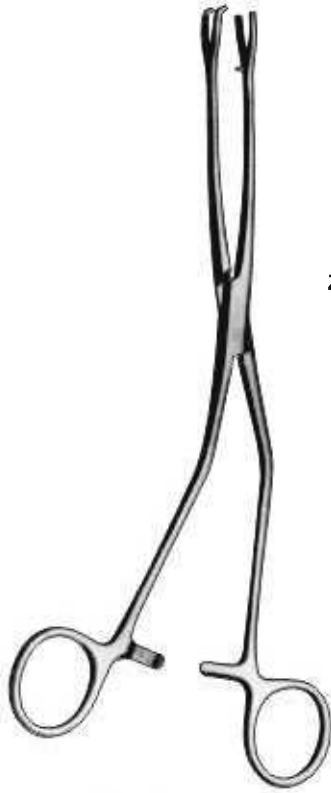

**HARRIS**  
Angled Suture

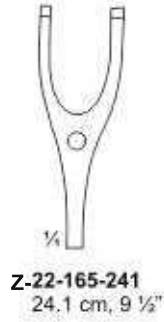

**Z-22-165-241**  
24.1 cm, 9 1/2"



**JOHNSON PROSTATIC**  
NEEDLE HOLDER



**Z-22-166-292**  
29.2 cm, 12"



**Z-22-167-230**  
23 cm, 9"



**MILLIN**  
Z-22-168-240  
24 cm, 9 1/2"



**MILLIN**  
Z-22-169-230  
23 cm, 9"



**MILLIN**  
Z-22-170-230  
23 cm, 9"

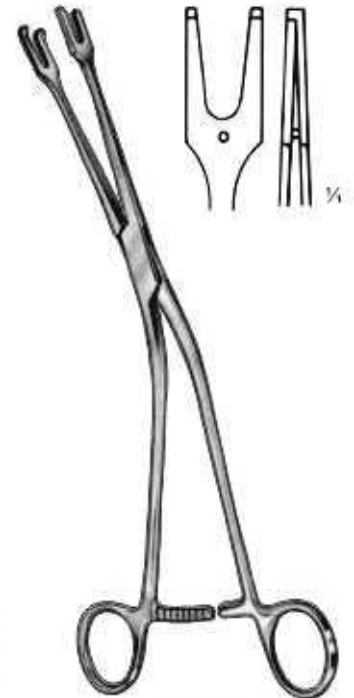

**MILLIN**  
Z-22-171-230  
23 cm, 9"

# BLADDER NECK SPREADER, BLADDER RETRACTORS

Blasenhalsperrer, Blasenwundsperrer

Ecarteur pour le col de la vessie, Ecarteurs vésicaux

Dilatador para el cuello vesical, Separadores vesicales

Divaricatore del collo vescicale, Divaricatore vescicale



**KNUTSON**  
Z-22-172-180  
18 cm, 7"  
Urethrographie-Instruments

22-173-001  
Spare



**MOGEN CIRCUMCISION CLAMP**  
Z-22-174-001

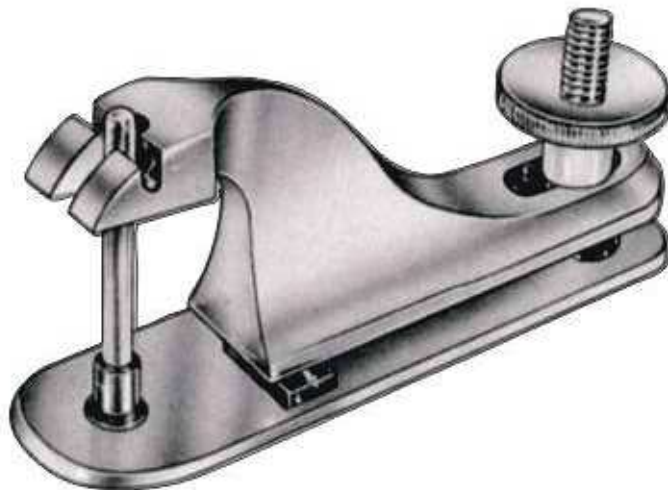

**GUMCO CLAMP**

	mm ø
Z-22-175-008	8
Z-22-176-011	11
Z-22-177-013	13
Z-22-178-016	16
Z-22-179-021	21
Z-22-180-026	26
Z-22-181-032	32

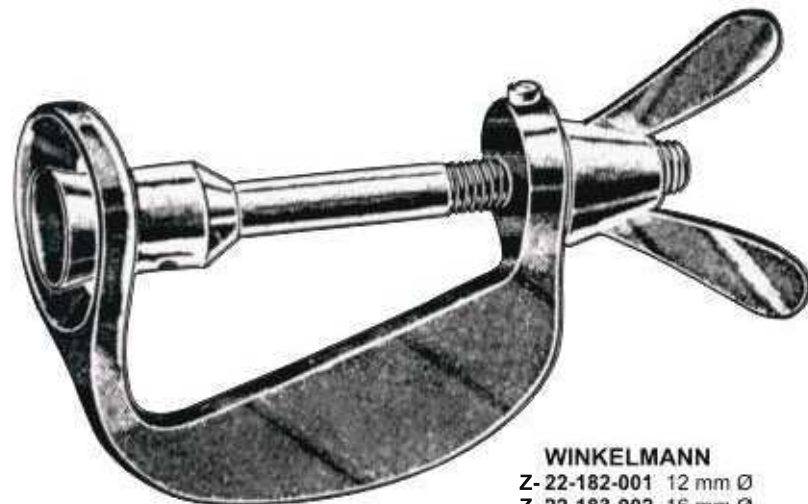

**WINKELMANN**  
Z-22-182-001 12 mm Ø  
Z-22-183-002 16 mm Ø  
Z-22-184-003 20 mm Ø  
Circumcision clamps



**MILLIN**  
Z-22-185-280  
28 cm, 11"

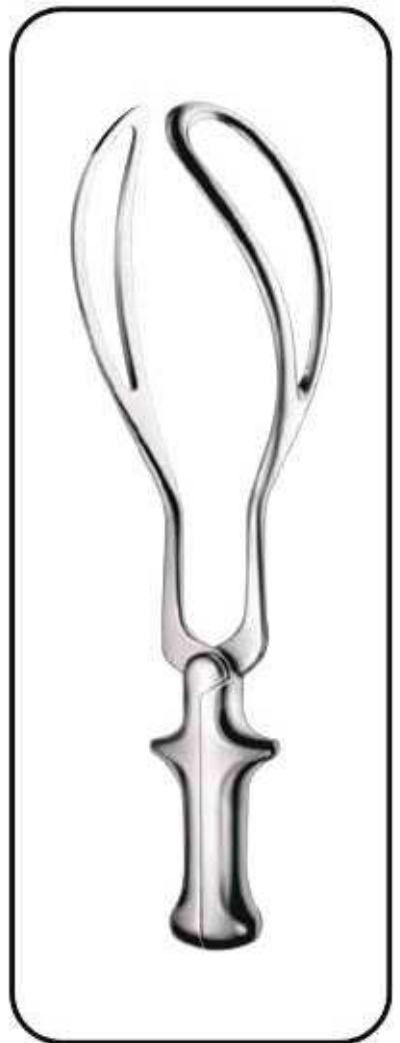



**GRAVES**  
Z-23-001-001  
75 x 20 mm Small  
Z-23-002-002  
95 x 35 mm Medium  
Z-23-003-003  
115 x 35 mm Large



**PEDERSON**  
Z-23-004-001  
75 x 13 mm Small  
Z-23-005-002  
100 x 22 mm Medium  
Z-23-006-003  
120 x 25 mm Large



**Graves Vaginal  
Speculum Leep / Lietz**  
Z-23-007-004 Small  
Z-23-008-005 Medium  
Z-23-009-006 Large  
Z-23-010-007 X-large



**Pederson Vaginal  
Speculum Leep / Lietz**  
Z-23-011-008 Small  
Z-23-012-009 Medium  
Z-23-013-010 Large  
Z-23-014-011 X-Large





**DE VILBISS**  
Z-23-015-001  
4 x 27 mm  
102 mm x 32 mm  
Medium



**SEYFFERT**  
Z-23-016-230 100 x 24 mm  
Z-23-017-230 110 x 32 mm  
23 cm, 9"



**CUSCO**  
Z-23-018-001 75 x 32 mm  
Z-23-019-002 85 x 35 mm  
Z-23-020-003 100 x 35 mm



**CUSCO**  
Z-23-021-004 75 x 17 mm



**CUSCO**  
Z-23-022-001 90 x 22 mm  
Z-23-023-002 100 x 25 mm  
Z-23-024-003 105 x 27 mm

*Vaginalspekula*  
*Espéculos vaginales*



**CUSCO**  
 Z-23-026-001 75 x 32 mm  
 Z-23-027-002 85 x 35 mm  
 Z-23-028-003 100 x 37 mm



**COLLIN**  
 Z-23-029-001 85 x 30 mm  
 Z-23-030-002 100 x 35 mm  
 Z-23-031-003 110 x 40 mm

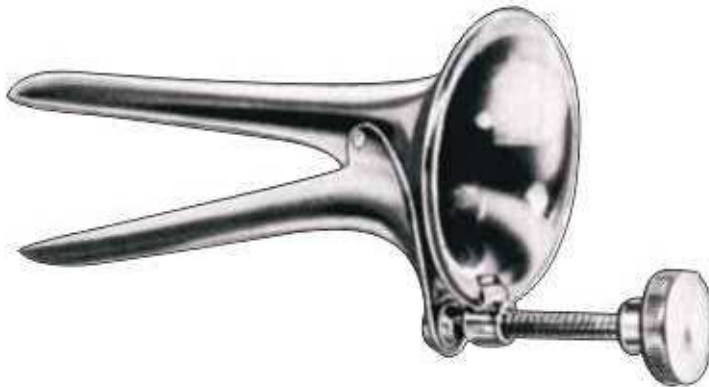

**SEMM**  
 Z-23-032-001 100 x 17 / 20 mm  
 Z-23-033-002 105 x 27 / 30 mm



**COLLIN**  
 Z-23-034-001  
 55 x 10 mm



**TRELAT**  
 Z-23-035-001 85 mm 33 mm  
 Z-23-036-002 95 mm 35 mm  
 Z-23-037-003 115 mm 43 mm



**WINTERTON**  
 Z-23-038-001



**NOTT**  
 Z-23-039-001 90 mm 30 mm  
 Z-23-040-002 100 mm 30 mm



**Z-23-047-175**  
75x10 mm  
17.5 cm

**Z-23-052-175**  
70x15 mm  
175 mm

**Z-23-048-180**  
75x23 mm  
18.0 cm

**Z-23-053-180**  
70x27 mm  
18.0 cm

**Z-23-049-180**  
80x25 mm  
18.0 cm

**Z-23-054-180**  
75x30 mm  
18.0 cm

**Z-23-050-185**  
100x32 mm  
18.5 cm

**Z-23-055-185**  
90x36 mm  
18.5 cm

**KRISTELLER**

- Z-23-041-220 110x18 mm
  - Z-23-042-220 110x20 mm
  - Z-23-043-220 110x27 mm
  - Z-23-044-220 110x30 mm
  - Z-23-045-220 110x36 mm
- 22.0 cm,

**KRISTELLER**

- Z-23-046-001
- Upper Blades

**KRISTELLER**

- Z-23-051-001
- Lower Blades

VAGINAL SPECULA (UPPER AND LOWER BLADES)

Vaginalspekula  
Espéculos vaginales

Spéculums vaginaux  
Specoli vaginali





**Z-23-069-205**  
80 x 28 mm



**Z-23-073-175**  
76 x 38 mm



**Z-23-070-205**  
85 x 35 mm



**Z-23-074-175**  
89 x 38 mm



**Z-23-071-205**  
85 x 40 mm



**Z-23-075-175**  
102 x 38 mm



Slightly Concave

**KRISTELLER**  
Z-23-068-205  
20.5 cm, 8"



Slightly Concave

**JACKSON**  
Z-23-072-175  
17.5 cm, 7"

Vaginalspekula  
 Espéculos vaginales

Spéculum vaginal  
 Specoli vaginali



56 x 13 mm

**BRAUN**  
**Z-23-076-180**  
 18 cm, 7"



60 x 10 mm

**BRAUN**  
**Z-23-077-180**  
 18 cm, 7"



**Z-23-078-280**  
 Handle with cold light  
 carrier for upper blades  
 28 cm, 11"



**SIMON**  
**Z-23-079-275**  
 115 x 22 mm  
 27.5 cm, 10 3/4"



95 x 17-26 mm

**MATHIEU**  
**Z-23-080-210**  
 For children and  
 virgins fitting  
 21 cm, 8 1/2"



95 x 17 - 30 mm

**MATHIEU**  
**Z-23-081-210**  
 For children  
 and virgins  
 21 cm, 8 1/2"

Vaginalspekula, scheidenthalter  
Especulos vaginales, valvas vaginales

Spéculum vaginaux, valves vaginales  
Specoli vaginali, valve vaginali



**BRIESKY**  
Z-23-082-170 72x25 mm / 77x30 mm  
Z-23-083-170 75x30 mm / 92x38 mm  
17 cm, 6 3/4"

**KALLMORGEN VAGINAL SPECULUM**  
Z-23-084-200 70 x 40 mm  
Z-23-085-200 90 x 40 mm  
20 cm, 8"

**KALLMORGEN VAGINAL RETRACTOR**  
Z-23-086-200 70 x 33 mm  
Z-23-087-200 90 x 33 mm  
20 cm, 8"

**MATHIEU Vaginal Retractor**  
Z-23-088-210 95 x 16 mm  
Z-23-089-210 95 x 26 mm  
Z-23-090-210 95 x 30 mm  
21 cm, 8 1/2"

**MATHIEU Vaginal Retractor**  
Z-23-091-220 100 x 11 mm  
Z-23-092-220 100 x 14 mm  
Z-23-093-220 100 x 20 mm  
Z-23-094-220 100 x 26 mm  
22 cm, 8 3/4"



**DOYEN VAGINAL SPECULUM**  
22 cm, 8 3/4"

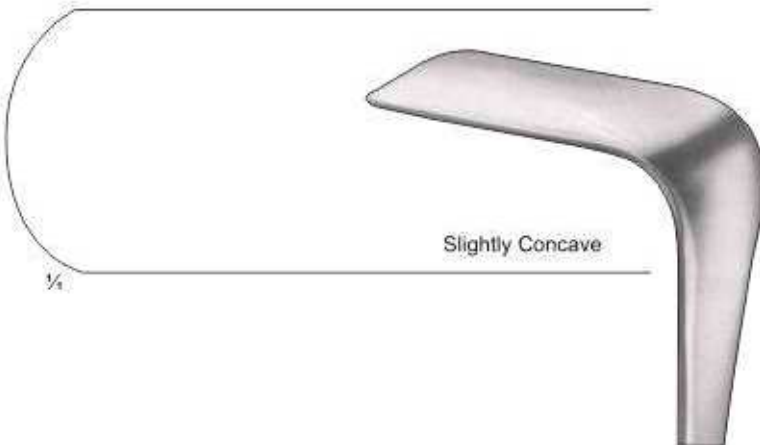

Z-23-095-220 60 x 35 mm  
Z-23-096-220 90 x 35 mm  
Z-23-097-220 120 x 35 mm  
Z-23-098-220 60 x 45 mm  
Z-23-099-220 90 x 45 mm  
Z-23-100-220 120 x 45 mm  
Z-23-101-220 160 x 45 mm  
Z-23-102-220 60 x 60 mm  
Z-23-103-220 90 x 60 mm  
Z-23-104-220 120 x 60 mm  
Z-23-105-220 160 x 60 mm

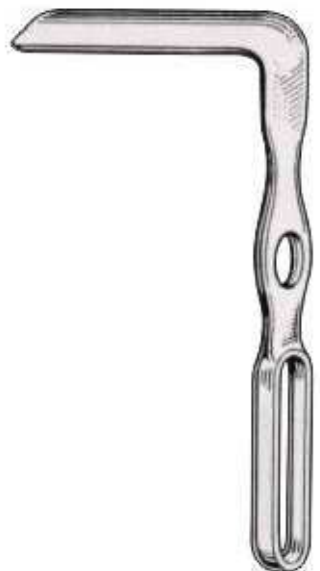

**LANDON VAGINAL RETRACTOR**  
Z-23-106-090  
Blade 9 cm  
Deep 2.5 cm wide.

VAGINAL SPECULA (FOR CHILDREN AND VIRGINS)

Vaginalspekula  
Especulos vaginales

Spéculums vaginaux  
Specoli vaginali



**DOYEN**  
Z-23-107-235  
23.5 cm, 9 1/4"

	Length of blades	Width of blades
Z-23-111-190	60 mm	35 mm
Z-23-112-190	90 mm	45 mm
Z-23-113-190	120 mm	60 mm
Z-23-114-190	160 mm	70 mm
	19 cm, 7 1/2"	



Vaginalspekula, scheidenhalter  
Especulos vaginales, valvas vaginales

Spéculums vaginaux, valves vaginales  
Specoli vaginali, valve vaginali



**BREISKY  
WIENER MODELL/  
VIENNA PATTERN**

- Z-23-115-300 100 x 20 mm
  - Z-23-116-300 100 x 25 mm
  - Z-23-117-300 100 x 30 mm
  - Z-23-118-300 100 x 35 mm
  - Z-23-119-300 100 x 40 mm
- 30 cm, 12"



**BREISKY  
WIENER MODELL/  
VIENNA PATTERN**

- Z-23-120-320 130 x 20 mm
  - Z-23-121-320 130 x 25 mm
  - Z-23-122-320 130 x 30 mm
  - Z-23-123-320 130 x 35 mm
  - Z-23-124-320 130 x 40 mm
- 32 cm, 12 1/2"



**LANDAU**

- Z-23-125-300 105 x 28 mm
  - Z-23-126-300 105 x 38 mm
- 30 cm, 12"



**WEISSBARTH**

- Z-23-127-210 80 x 28 mm
  - Z-23-128-210 85 x 42 mm
- 21 cm, 8 1/4"



**DOYEN**  
Lateral Speculum

- Z-23-129-250 80 x 30 mm
- 25 cm, 10"



**AUVARD**  
**Z-23-130-230**  
65 x 38 mm - 28 mm  
1,530 kg  
with fixed weight  
23 cm, 9"

**AUVARD**  
**Z-23-131-230** 75 x 42 mm  
(40 mm)  
**Z-23-132-230** 105 x 43 mm  
(40 mm)  
with detachable weight  
23 cm, 9"

**MARTIN**  
**Z-23-133-270**  
with hook shaped  
handle for hanging  
in weights  
27 cm, 10 3/4"



**Z-23-134-001**  
80 x 30



**Z-23-135-002**  
85 x 35



**Z-23-136-003**  
85 x 40



**Z-23-137-004**  
55 x 40 - 60 mm



**Z-23-138-005**  
70 x 45 - 70 mm



**Z-23-140-001**  
80 x 30 mm



**Z-23-144-005**  
65 x 30 mm



**Z-23-141-002**  
85 x 33 mm



**Z-23-145-006**  
75 x 35 mm



**Z-23-142-003**  
100 x 38 mm



**Z-23-146-007**  
85 x 35 mm



**Z-23-143-004**  
110 x 42 mm



**Z-23-147-008**  
95 x 35 mm



**SCHERBACK**  
**Z-23-139-006**  
Set consisting of:  
handle  
weight  
5 blades



**SCHERBACK**  
**Z-23-148-009**  
Set consisting of:  
2 handle  
8 blades

Uterussonden, Vaginalspekula  
histerómetros, Espéculos vaginales,

Hystérometres, Spéculums vaginaux,  
isterometri, Specoli vaginali,

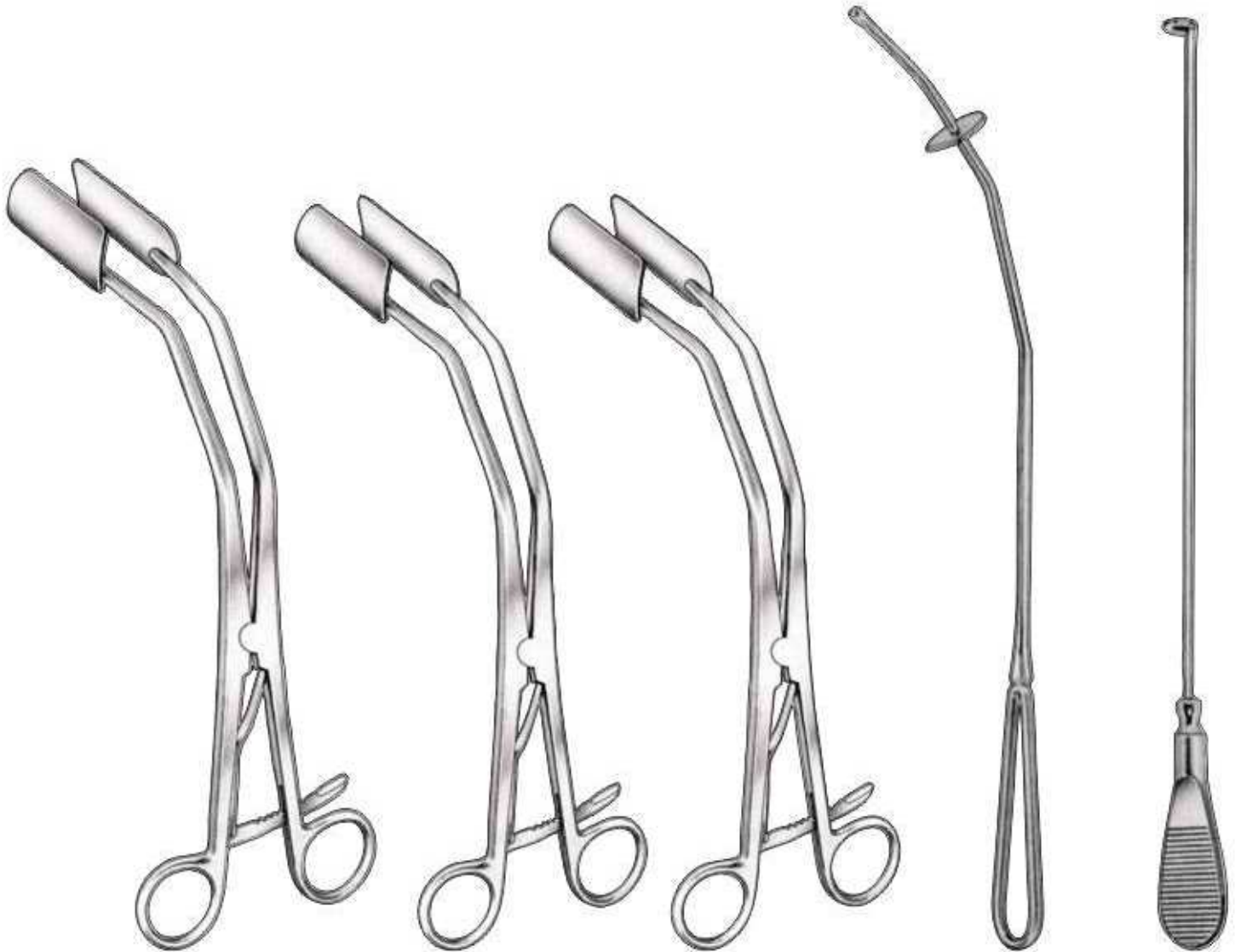

**NEW PORT**  
Z-23-149-250  
25 cm, 10"

**Lateral Vaginal  
Retractor**  
Z-23-150-210  
21 cm 8 1/4"

**Lateral Vaginal Retractor  
Blue Coated Leep / Lietz**  
Z-23-151-210  
21 cm 8 1/4"

**RAMATHIBODI**  
Z-23-152-275  
27.5 cm, 11"  
Uterine Manipulator

**RAMATHIBODI**  
Z-23-153-250  
25 cm, 10"  
Tubal hook

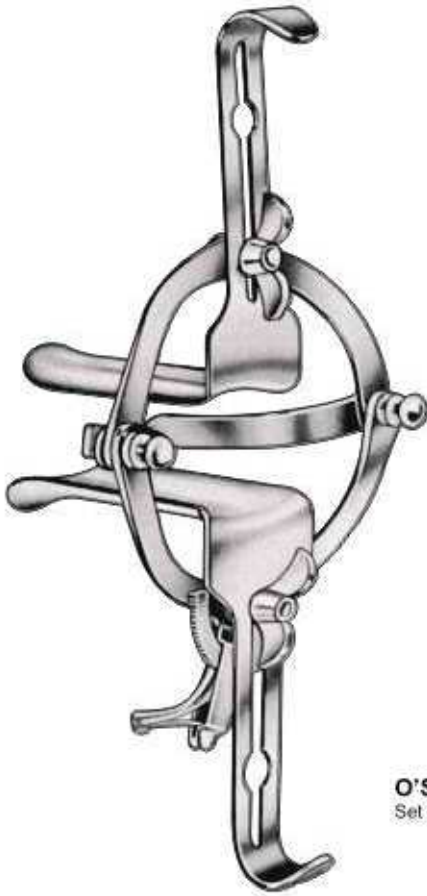

**O'SULLIVAN - O'CONNOR**  
Set of Complete Z-23-154-001  
Z-23-155-002  
Z-23-156-003  
Z-23-157-004



Z-23-155-002  
45 x 17 mm



Z-23-156-003  
90 x 37 mm



Z-23-157-004  
90 x 45 mm



**ABDOMINAL RETRACTOR**  
Z-23-158-090 9 cm, 3 1/2" wide  
Z-23-159-100 10 cm, 4" wide  
Z-23-160-115 11.5 cm, 4 1/2" wide



**FRIEDMANN**  
Z-23-161-100  
10 cm, 4"

Hakenzangen, amniotom  
Pinza para cuello uterino, amniótomo

Pince pour le col de l'utérus, amniotome  
Pinza per il collo dell'utero, amniotomo

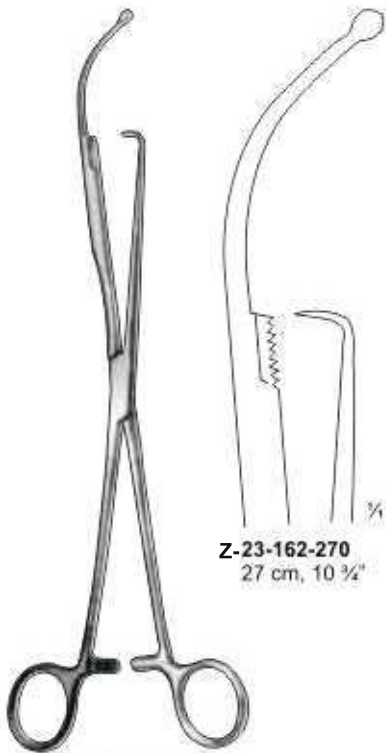

Z-23-162-270  
27 cm, 10 3/4"

HULKA GYNE



Z-23-163-240  
24 cm, 9 1/2"  
With ratchet  
3 mm

KOGAN GYNE



KOGAN  
Z-23-164-240  
24 cm, 9 1/2"



KOGAN  
Z-23-165-240  
24 cm, 9 1/2"

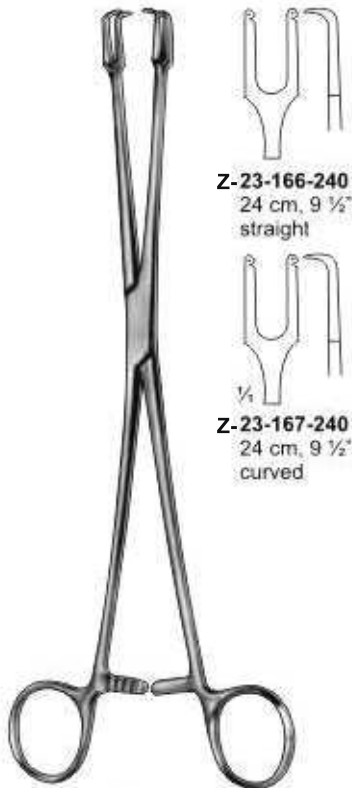

Z-23-166-240  
24 cm, 9 1/2"  
straight

Z-23-167-240  
24 cm, 9 1/2"  
curved

SCHRÖDER GYNE



Z-23-168-250  
25 cm, 10"

SCHRÖDER



Z-23-169-250  
25 cm, 10"

POZZI GYNE

# UTERINE TENACULUM & UTERINE POLYPUS FORCEPS

Hakenzangen, Uterus-Polypen zangen

Pince pour le col de l'utérus, pinces a ploypes utérins

Pinza para cuello uterino, Pinzas para polipos uterinos Pinza per il collo dell'utero, Pinze per polipi uterini



**BARRETT**  
Z-23-170-180  
18 cm, 7"



**SAIRGES**  
Z-23-171-230  
23 cm, 9"

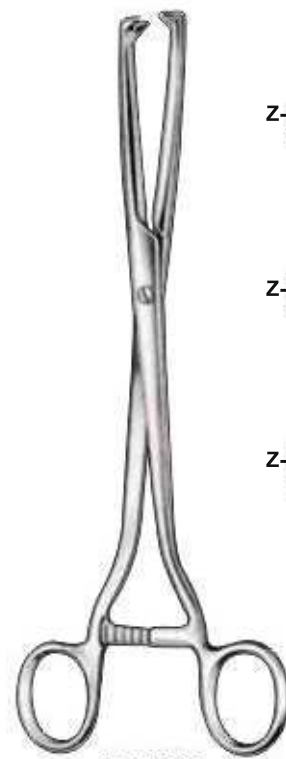

**MUSEUX**  
24 cm, 9 1/2"



Z-23-172-240  
6 mm



Z-23-173-240  
8 mm



Z-23-174-240  
10 mm



**MUSEUX**  
24 cm, 9 1/2"



Z-23-175-240  
6 mm



Z-23-176-240  
8 mm



Z-23-177-240  
10 mm



**PRATT**  
Z-23-178-280  
28 cm, 11"

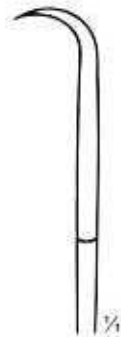
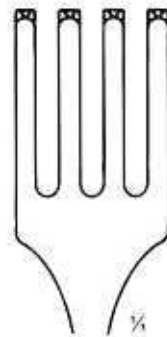

**TEALE**  
Z-23-179-230  
23 cm, 9"



# MYOMA SCREWS, MYOMA KNIFE, UTERINE SEIZING FORCEPS

Myomheber, Myommesser, Uterusfasszange

Tracteurs pour fibromes, evideur de fibromes, Pincés hystérolabes

Tirabuzones para fibroma, cuchillo para fibroma, Histerólabos

Tiramiomi, bisturi per fibromi, Pinze isterolabi



**JACOBS**  
Z-23-180-210  
21 cm, 8 1/4"  
Straight



**IOWA**  
Z-23-181-260  
26 cm, 10 1/4"



**DARTIGUES**  
Z-23-182-270  
27 cm, 10 1/2"

For polypus forceps see Section 6.



**DOYEN**  
Z-23-183-170  
17 cm, 6 3/4"



**DOYEN**  
Z-23-184-140  
14 cm, 5 1/2"

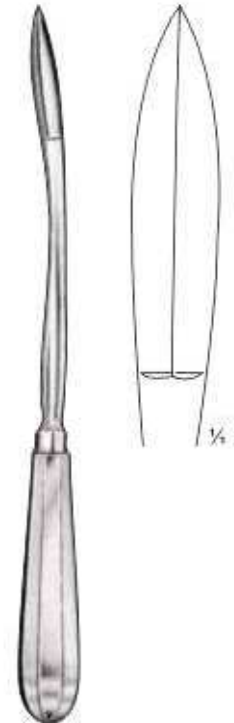

**SEGOND**  
Z-23-185-270  
27 cm, 10 1/2"



# UTERINE SCOOPS, SUCTION CURETTES & UTERINE DEPRESSOR

Uteruslöffel, Absaugküretten, uterusdepressor  
Cucharillas uterinas, Curetas aspiradoras, depresor uterino

Curettes uterines, curettes d'aspiration, Dépresseur utérin  
Curette uterine, curette pe aspirazione, depressore uterino



**BRAUN**  
Z-23-186-280  
28 cm, 11"

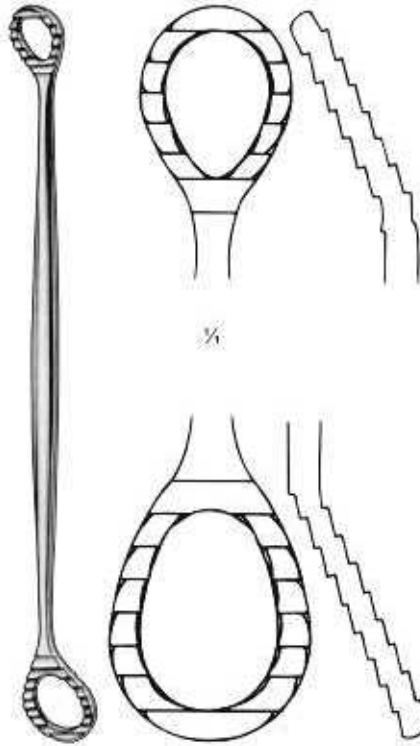

**SIMS**  
Z-23-187-260  
26 cm, 10 1/4"



**KEVORKIAN**



**Z-23-188-300**  
30 cm, 12"  
1.2mm



**Z-23-189-300**  
30 cm, 12"  
4.0 mm  
Without Basket



**Z-23-190-300**  
30 cm, 12"  
4.0 mm  
With Basket



**BLAKE**  
Z-23-191-270  
27 cm, 10 3/4"



Sharp 1/4"



Blunt 1/4"



**SCHROEDER**  
30 cm, 12"  
sharp, rigid



Z-23-192-001



Z-23-193-002



Z-23-194-003



Z-23-195-004



Z-23-196-005



Z-23-197-006

# UTERINE SCOOPS, SUCTION CURETTES & UTERINE DEPRESSOR



Uteruslöffel, Absaugkürretten, uterusdepressor

Curettes uterines, curettes d'aspiration, Dépresseur utérin

Cucharillas uterinas, Curetas aspiradoras, depresor uterino

Curette uterine, curette pe aspirazione, depressore uterino



**SIMON/  
SCHRODER**



Fig. 1  
Z-23-198-250 25 cm, 10"  
Z-23-199-300 30 cm, 12"

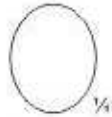

Fig. 3  
Z-23-202-250 25 cm, 10"  
Z-23-203-300 30 cm, 12"

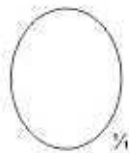

Fig. 5  
Z-23-206-250 25 cm, 10"  
Z-23-207-300 30 cm, 12"



Fig. 2  
Z-23-200-250 25 cm, 10"  
Z-23-201-300 30 cm, 12"

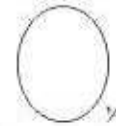

Fig. 4  
Z-23-204-250 25 cm, 10"  
Z-23-205-300 30 cm, 12"

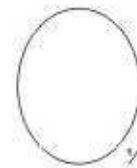

Fig. 6  
Z-23-208-250 25 cm, 10"  
Z-23-209-300 30 cm, 12"



**COLLIN**  
28 cm, 11"



Z-23-210-280  
8.0 mm



Z-23-211-280  
10.0 mm



Z-23-212-280  
12.0 mm

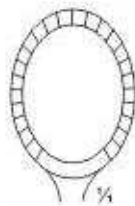

Z-23-213-280  
14.0 mm



**GOURDET**  
28 cm, 11"



Fig. 1  
Z-23-214-280



Fig. 2  
Z-23-215-280



Fig. 3  
Z-23-216-280



Fig. 4  
Z-23-217-280



Fig. 5  
Z-23-218-280



**RECAMIER  
UTERINE CURETTE**  
Z-23-219-260 26 cm 10 1/4"  
Z-23-220-310 31cm, 12 1/4"  
Sharp/Blunt

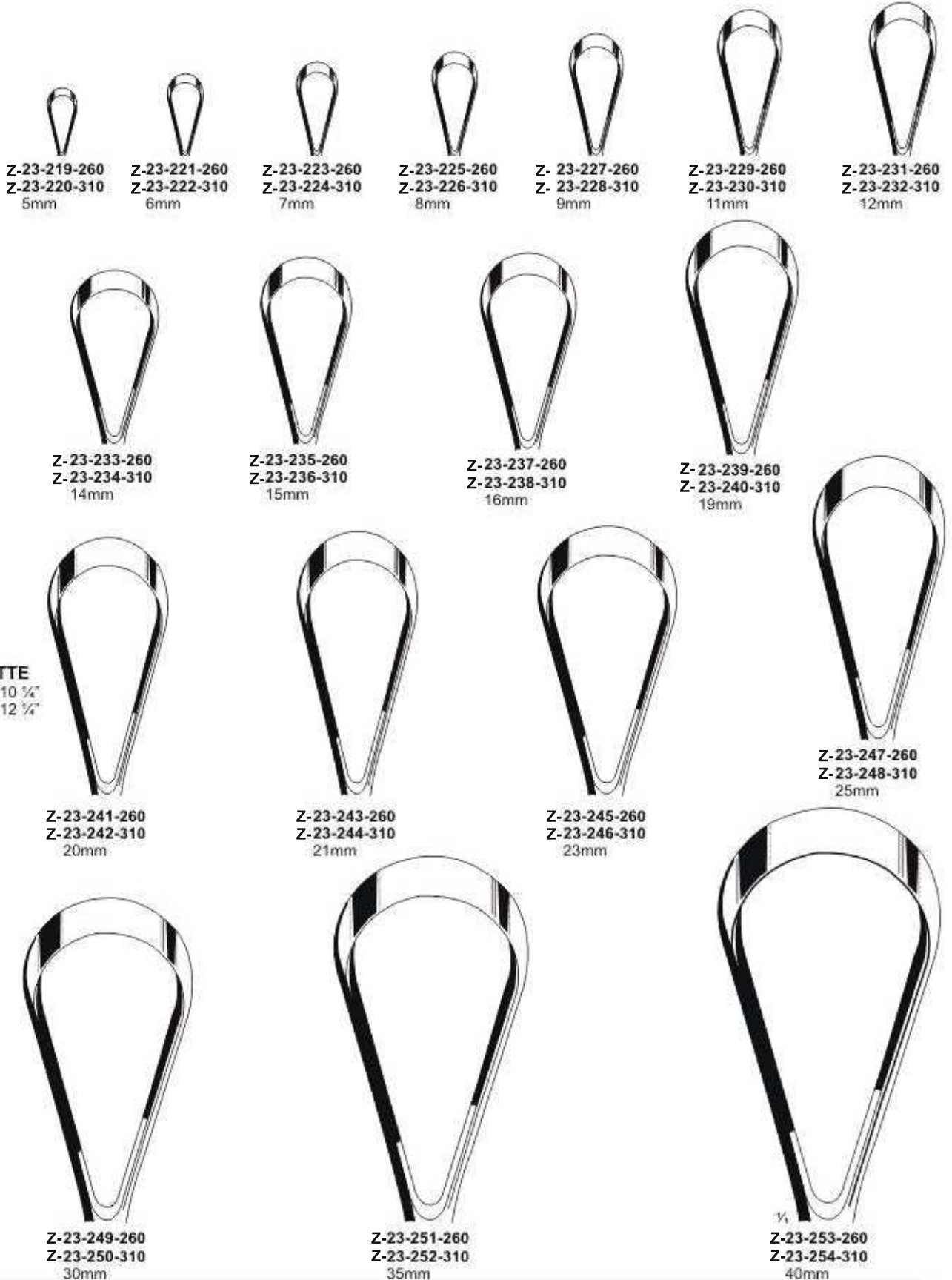

Uterusküretten  
 Curetas uterinas

Curettes utérines  
 curette uterine



Recamier  
 Uterine Curette  
**Z-23-255-260**  
 26 cm, 10 1/4"  
**Z-23-256-310**  
 31cm, 12 1/2"  
 Sharp/Blunt

	 <b>Z-23-255-260</b> <b>Z-23-256-310</b> 5mm	 <b>Z-23-257-260</b> <b>Z-23-258-310</b> 6mm	 <b>Z-23-259-260</b> <b>Z-23-260-310</b> 7mm	 <b>Z-23-261-260</b> <b>Z-23-262-310</b> 8mm	 <b>Z-23-263-260</b> <b>Z-23-264-310</b> 9mm	 <b>Z-23-265-260</b> <b>Z-23-266-310</b> 11mm	 <b>Z-23-267-260</b> <b>Z-23-268-310</b> 12mm
	 <b>Z-23-269-260</b> <b>Z-23-270-310</b> 14mm	 <b>Z-23-271-260</b> <b>Z-23-272-310</b> 15mm	 <b>Z-23-273-260</b> <b>Z-23-274-310</b> 16mm	 <b>Z-23-275-260</b> <b>Z-23-276-310</b> 19mm			
	 <b>Z-23-277-260</b> <b>Z-23-278-310</b> 20mm	 <b>Z-23-279-260</b> <b>Z-23-280-310</b> 21mm	 <b>Z-23-281-260</b> <b>Z-23-282-310</b> 23mm	 <b>Z-23-283-260</b> <b>Z-23-284-310</b> 25mm			
	 <b>Z-23-285-260</b> <b>Z-23-286-310</b> 30mm	 <b>Z-23-287-260</b> <b>Z-23-288-310</b> 35mm	 <b>Z-23-289-260</b> <b>Z-23-290-310</b> 40mm				



Sims  
Uterine Curette  
Z-23-291-260  
26 cm, 10 1/4"  
Z-23-292-310  
31cm, 12 1/2"  
Sharp/Blunt

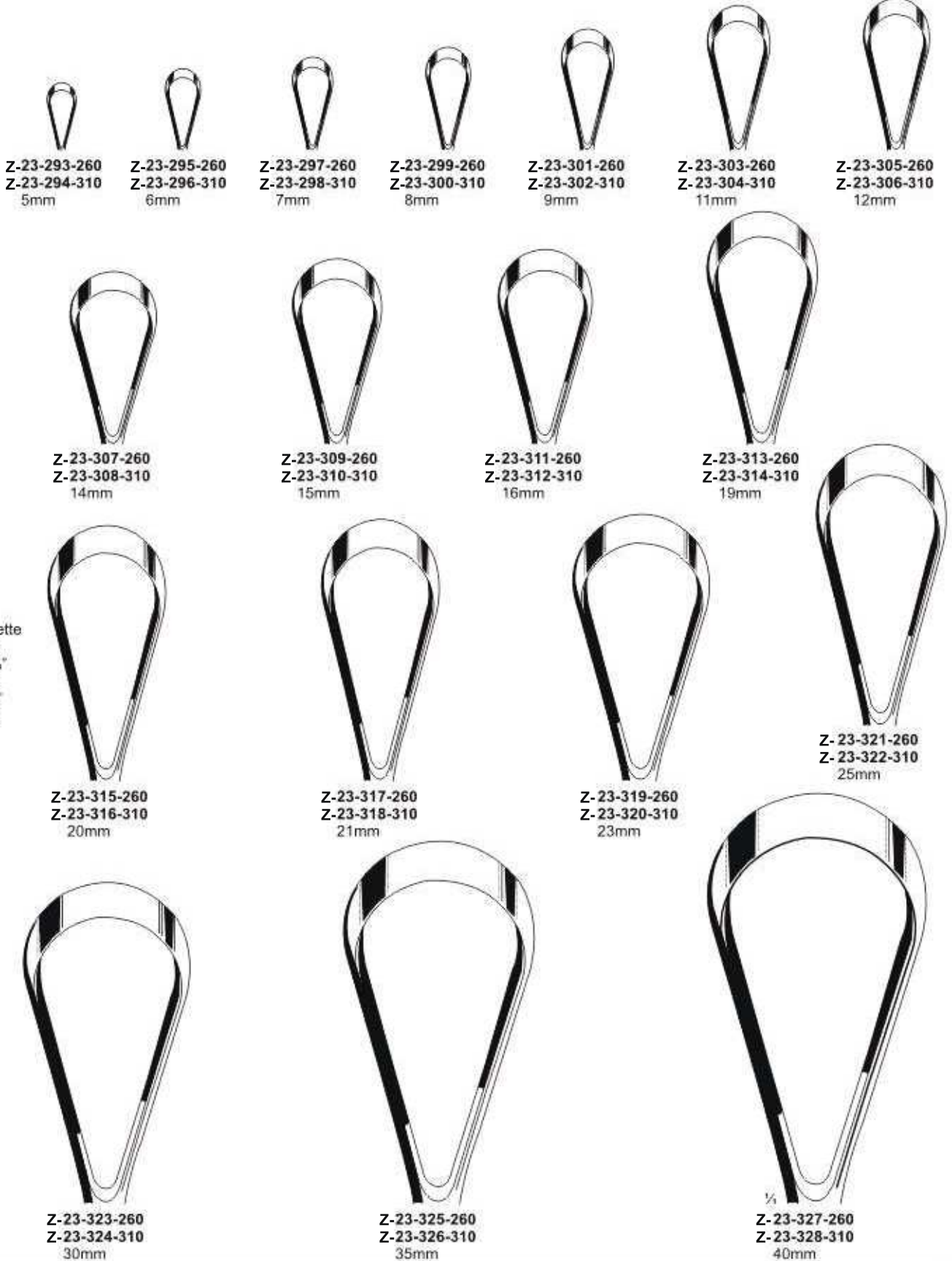

Uterusküretten  
 Curetas uterinas

Curettes utérines  
 curette uterine



Sims  
 Uterine Curette  
**Z-23-329-260**  
 26 cm, 10 1/4"  
**Z-23-330-310**  
 31cm, 12 1/2"  
 Sharp/Blunt

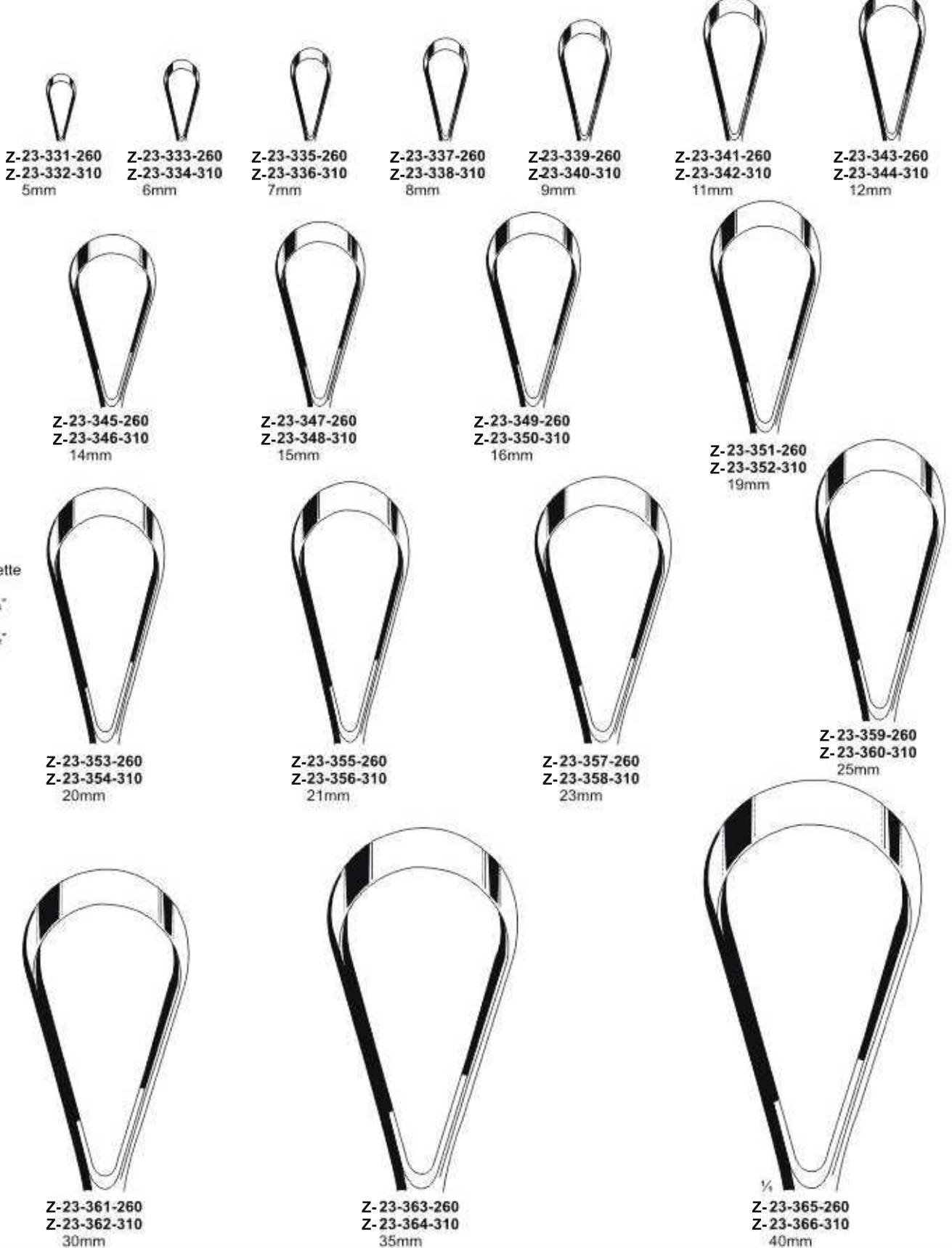

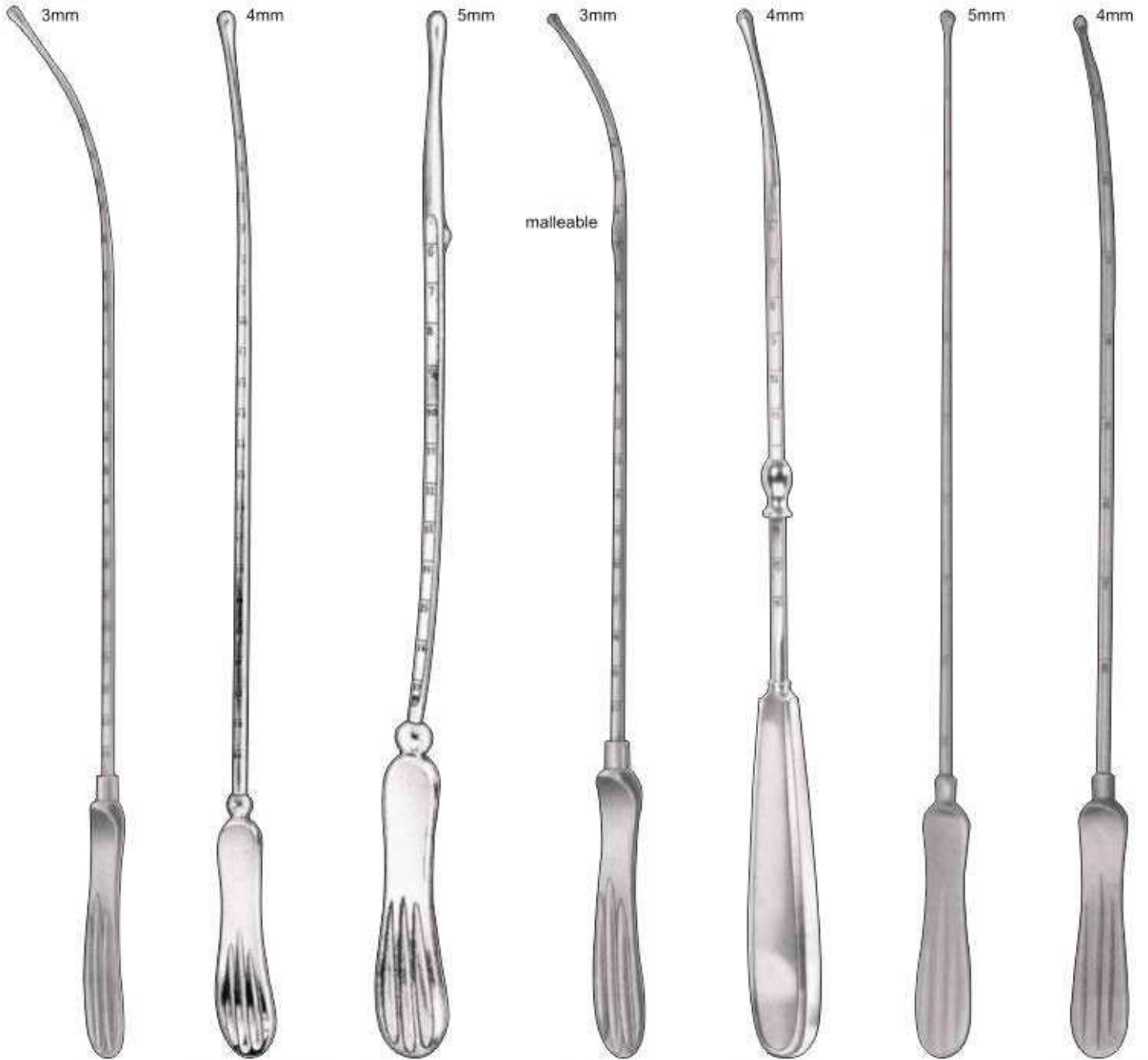

**SIMS**  
Z-23-367-320  
32 cm, 13"  
right  
malleable

**SIMS-SPECIAL**  
Z-23-368-320  
32 cm, 13"

**SIMS**  
schwed. Modell  
Z-23-369-260  
26 cm, 10 1/4"

**MARTIN**  
Z-23-370-300  
30 cm, 12"

**VALLEIX**  
Z-23-371-250  
25 cm, 10"

**MAYO**  
Z-23-372-330  
biegsam  
malleable  
33 cm

**SIMPSON**  
Z-23-373-290  
malleable  
silver-plated  
29 cm

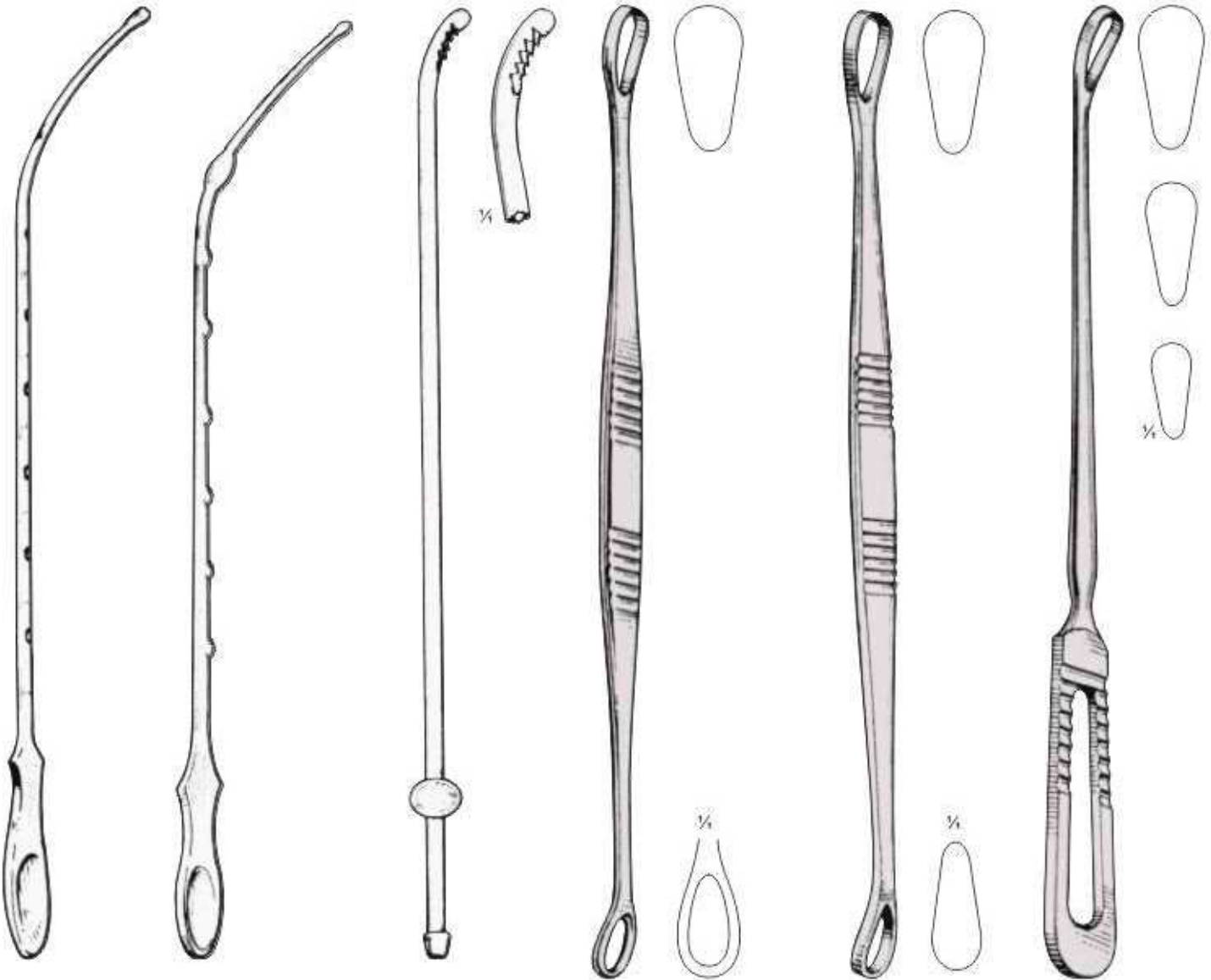

**GALABIN**  
Z-23-374-320  
malleable, shaft  
graduated in cm  
Silver plated,  
32 cm, 12 1/4"

**HORROCKS  
UTERINE  
SOUND**  
Z-23-375-320  
malleable, shaft  
graduated in cm  
Silver plated,  
32 cm, 12 1/4"

**NOVAK "SUCTION  
CANNULA  
CURETTE"**  
Z-23-376-254  
Luer cone,  
25.4 cm, 10"

**SIMS UTERINE  
CURETTE**  
Z-23-377-250  
double ended, sharp  
as above but blunt  
25 cm, 10"  
small, medium, large

**SIMS UTERINE  
CURETTE.**  
Z-23-378-250  
double ended, sharp  
25 cm, 10"  
long.

**SIMS UTERINE  
CURETTE**  
Z-23-379-250  
single ended, sharp  
and blunt ends.  
25 cm, 10"  
long.



**Z-23-380-250**

suction currettes, stainless steel, fitting hose connection.

Working tips are smoothly rounded of, therefore no danger of perforation.



(Suitable for suction biopsy)

- Z-23-380-250:** diam 4 mm
- Z-23-381-250:** diam 6 mm
- Z-23-382-250:** diam 8 mm
- Z-23-383-250:** diam 10 mm
- Z-23-384-250:** diam 12 mm
- Z-23-385-250:** diam 14 mm

**Z-23-386-250**

Hose connection inside diam. 11 mm curved stainless steel.



**Z-23-387-250**

The new connection between suction currette and hose connection, Guarantees quick changing and free turning of the suction currettes on the hoseconnection

**Z-23-388-250**

Transparent suction hose 1.8 mm long, inside diam 11 mm, outside diam 16.5 mm can be sterilized in an autoclave at 1 bar overpressure (120 C)

**Z-23-389-250**

Strainer for tissure, plastic for single use only, to be used for histopathological examination.





**BOZEMANN-FRITSCH**  
Z-23-390-350 diam 8 mm  
Z-23-391-350 diam 10 mm  
Uterine Flushing Tube  
35 cm, 13 3/4"



**SCHULZE**  
Z-23-392-350  
Salpingograph, for utero-salpingography  
in wooden case, consisting of:  
Manometer, Connection, Uterine canulla  
with tap, cone S.M.L,  
record syringe 10 cc, Luer lock mount.



**SCHULZE**  
Z-23-393-350  
Salpingograph, equipment  
without manometer.



PRATT GYNE



**PRATT GYNE**  
**Z-23-394-001**  
Set of 8 Double ended  
size 13/14 thru 41/43  
4.5/5.0mm thru 13.6/14.3mm

- Z-23-395-001 04.5/05.0 mm
- Z-23-396-002 05.6/06.3 mm
- Z-23-397-003 07.0/07.6 mm
- Z-23-398-004 08.3/09.0 mm
- Z-23-399-005 09.6/10.3 mm
- Z-23-400-006 11.0/11.6 mm
- Z-23-401-007 12.3/13.0 mm
- Z-23-402-008 13.6/14.3 mm



**HEGAR**  
**Z-23-403-001**  
Set of 8 dilator  
3/4 mm - 17/18 mm  
**Z-23-404-002**  
Set of 13 dilator  
1/2 mm - 25/26 mm



HANK

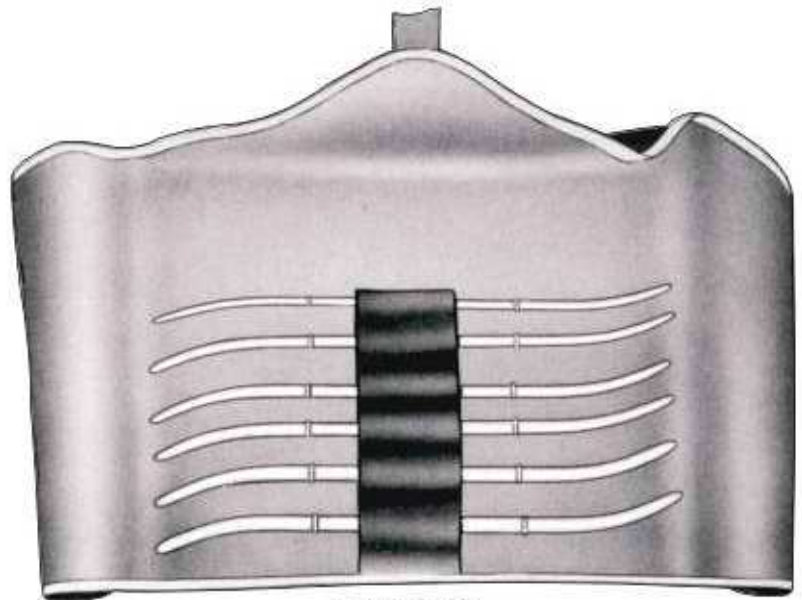

**HANK GYNE**  
**Z-23-411-001**  
Set of 6 dilators  
4.5/5.0 mm - 9.5/10.0 mm

- Z-23-405-001 4.5/5 mm
- Z-23-406-002 5.5/6 mm
- Z-23-407-003 6.5/7 mm
- Z-23-408-004 7.5/8 mm
- Z-23-409-005 8.5/9 mm
- Z-23-410-006 9.5/10 mm

Uterusdilatoren  
Dilatadores uterinos

UTERINE DILATORS **ZIANA**  
Dilatateurs du col de l'utérus  
Dilatatori uterini **INDUSTRIES**



**Z-23-412-001**  
Set of 13 dilators  
1/2 mm - 25/26 mm  
**Z-23-413-002**  
Set of 8 dilators  
3/4 mm - 17/18 mm

#### HEGAR GYNE



**Z-23-427-001** 1 mm  
**Z-23-428-002** 2 mm  
**Z-23-429-003** 3 mm  
**Z-23-430-004** 4 mm  
**Z-23-431-005** 5 mm  
**Z-23-432-006** 6 mm  
**Z-23-433-007** 7 mm  
**Z-23-434-008** 8 mm  
**Z-23-435-009** 9 mm  
**Z-23-436-010** 10 mm  
**Z-23-437-011** 11 mm  
**Z-23-438-012** 12 mm  
**Z-23-439-013** 13 mm  
**Z-23-440-014** 14 mm  
**Z-23-441-015** 15 mm  
**Z-23-442-016** 16 mm  
**Z-23-443-017** 17 mm  
**Z-23-444-018** 18 mm  
**Z-23-445-019** 19 mm  
**Z-23-446-020** 20 mm  
**Z-23-447-021** 21 mm  
**Z-23-448-022** 22 mm  
**Z-23-449-023** 23 mm  
**Z-23-450-024** 24 mm  
**Z-23-451-025** 25 mm  
**Z-23-452-026** 26 mm  
**Z-23-453-027** 27 mm  
**Z-23-454-028** 28 mm  
**Z-23-455-029** 29 mm  
**Z-23-456-030** 30 mm

**HEGAR GYNE** **Z-23-426-001**  
Set of 26 dilators  
1 mm - 26 mm

**Z-23-412-001** 01/02 mm  
**Z-23-413-002** 03/04 mm  
**Z-23-414-003** 05/06 mm  
**Z-23-415-004** 07/08 mm  
**Z-23-416-005** 09/10 mm  
**Z-23-417-006** 11/12 mm  
**Z-23-418-007** 13/14 mm  
**Z-23-419-008** 15/16 mm  
**Z-23-420-009** 17/18 mm  
**Z-23-421-010** 19/20 mm  
**Z-23-422-011** 21/22 mm  
**Z-23-423-012** 23/24 mm  
**Z-23-424-013** 25/26 mm



**HEGAR GYNE**  
**Z-23-425-001**  
Set of 8 dilators  
3/4 mm - 17/18 mm

**Z-23-457-001**  
Set of 14 dilators  
4 mm - 17 mm

**Z-23-458-001** 1.5 mm  
**Z-23-459-002** 2.5 mm  
**Z-23-460-003** 3.5 mm  
**Z-23-461-004** 4.5 mm  
**Z-23-462-005** 5.5 mm  
**Z-23-463-006** 6.5 mm  
**Z-23-464-007** 7.5 mm  
**Z-23-465-008** 8.5 mm  
**Z-23-466-009** 9.5 mm  
**Z-23-467-010** 10.5 mm  
**Z-23-468-011** 11.5 mm  
**Z-23-469-012** 12.5 mm  
**Z-23-470-013** 13.5 mm  
**Z-23-471-014** 14.5 mm  
**Z-23-472-015** 15.5 mm  
**Z-23-473-016** 16.5 mm  
**Z-23-474-017** 17.5 mm  
**Z-23-475-018** 18.5 mm  
**Z-23-476-019** 19.5 mm



**HEGAR GYNE**  
**Z-23-477-001**  
Set of 14 dilators  
4 mm - 17 mm

# UTERINE BIOPSY FORCEPS

Probeexzisionszangen  
Pinzas para biopsia

Pinces pour biopsi  
Pinze per biopsia

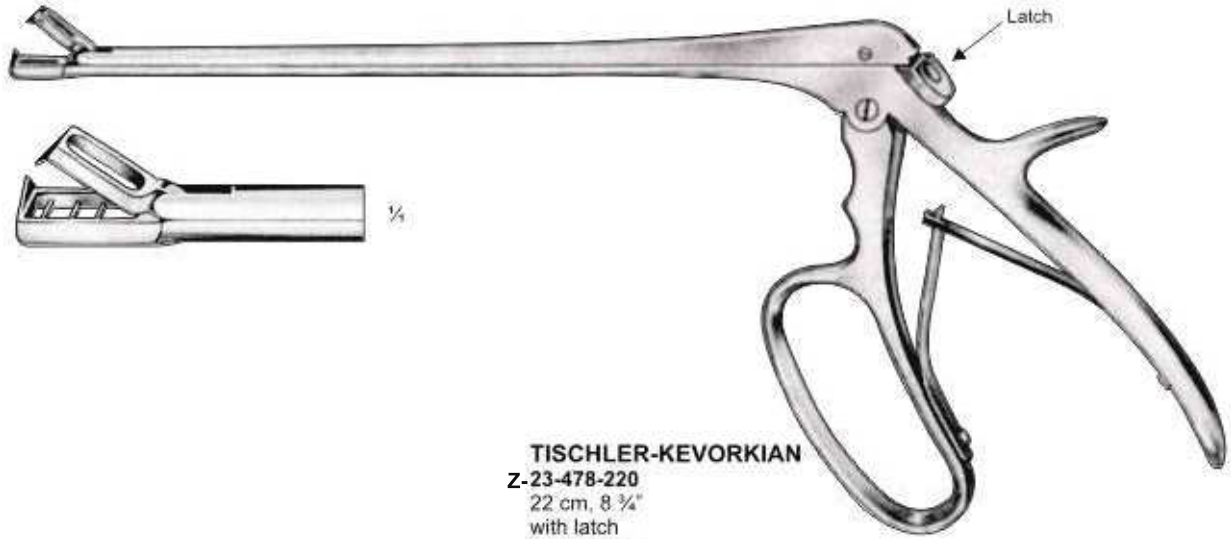

**TISCHLER-KEVORKIAN**  
Z-23-478-220  
22 cm, 8 3/4"  
with latch  
3 x 9.5 mm

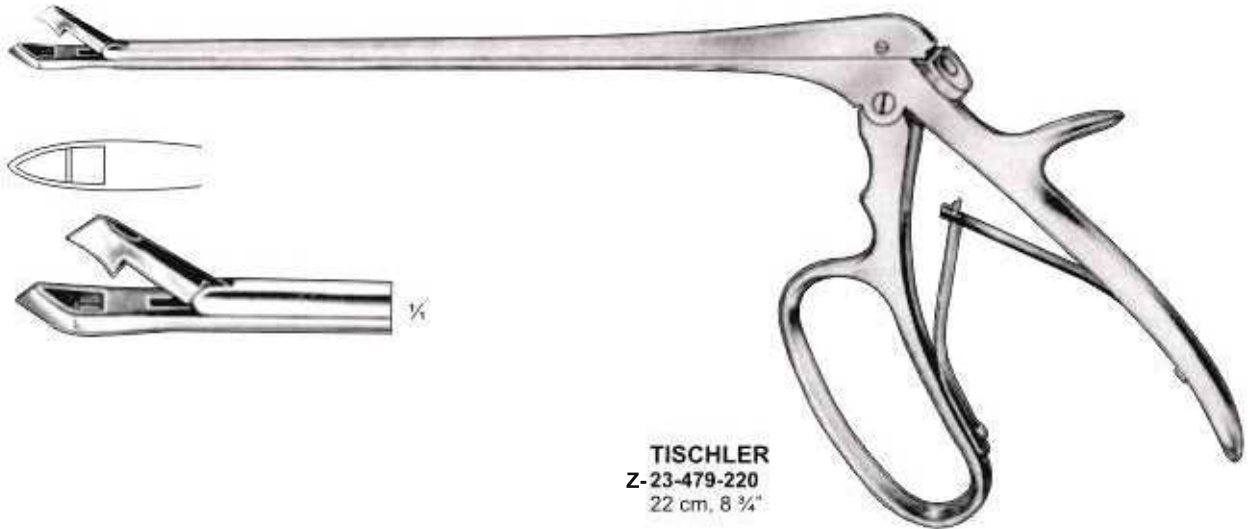

**TISCHLER**  
Z-23-479-220  
22 cm, 8 3/4"

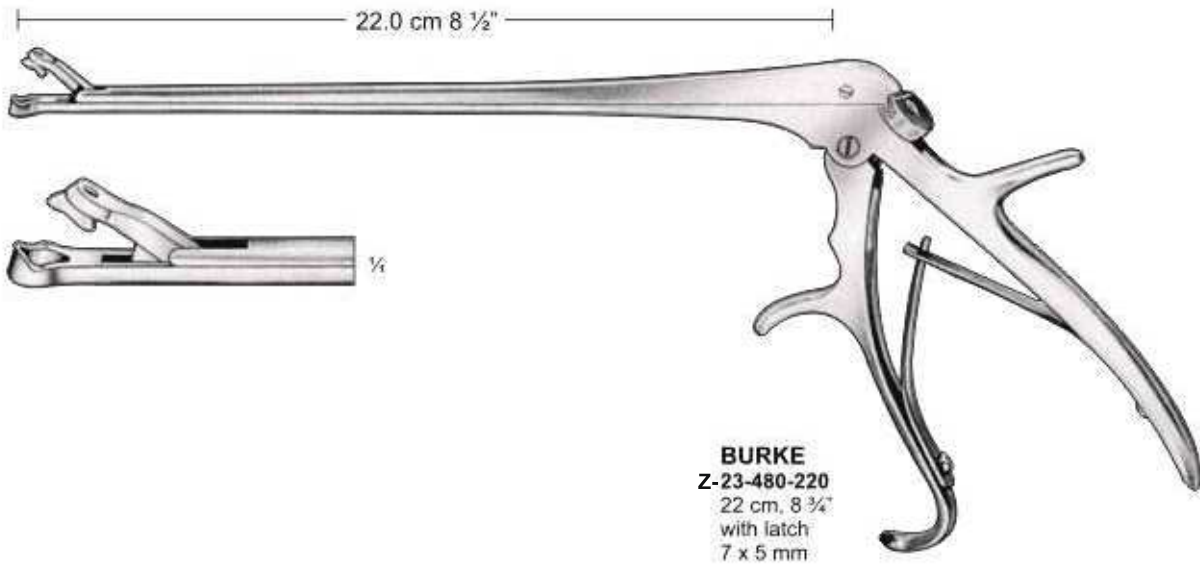

**BURKE**  
Z-23-480-220  
22 cm, 8 3/4"  
with latch  
7 x 5 mm

Probeexzisionszangen  
 Pinzas para biopsia

Pincas pour biopsi  
 Pinze per biopsia

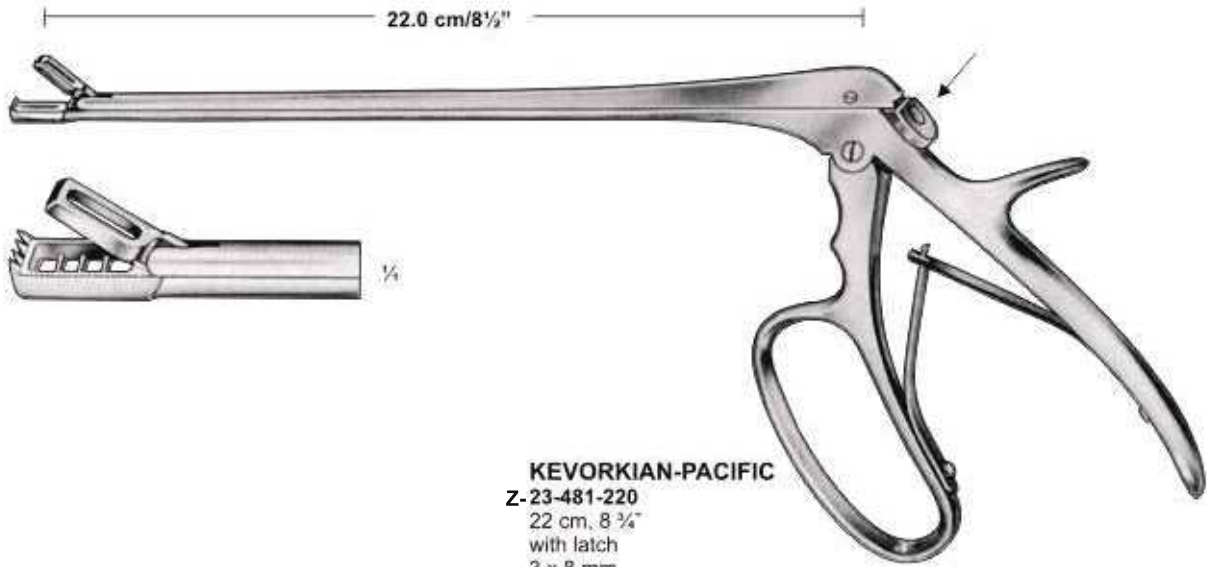

**KEVORKIAN-PACIFIC**  
 Z-23-481-220  
 22 cm, 8 1/2"  
 with latch  
 3 x 8 mm

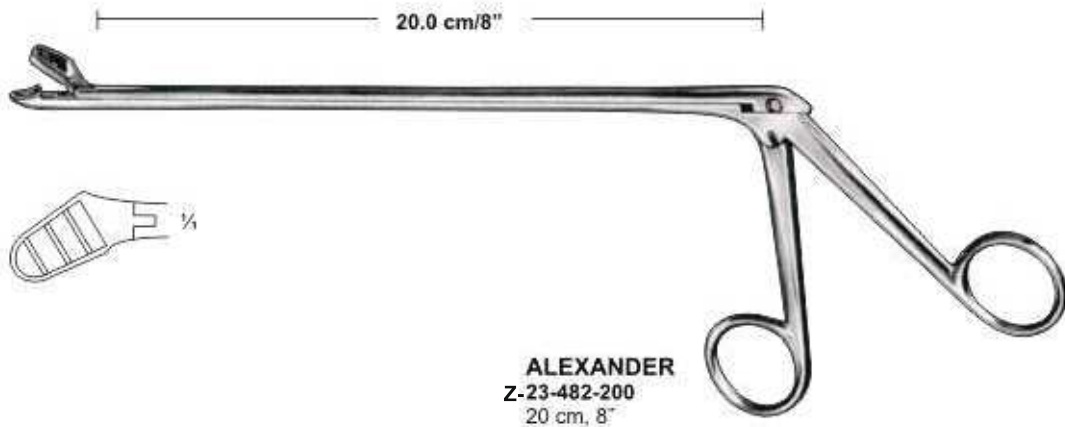

**ALEXANDER**  
 Z-23-482-200  
 20 cm, 8"

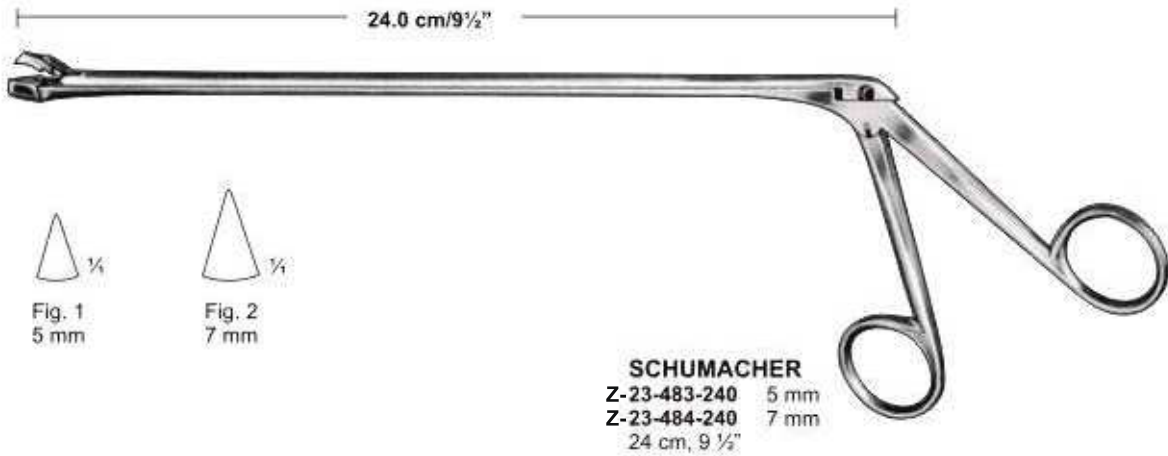

**SCHUMACHER**  
 Z-23-483-240 5 mm  
 Z-23-484-240 7 mm  
 24 cm, 9 1/2"

# UTERINE BIOPSY FORCEPS

Probeexzisionszangen  
Pinzas para biopsia

Pinces pour biopsi  
Pinze per biopsia

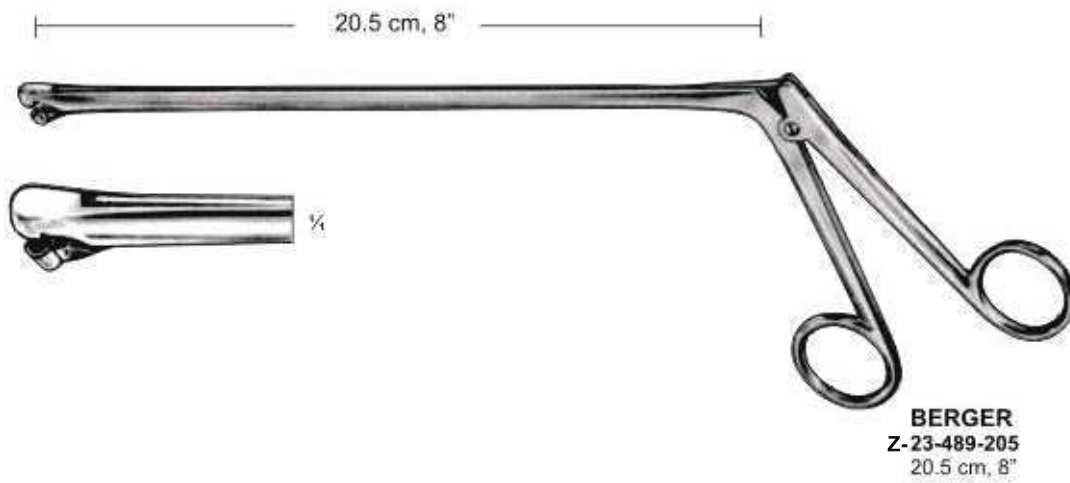
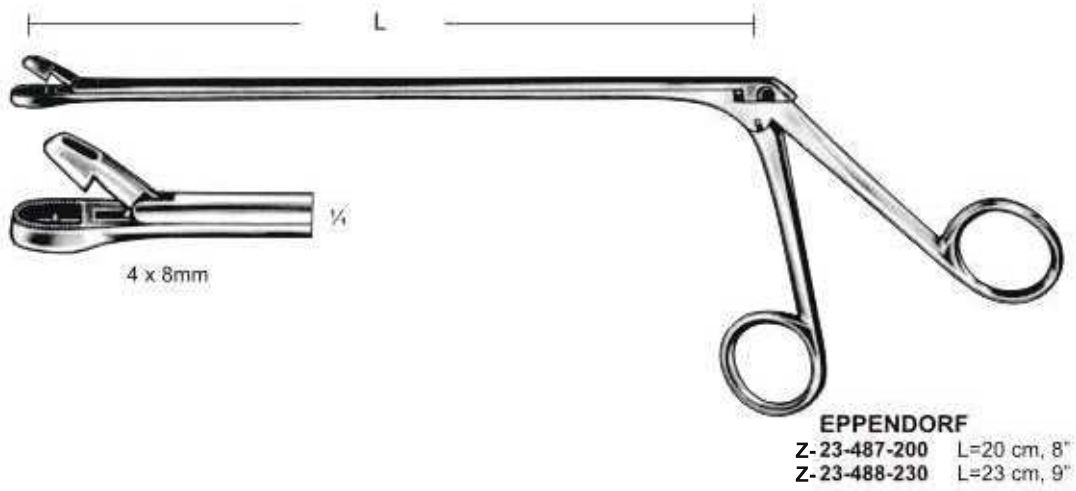
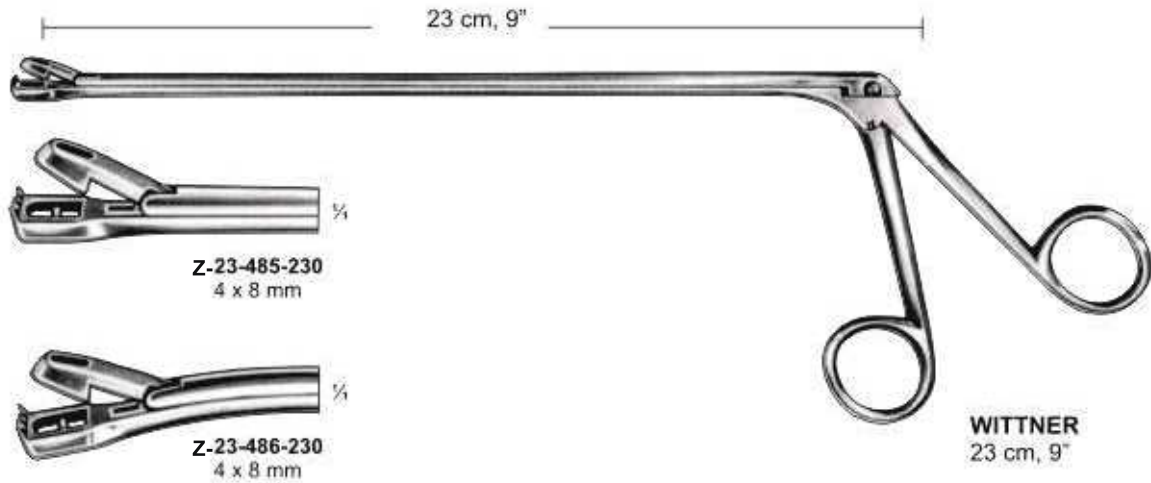

Probeexzisionszangen  
 Pinzas para biopsia

Pinces pour biopsi  
 Pinze per biopsia

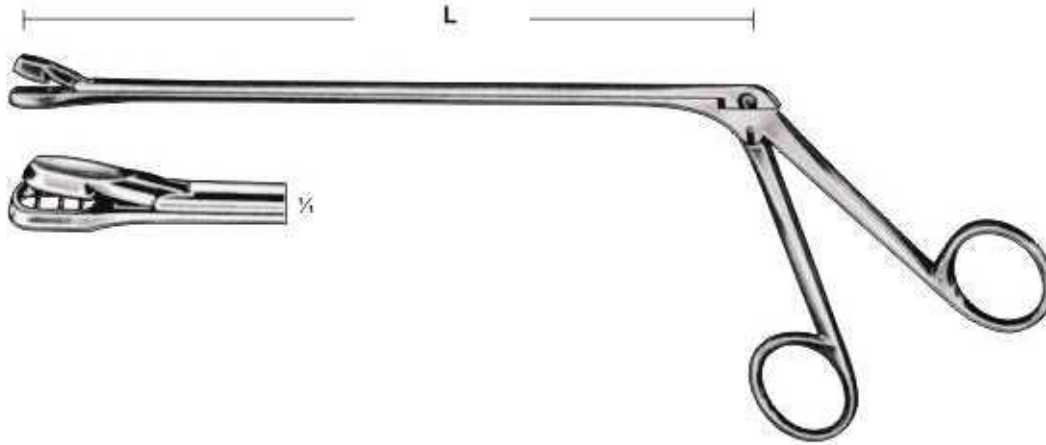

**DOUAY**

- Z-23-490-200 L=20 cm, 8"
- Z-23-491-250 L=25 cm, 10"
- Z-23-492-300 L=30 cm, 12"
- Z-23-493-350 L=35 cm, 14"
- Z-23-494-400 L=40 cm, 16"

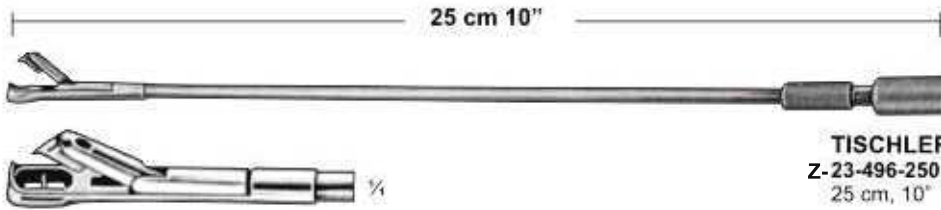

**TISCHLER**  
 Z-23-496-250  
 25 cm, 10"



**KEVORKIAN**  
 Z-23-497-250  
 25 cm, 10"

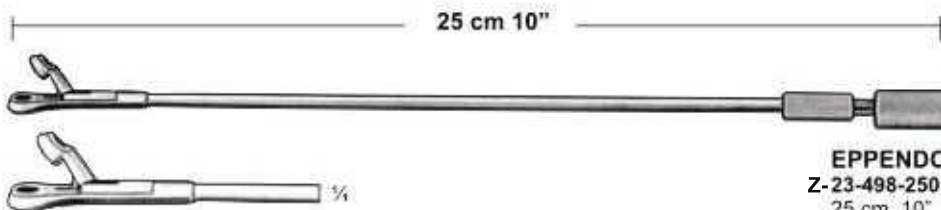

**EPPENDORF**  
 Z-23-498-250  
 25 cm, 10"

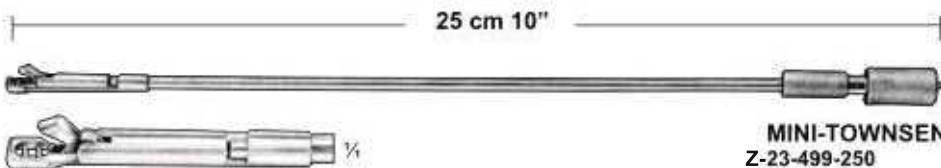

**MINI-TOWNSEND**  
 Z-23-499-250  
 25 cm, 10"



Z-23-495-001



# UTERINE BIOPSY FORCEPS

Probeexzisionszangen  
Pinzas para biopsia

Pinces pour biopsi  
Pinze per biopsia

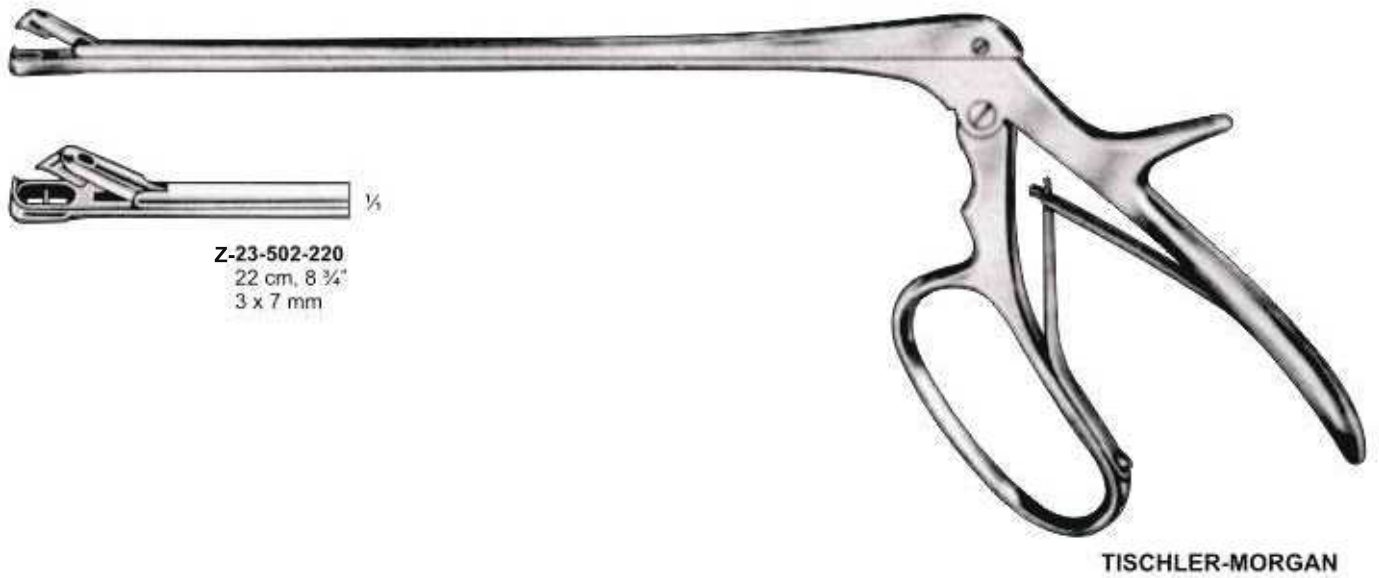
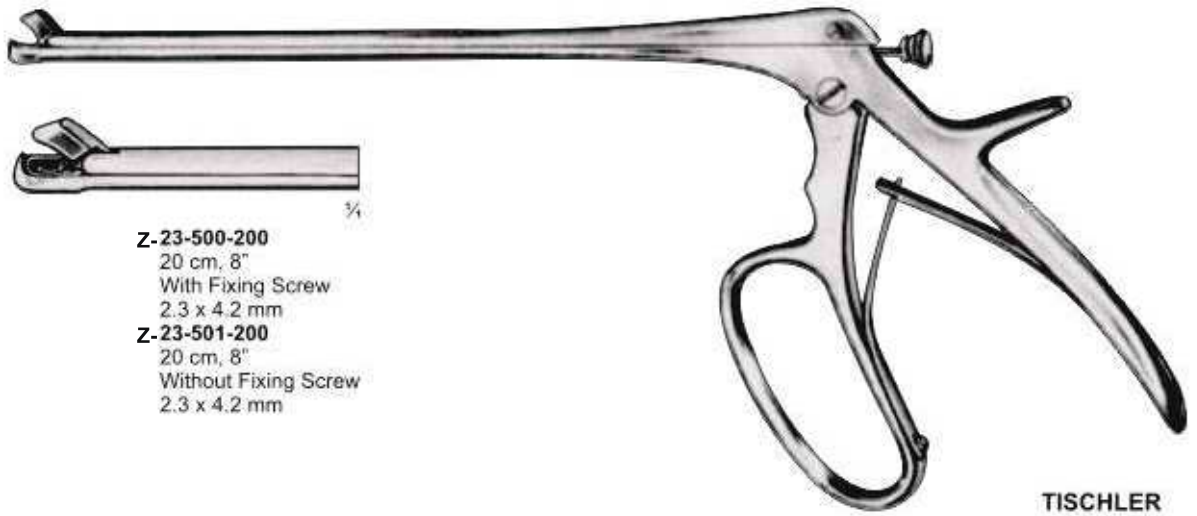

Probeexzisionszangen  
 Pinzas para biopsia

 Pincés pour biopsi  
 Pinze per biopsia

**GELLHORN**  
 Z-23-505-230  
 23 cm, 9"

**FAURE**  
 Z-23-506-230  
 23 cm, 9"

**SCHUBERT**  
 Z-23-507-210 21 cm, 8 1/4"  
 Z-23-508-280 28 cm, 11"

**THOMS-GAYLOR**  
 Z-23-509-240  
 24 cm, 9 1/2"

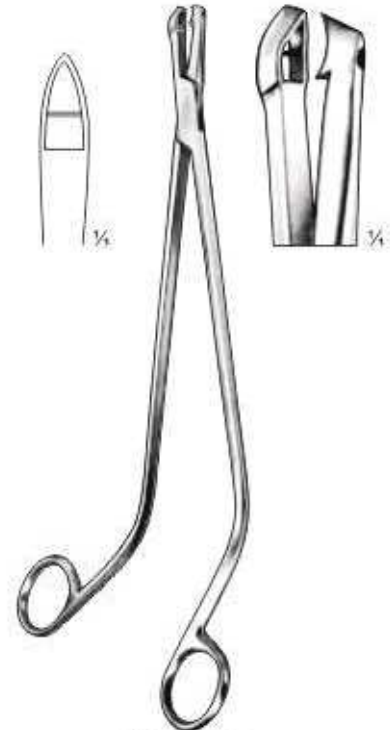
**SCHUBERT**  
 Z-23-510-260  
 26 cm, 10 1/4"

**TISCHLER**  
 Z-23-511-270  
 27 cm, 10 1/2"

**UTERINE BIOPSY FORCEPS**

Probeexzisionszangen  
Pinzas para biopsia

Pinces pour biopsi  
Pinze per biopsia



**SCHUMACHER-NAN-DOREN**  
Z-23-512-240 Fig. 1  
Z-23-513-240 Fig. 2  
24 cm, 9 1/2"



**VAN DOREN**  
Z-23-514-250  
25 cm, 10"



**VAN DOREN**  
Z-23-515-250  
25 cm, 10"



**NAEGELE**  
Z-23-516-250  
25 cm, 10"



**SMELLIE**  
Z-23-517-250  
25 cm, 10"



**BRAUN**  
Z-23-518-300  
30 cm, 12"



**SMELLIE**  
Z-23-519-300  
30 cm, 12"

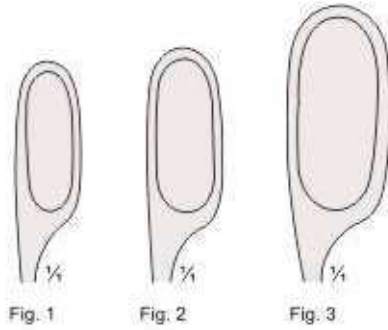

**WINTER**  
Z-23-520-280 Fig. 1  
Z-23-521-280 Fig. 2  
Z-23-522-280 Fig. 3  
28 cm, 11"



**WINTER**  
Z-23-523-280 Fig. 1  
Z-23-524-280 Fig. 2  
Z-23-525-280 Fig. 3  
28 cm, 11"

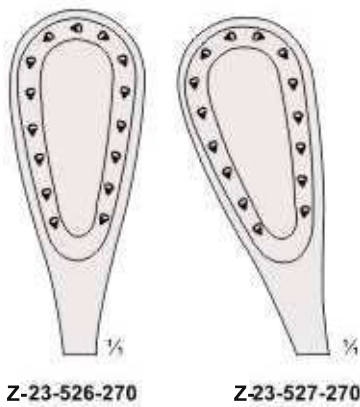

**SAENGER**  
27 cm, 10 1/2"

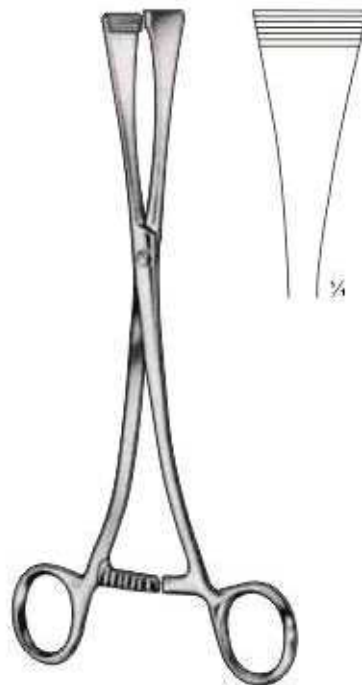

**GREEN-ARMYTAGE**  
Z-23-528-210  
21 cm, 8 1/4"



**WALLICH**  
Z-23-529-420  
42 cm, 16 1/2"



**GREEN-ARMYTAGE**  
Z-23-530-220  
caesarean section haemostatic  
forceps, for edges of the transverse  
incision in the lower segment  
22 cm, 8 3/4"

**WILLETT**  
Z-23-531-185  
Scalpel Flap Forceps  
18.5 cm, 7 1/4"

**GAUSS**  
Z-23-532-260  
Scalpel Flap Forceps  
26 cm, 10 1/4"

**PELVIMETER, OBSTETRICAL FORCEPS**

Beckenzirkel, Geburtszangen  
Pelvimetro, Forceps obstétricos

Pelvimètre, Forceps obstétriques  
Pelvimetri, Forcipi obstetrici

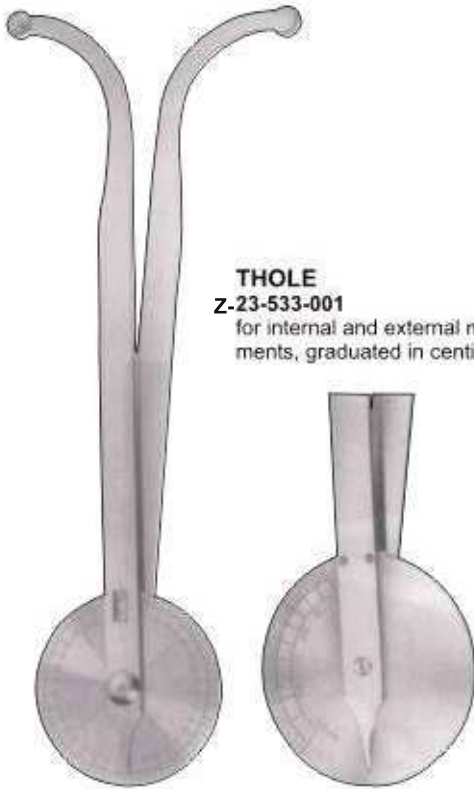

**THOLE**  
Z-23-533-001  
for internal and external measurements, graduated in centimeters

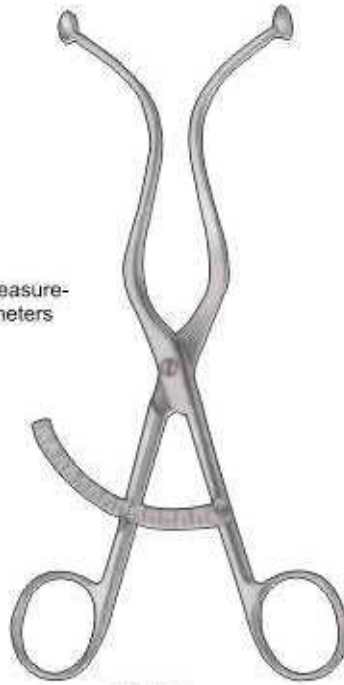

**DE LEE**  
Z-23-534-001  
graduated in centimeters and inches



**COLLIN**  
Z-23-535-001  
graduated in centimeters



**MARTIN**  
Z-23-536-001  
graduated in centimeters



for internal measurements between symphysis and promontory



**COLLIN**  
Z-23-537-001  
graduated in centimeters

The additional straight arm can be replaced. The pelvimeter with straight arm is used for localisation of the portio vaginalis uteri and of vaginal metastasis.



**BREISKY**  
Z-23-538-001  
graduated in centimeters



**PIPER**  
Z-23-539-440  
44 cm, 18"



**NAEGELE**  
Z-23-540-360 36 cm, 14 1/4"  
Z-23-541-400 40 cm, 15 1/4"



**SIMPSON**  
Z-23-542-300  
30 cm, 12"

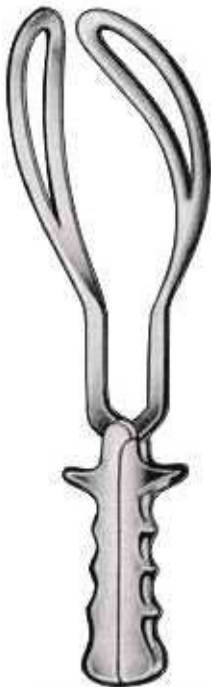

**SIMPSON-BRAUN**  
Z-23-543-330 33 cm, 13 1/2"  
Z-23-544-380 38 cm, 14 1/2"



**MCLEAN**  
Z-23-545-360  
36 cm, 14 1/4"



**KIELLAND**  
Z-23-546-410  
41 cm, 16"

Geburtszangen  
 Forceps obstétricos

Forceps obstétriques  
 Forcipi obstetrici



**KIELLAND-LUIKART**  
 Z-23-547-410  
 41 cm, 16"



**WRIGLEY**  
 Z-23-548-230  
 23 cm, 9"



**DE LEE**  
 Z-23-549-300  
 30 cm, 12"

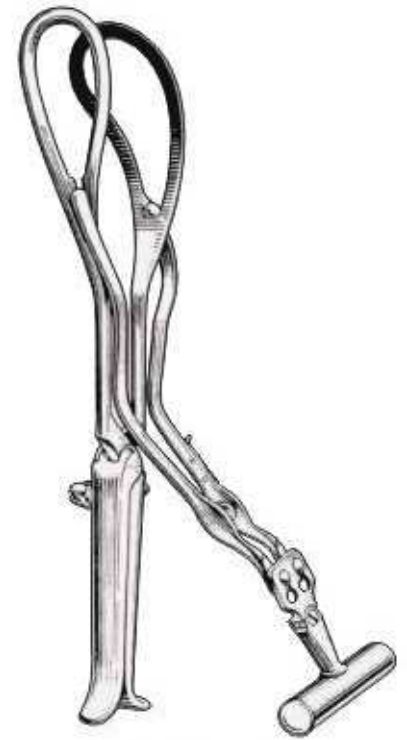

**MILNE MURRAY**  
 Z-23-550-001  
 detach-able axis traction  
 rod & handle.

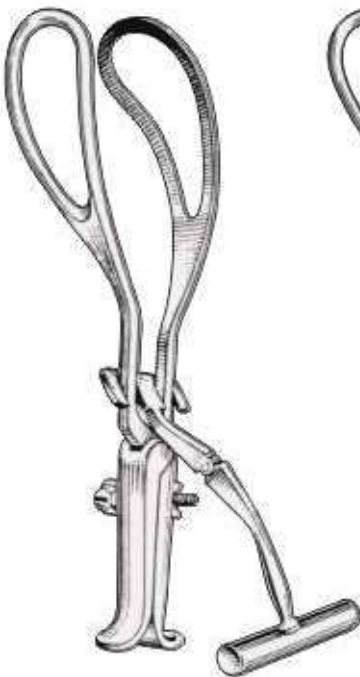

**HAIG FERGUSON**  
 Z-23-551-001  
 detachable axis traction  
 rod & handle.

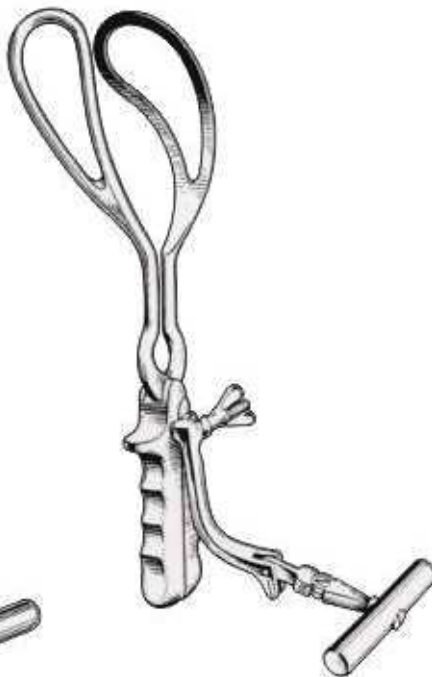

**BARNES-NEVILLE**  
 Z-23-552-001  
 Simpson handles, detachable  
 axis traction rod and handle.



**BRAUN**  
 Z-23-553-420  
 42 cm, 16 1/4"



**TARNIER**  
 Z-23-554-440  
 44 cm, 17 1/4"



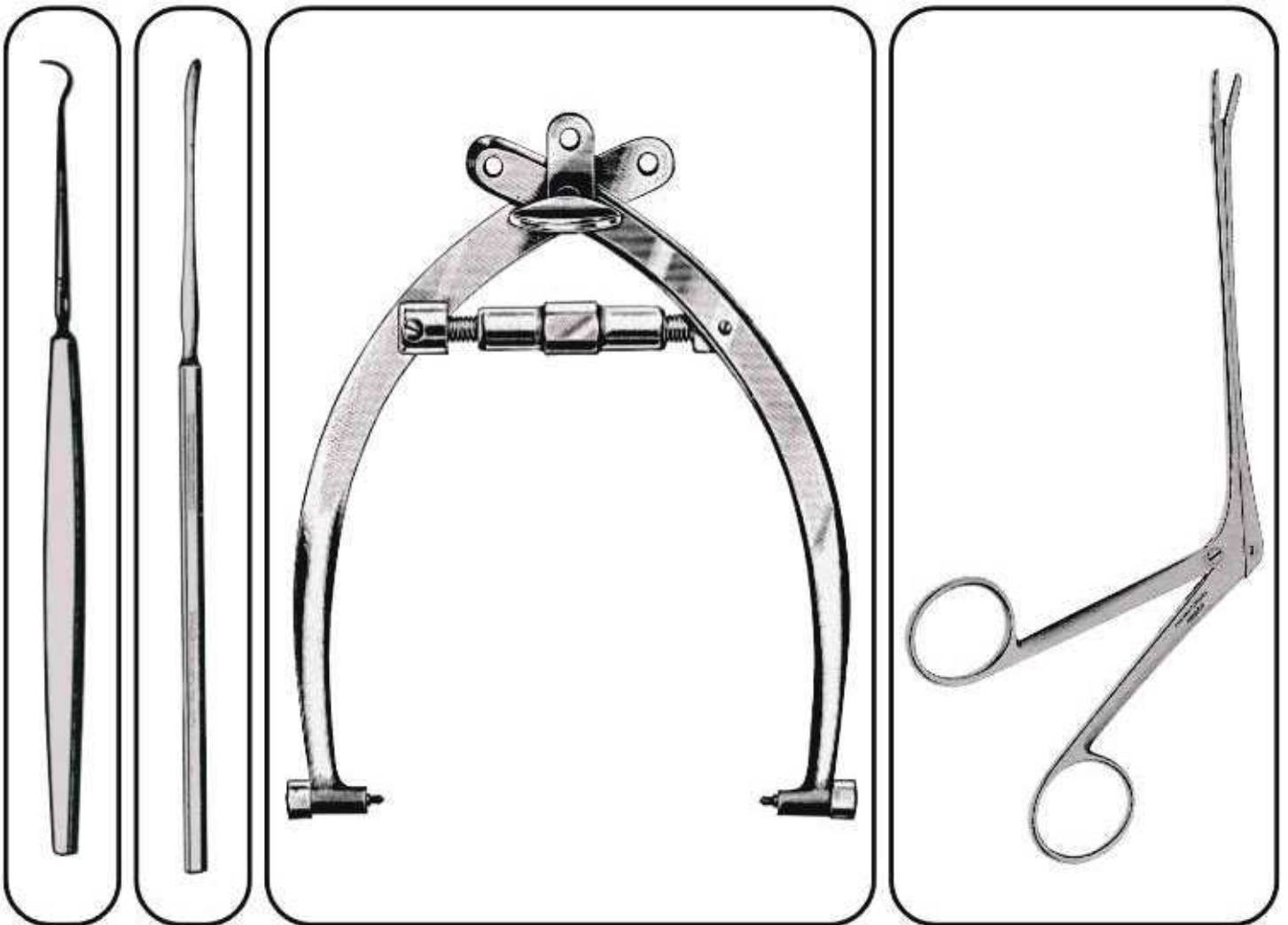

RHOTON-MERZ-Reaktorensatz

Jeu d'écarteurs du cerveau de RHOTON-MERZ

Set di divaricatori cerebrali RHOTON-MERZ

Juego de retractores cerebrales RHOTON-MERZ



**Z-25-001-000**  
wire cable only



**Z-25-002-001**  
Support only,  
flat brain spatulas,



**Z-25-003-002**  
Support only,  
for brain spatulas  
with round shaft  
up to 5.5 mm diam.  
Fixing for flexible



**RIECHERT**  
**Z-25-004-003**  
Fixation base, for skull  
mounting, holding 1  
flexible arms



**RIECHERT**  
**Z-25-005-004**  
Fixation base, for skull  
mounting, holding 2  
flexible arms



**Z-25-006-005**  
Fixation base, for skull  
mounting, holding 1  
flexible arms

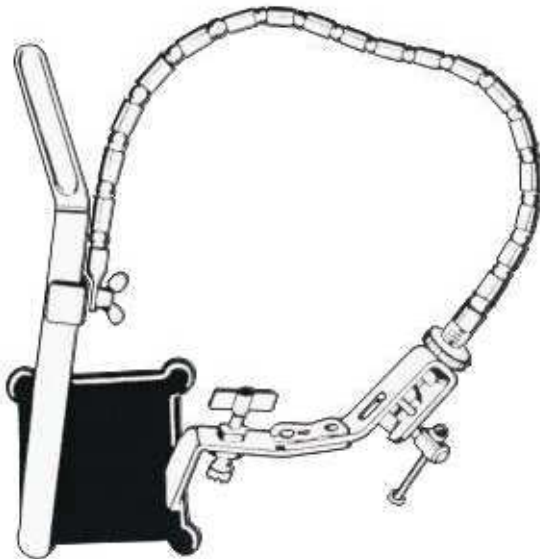

**LEYLA**  
Self-Retaining Brain Retractor  
with 1 flexible arm, complete consisting of  
**Z-25-007-001**  
**Z-25-008-002**  
**Z-25-009-003**

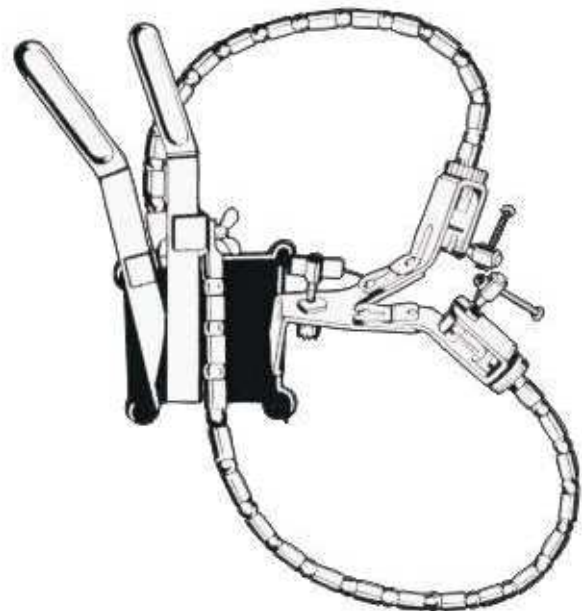

**LEYLA**  
Self-Retaining Brain Retractor  
with 2 flexible arms, complete consisting of  
**Z-25-010-001**  
**Z-25-011-002**  
**Z-25-012-003**

# Hand drill, TWIST DRILLS, SPHERICAL BURRS

Handbohrapparate, Spiralbohrer, Kugelfräser

Perforadores de mano, Brocas espirales, Taladros esféricos

Perforateurs à main, Meches hélicoïdales, Fraises sphériques

Perforatori a mano, Punte a spirale, Frese sferiche

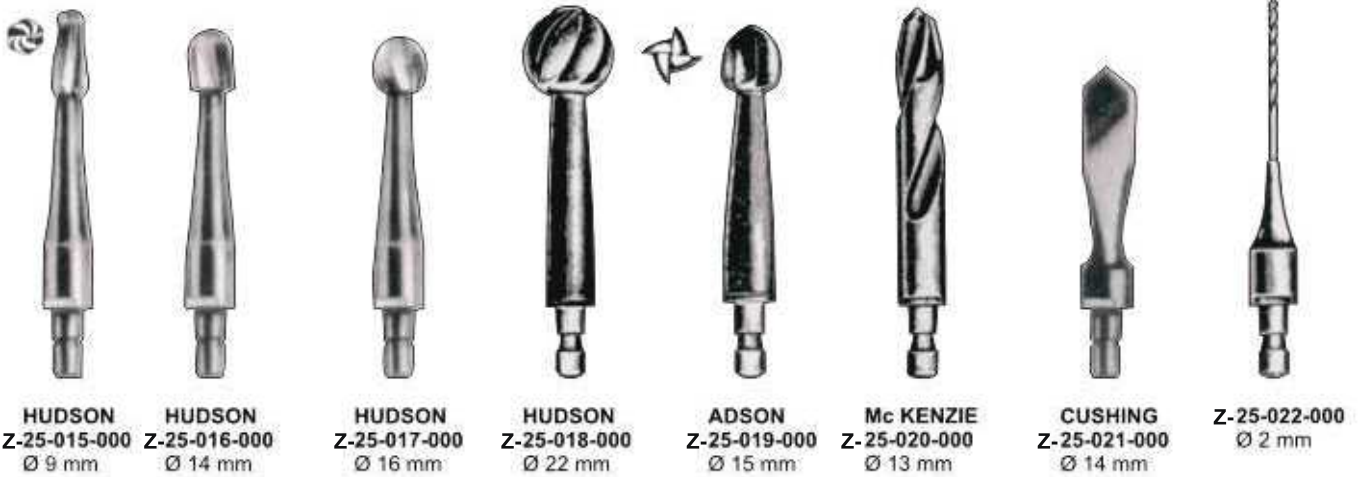
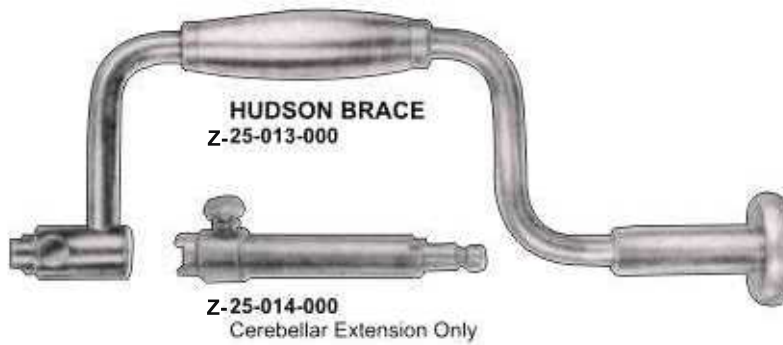

Z-25-023-000 Ø 12,5 mm  
Z-25-024-000 Ø 16 mm  
Z-25-025-000 Ø 19 mm

Schadelhalter  
Estribos De Tracción Craneal

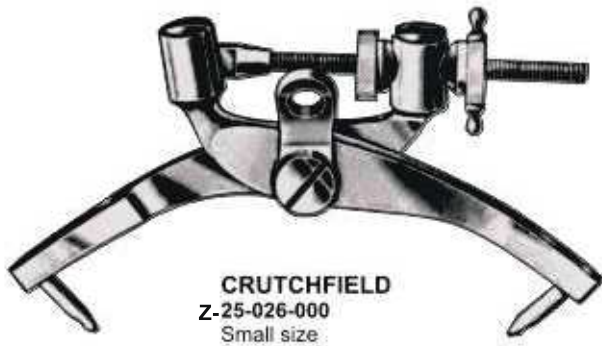

**CRUTCHFIELD**  
Z-25-026-000  
Small size

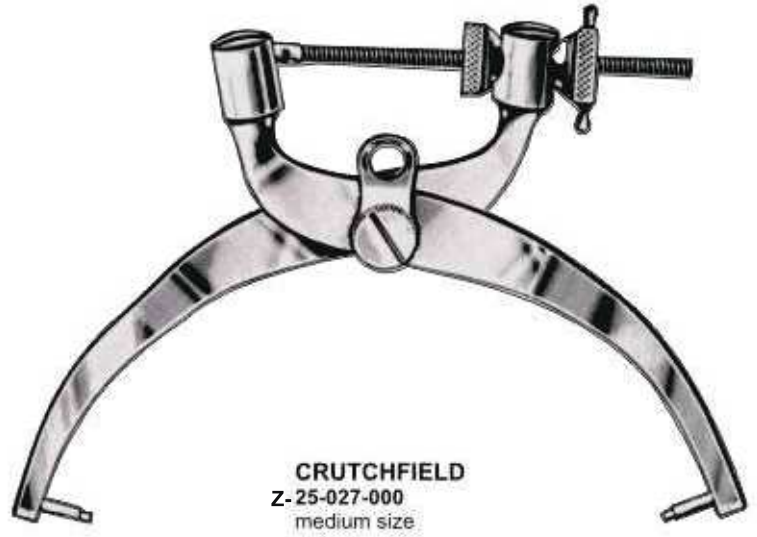

**CRUTCHFIELD**  
Z-25-027-000  
medium size



Z-25-028-000  
Drill points only



Z-25-029-000



**CRUTCHFIELD**  
Z-25-030-000  
Large size

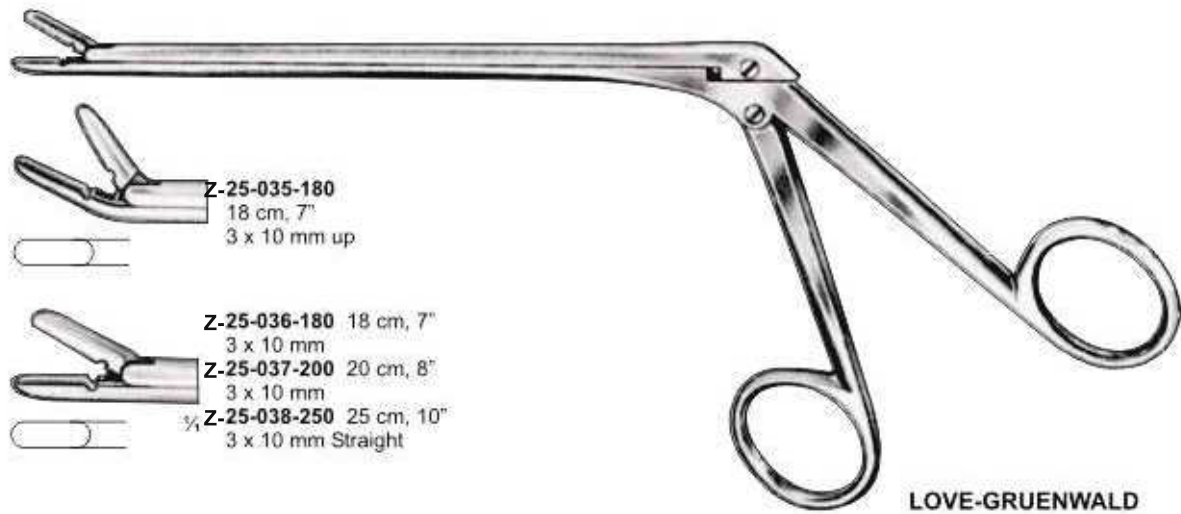
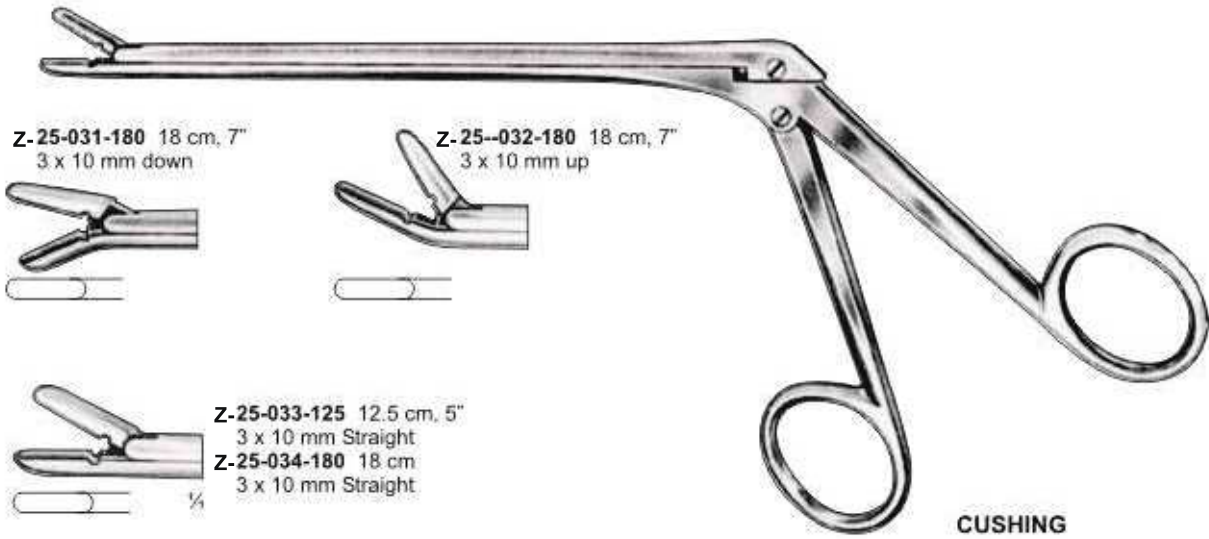

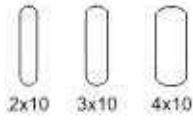

Straight Shaft	120 mm	150 mm	180 mm
Bite 2 x 10 mm	<b>Z-25-041-00</b>	<b>Z-25-044-00</b>	<b>Z-25-047-00</b>
Bite 3 x 10 mm	<b>Z-25-042-00</b>	<b>Z-25-045-00</b>	<b>Z-25-048-00</b>
Bite 4 x 10 mm	<b>Z-25-043-00</b>	<b>Z-25-046-00</b>	<b>Z-25-049-00</b>



Angled - up Shaft	120 mm	150 mm	180 mm
Bite 2 x 10 mm	<b>Z-25-050-00</b>	<b>Z-25-053-00</b>	<b>Z-25-056-00</b>
Bite 3 x 10 mm	<b>Z-25-051-00</b>	<b>Z-25-054-00</b>	<b>Z-25-057-00</b>
Bite 4 x 10 mm	<b>Z-25-052-00</b>	<b>Z-25-055-00</b>	<b>Z-25-058-00</b>



Angled - down Shaft	120 mm	150 mm	180 mm
Bite 2 x 10 mm	<b>Z-25-059-00</b>	<b>Z-25-062-00</b>	<b>Z-25-065-00</b>
Bite 3 x 10 mm	<b>Z-25-060-00</b>	<b>Z-25-063-00</b>	<b>Z-25-066-00</b>
Bite 4 x 10 mm	<b>Z-25-061-00</b>	<b>Z-25-064-00</b>	<b>Z-25-067-00</b>

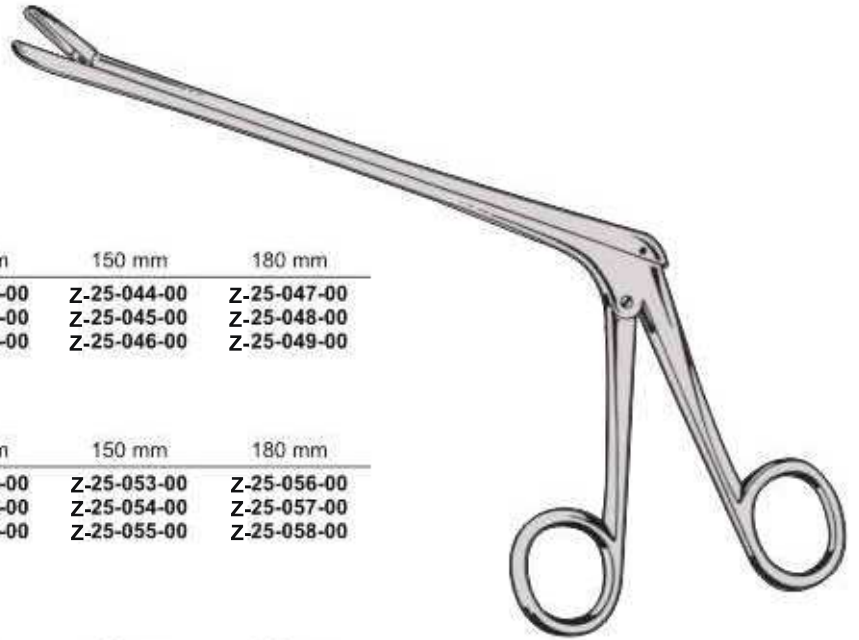

**CUSHING  
LOVE - GRUENWALD  
SPURLING**



**Z-25-068-00**  
Straight



**Z-25-069-00**  
Angled-up



**Z-25-070-00**  
Angled-down





Shaft 150 mm  
Bite 6 x 10 mm



**CLOWARD-TYPE**  
Serrated cup jaws



SPURLING

-  **Z-25-071-150** 15 cm, 6"  
4 x 10 mm
-  **Z-25-072-180** 18 cm, 7"  
4 x 10 mm
-  **Z-25-073-200** 20 cm, 8"  
Straight 4 x 10 mm

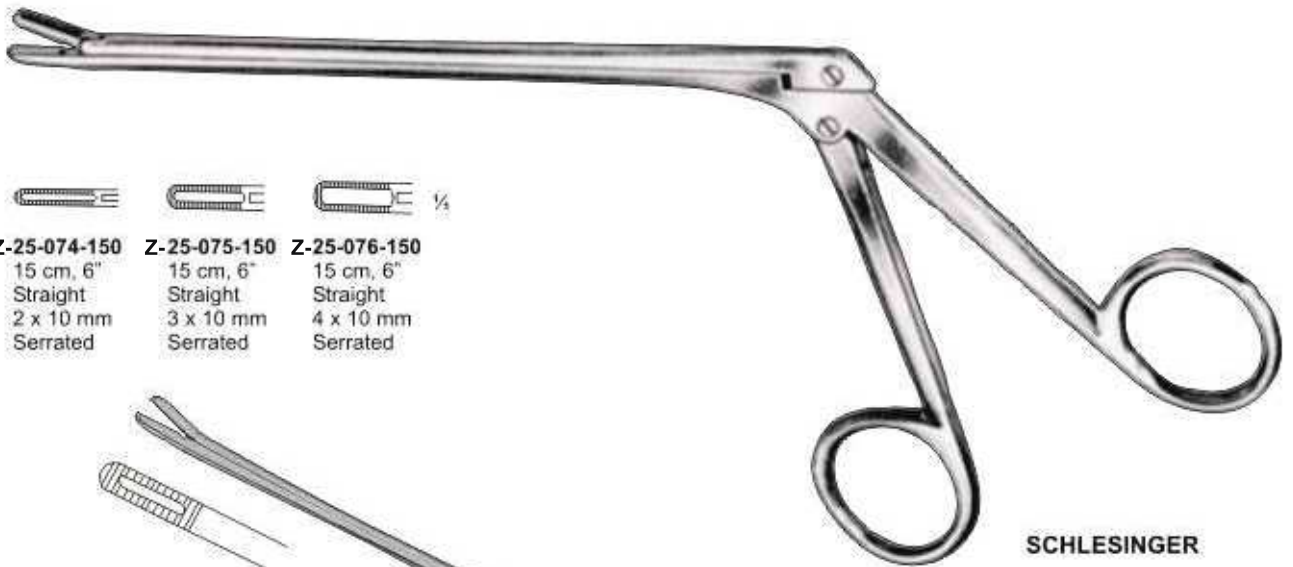

SCHLESINGER

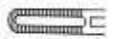
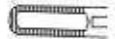
-  **Z-25-074-150** 15 cm, 6"  
Straight  
2 x 10 mm  
Serrated
-  **Z-25-075-150** 15 cm, 6"  
Straight  
3 x 10 mm  
Serrated
-  **Z-25-076-150** 15 cm, 6"  
Straight  
4 x 10 mm  
Serrated



Straight

- | Shaft          | 120 mm             | 180 mm             |
|----------------|--------------------|--------------------|
| Bite 2 x 10 mm | <b>Z-25-077-00</b> | <b>Z-25-080-00</b> |
| Bite 3 x 10 mm | <b>Z-25-078-00</b> | <b>Z-25-081-00</b> |
| Bite 4 x 10 mm | <b>Z-25-079-00</b> | <b>Z-25-082-00</b> |

SCHLESINGER

Laminektomieztangen  
 Pinzas Para Laminectomia

Pinces Pour Laminectomie  
 Pinze Per Laminectomia

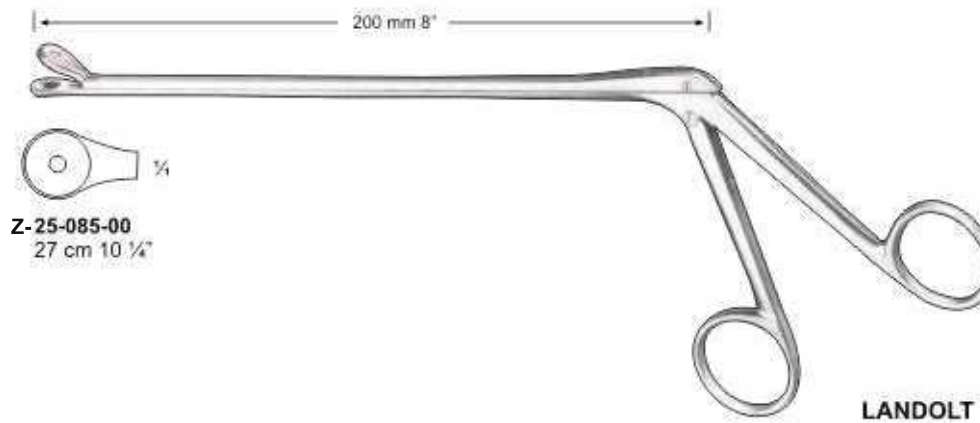
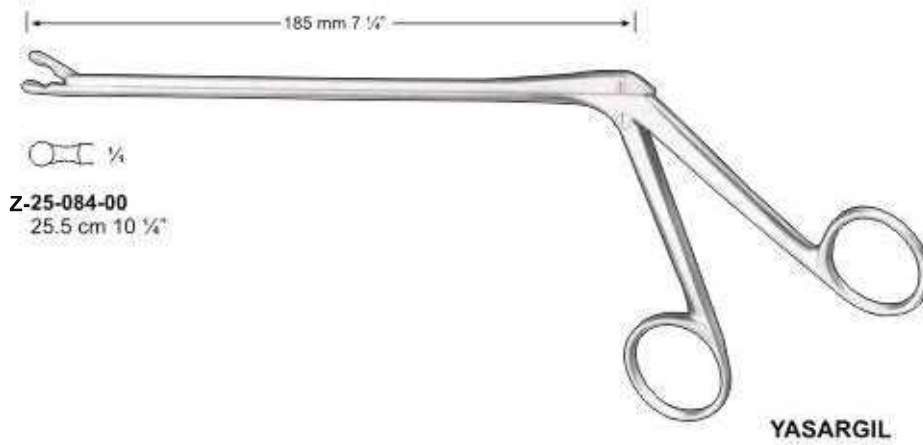
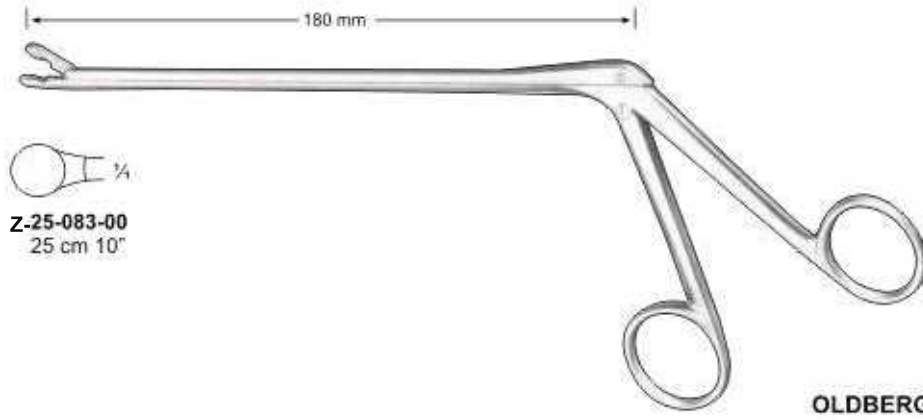



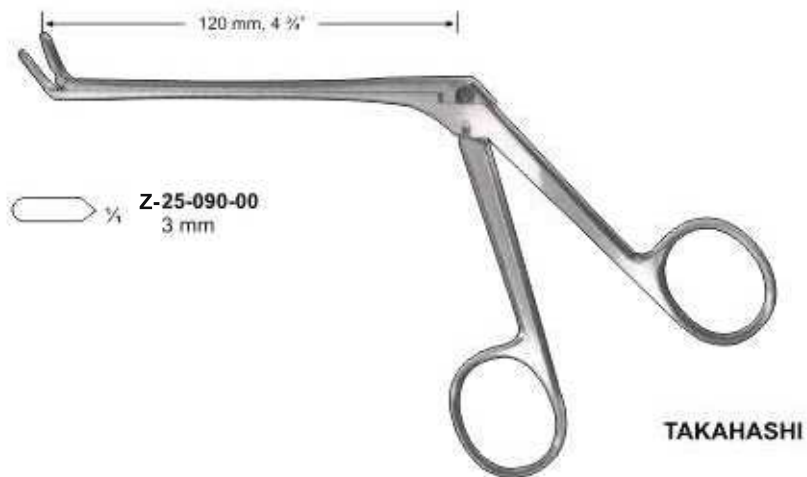
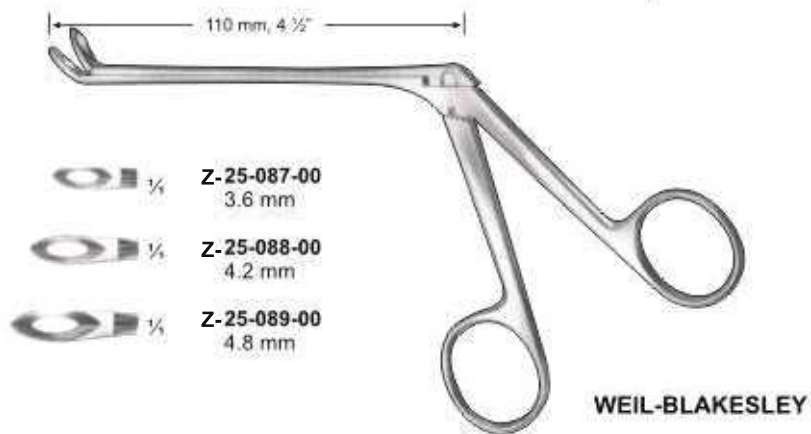
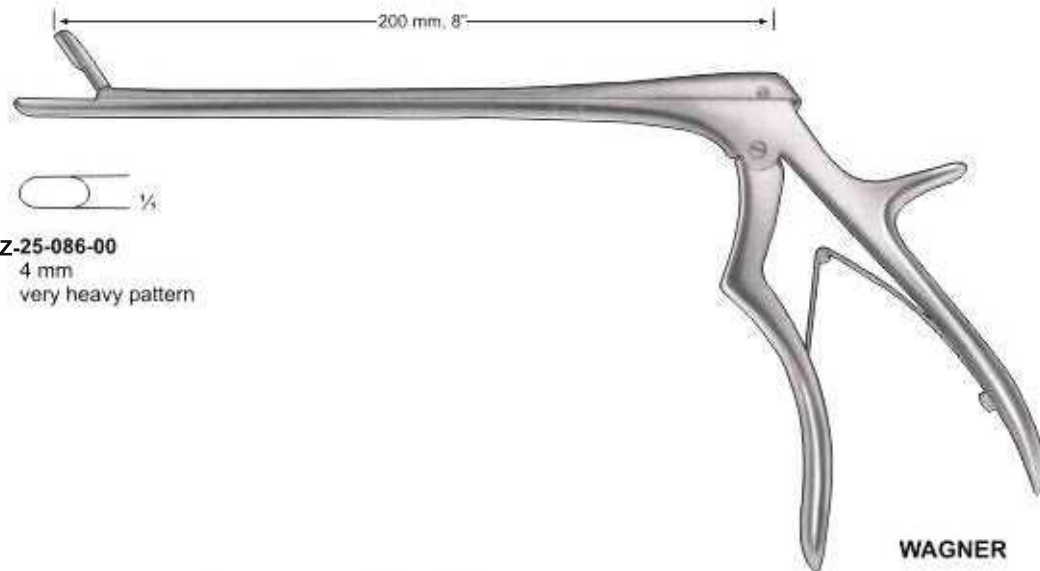

# LAMINECTOMY RONGEURS **ZIANA** INDUSTRIES

Laminektomieztangen  
Pinzas Para Laminectomía

Pinces Pour Laminectomie  
Pinze Per Laminectomia

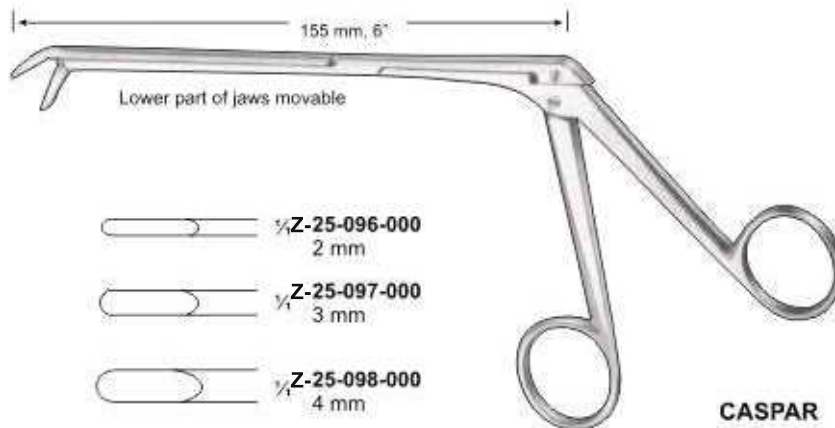
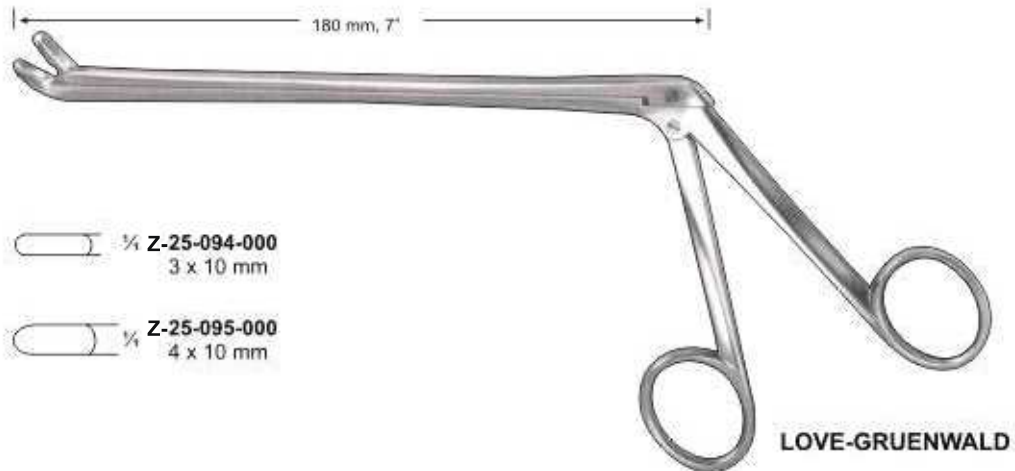
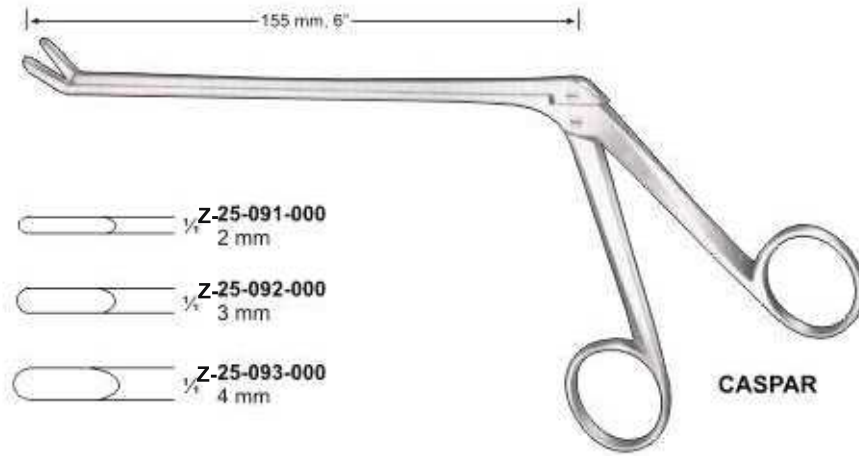

2.0 mm 3.0 mm 3.5 mm



90°  
Up-cutting  
Shaft 140 mm  
Bite 2.0 mm **25-099-000**  
Bite 3.0 mm **25-100-000**  
Bite 3.5 mm **25-101-000**



90°  
Down-cutting  
Shaft 140 mm  
Bite 2.0 mm **25-102-000**  
Bite 3.0 mm **25-103-000**  
Bite 3.5 mm **25-104-000**

160 mm, 6 1/4"



**HAJEK-KOFLER**  
**Z-25-105-000**  
3.5 mm

**HAJEK-KOFLER**

1.0 mm  
2.5 mm  
4.0 mm

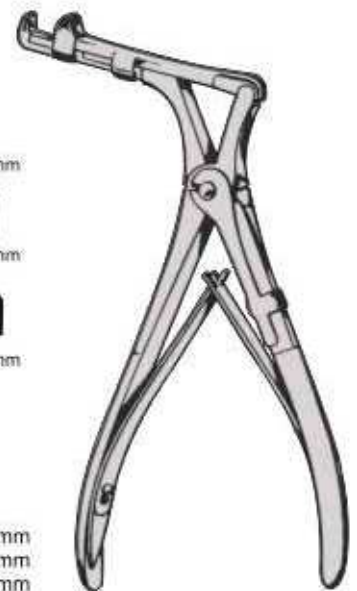

**CITELLI**  
**Z-25-106-000** 1.0 mm  
**Z-25-107-000** 2.5 mm  
**Z-25-108-000** 4.0 mm



LOVE-KERRISON  
LAMINECTOMY PUNCH

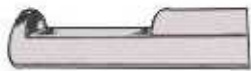

Forward 90° Regular Footplate

- 2 mm bite forward  
**Z-25-109-000** 150 mm  
**Z-25-110-000** 200 mm

- 3 mm bite forward  
**Z-25-111-000** 150 mm  
**Z-25-112-000** 200 mm

- 4 mm bite forward  
**Z-25-113-000** 150 mm  
**Z-25-114-000** 200 mm

- 5 mm bite forward  
**Z-25-115-000** 150 mm  
**Z-25-116-000** 200 mm

- 6 mm bite forward  
**Z-25-117-000** 150 mm  
**Z-25-118-000** 200 mm



Up 40° Regular footplate

- 2 mm bite up  
**Z-25-119-000** 150 mm  
**Z-25-120-000** 200 mm

- 3 mm bite up  
**Z-25-121-000** 150 mm  
**Z-25-122-000** 200 mm

- 4 mm bite up  
**Z-25-123-000** 150 mm  
**Z-25-124-000** 200 mm

- 5 mm bite up  
**Z-25-125-000** 150 mm  
**Z-25-126-000** 200 mm

- 6 mm bite up  
**Z-25-127-000** 200 mm

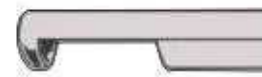

Down 90° Regular footplate

- 3 mm bite down  
**Z-25-128-000** 150 mm  
**Z-25-129-000** 200 mm

- 4 mm bite down  
**Z-25-130-000** 150 mm  
**Z-25-131-000** 200 mm

- 5 mm bite down  
**Z-25-132-000** 150 mm  
**Z-25-133-000** 200 mm



**THIN FOOTPLATE  
KERRISON PUNCH**



Forward 90° Thin footplate

□	1 mm bite forward	
	<b>Z-25-134-000</b>	150 mm
	<b>Z-25-135-000</b>	180 mm
	<b>Z-25-136-000</b>	200 mm

□	2 mm bite forward	
	<b>Z-25-137-000</b>	150 mm
	<b>Z-25-138-000</b>	180 mm
	<b>Z-25-139-000</b>	200 mm

□	3 mm bite forward	
	<b>Z-25-140-000</b>	150 mm
	<b>Z-25-141-000</b>	180 mm
	<b>Z-25-142-000</b>	200 mm

□	4 mm bite forward	
	<b>Z-25-143-000</b>	150 mm
	<b>Z-25-144-000</b>	180 mm
	<b>Z-25-145-000</b>	200 mm

□	5 mm bite forward	
	<b>Z-25-146-000</b>	150 mm
	<b>Z-25-147-000</b>	180 mm
	<b>Z-25-148-000</b>	200 mm



Up 40° Thin footplate

□	1 mm bite up	
	<b>Z-25-149-000</b>	180 mm

□	2 mm bite up	
	<b>Z-25-150-000</b>	180 mm

□	3 mm bite up	
	<b>Z-25-151-000</b>	180 mm

□	4 mm bite up	
	<b>Z-25-152-000</b>	180 mm

□	5 mm bite up	
	<b>Z-25-153-000</b>	180 mm

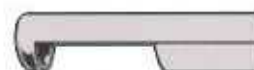

Down 90° Thin footplate

□	1 mm bite down	
	<b>Z-25-154-000</b>	180 mm

□	2 mm bite down	
	<b>Z-25-155-000</b>	180 mm

□	3 mm bite down	
	<b>Z-25-156-000</b>	180 mm

□	4 mm bite down	
	<b>Z-25-157-000</b>	180 mm

□	5 mm bite down	
	<b>Z-25-158-000</b>	180 mm

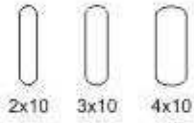

**Straight**  
 Shaft 180 mm  
 Bite 2 x 10 mm **Z-25-159-000**  
 Bite 3 x 10 mm **Z-25-160-000**  
 Bite 4 x 10 mm **Z-25-161-000**



**Angled - up**  
 Shaft 180 mm  
 Bite 2 x 10 mm **Z-25-162-000**  
 Bite 3 x 10 mm **Z-25-163-000**  
 Bite 4 x 10 mm **Z-25-164-000**



**Angled - down**  
 Shaft 180 mm  
 Bite 2 x 10 mm **Z-25-165-000**  
 Bite 3 x 10 mm **Z-25-166-000**  
 Bite 4 x 10 mm **Z-25-167-000**

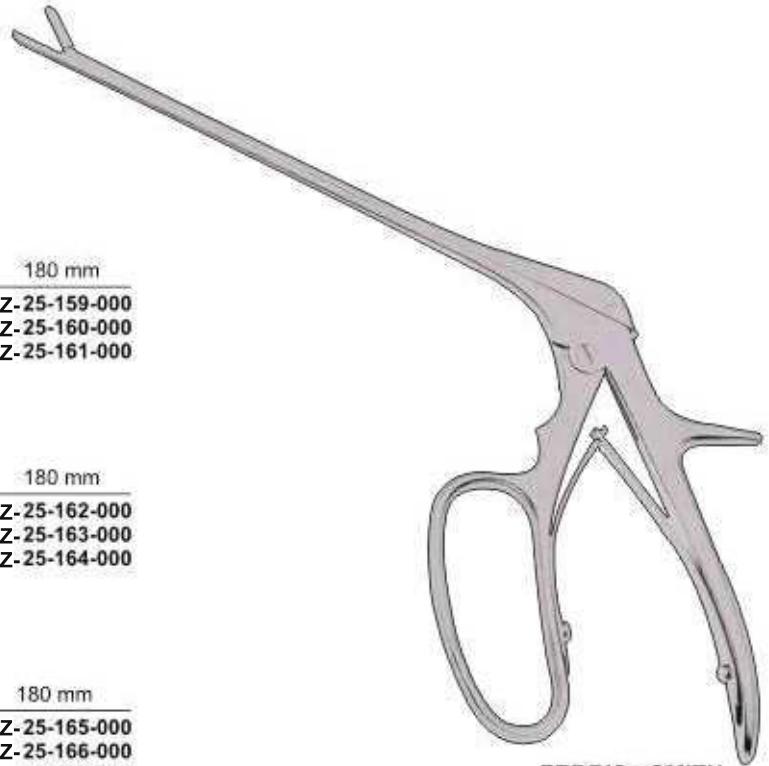

**FERRIS - SMITH**

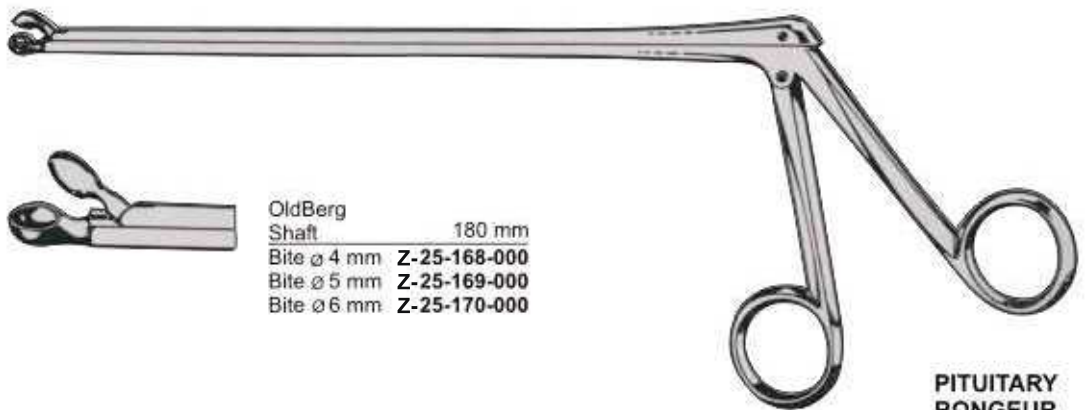

**OldBerg**  
 Shaft 180 mm  
 Bite  $\varnothing$  4 mm **Z-25-168-000**  
 Bite  $\varnothing$  5 mm **Z-25-169-000**  
 Bite  $\varnothing$  6 mm **Z-25-170-000**

**PITUITARY RONGEUR**

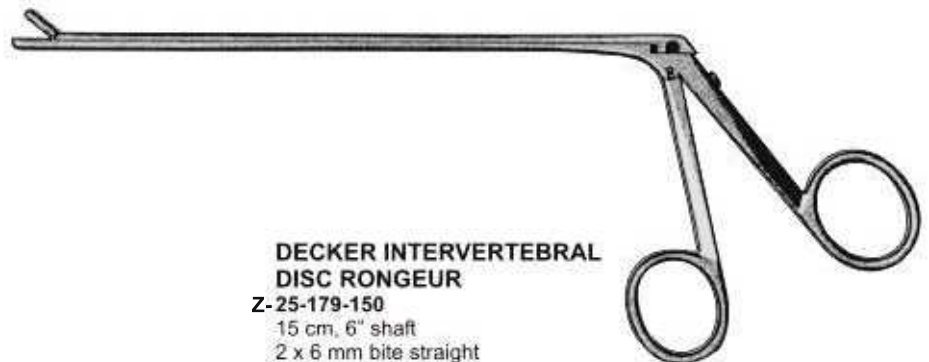
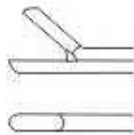
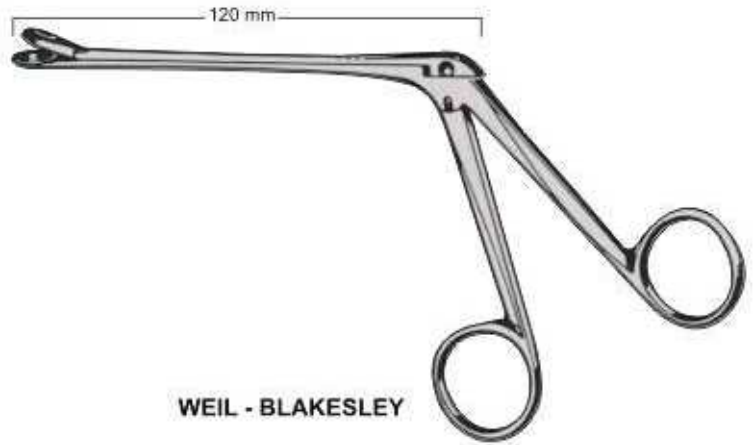
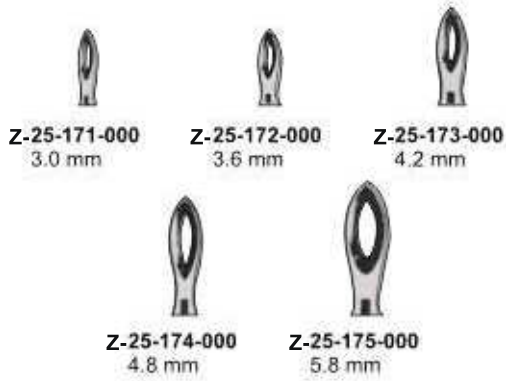



Working length 14 mm



**MICRO GRASPING FORCEPS**  
 Z-25-180-000  
 serrated, straight



**MICRO ALLIGATOR SCISSORS**  
 Z-25-181-000  
 straight



**Z-25-182-000**  
 Ø1.0 mm  
 Straight



**Z-25-183-000**  
 Ø2.0 mm  
 Straight



**Z-25-184-000**  
 Ø3.0 mm  
 Straight



**MIRCO CUP FORCEPS**



**Z-25-185-000**  
 Ø1.0 mm  
 angled up



**Z-25-186-000**  
 Ø2.0 mm  
 curved to right



**Z-25-187-000**  
 Ø3.0 mm  
 curved to left



**Z-25-188-180**  
 Grasping Forceps  
 Ø3 mm



**Z-25-189-180**  
 Cup Forceps  
 Ø2 mm



**Z-25-190-180**  
 Alligator Scissors  
 Ø2 mm



**MICRO ALLIGATOR FORCEPS**  
 with tubular shaft  
 18 cm, 7"



Duramesser, Durahaken,  
Durahaken, Nerv-und Gefäßhäkchen

Couteaux Pour Dure-mere, Crochets Pour Dure-mère,  
Crochets Pour Dure-mère, Crochets à Nerfs Et à Vaisseaux



**SCOVILLE**  
Z-25-191-300  
30 cm, 12"  
Nerve Hook and  
Dissector



**SCOVILLE**  
Z-25-192-300  
30 cm, 12"  
Nerve Hook and  
Dissector



**SCOVILLE**  
Z-25-193-300  
30 cm, 12"  
Sympathectomy Hook  
and Dissector



Z-25-194-190  
Davis  
4 mm, 19 cm, 7 1/2"



Z-25-195-200  
Sachs  
3 mm, 20 cm, 8"



Z-25-196-200  
Sachs  
6 mm, 20 cm, 8"

**NERVE SEPARATOR & SPATULA**



**FRAZIER**  
Z-25-197-125  
12.5 cm, 5"



**GILLIES**  
19 cm, 7 1/2"



25-198-190  
Small



25-199-190  
large



Z-25-200-130  
Straight  
13 cm, 5"



**LAHEY CLINIC**  
Z-25-201-130  
13 cm, 5"



**SACHS**  
Z-25-202-185  
18.5 cm, 7 1/2"



Z-25-203-160  
16 cm, 6 1/2"



**TOENNIS**  
Z-25-204-150  
15 cm, 6"



**DURA  
TWIST HOOK**  
25-205-140  
14 cm, 5 1/2"

# CRANIAL RONGEURS, DURA DISSECTORS



Schädelzangen, Duradissektoren

Pinces Emporte-pièces Crâniennes, Dissecteurs à Dure-mère

Pinzas Sacabocados Craneales, Disecadores Para Duramadre

Pinze Per Craniectomia, Dissettori Per La Dura-madre



**SACHS**  
Z-25-206-160  
21 cm, 8 1/4"



**MILLIGAN**  
Z-25-207-160  
21 cm, 8 1/4"



**SACHS**  
Z-25-208-160  
21 cm, 8 1/4"



**Z-25-209-160**  
22 cm, 8 1/4"



**PENFIELD**  
Z-25-210-160  
17.5 cm, 7"



**PENFIELD**  
Z-25-211-160  
19.5 cm, 7 3/4"



**PENFIELD**  
Z-25-212-160  
19.5 cm, 7 3/4"



**25-213-220**  
22 cm, 8 1/4"  
Straight

Schädelzangen, Duradisektoren

Pinzas Sacabocados Craneales, Disecadores Para Duramadre

Pinces Emporte-pièces Crâniennes, Dissecteurs à Dure-mère

Pinze Per Craniectomia, Dissettori Per La Dura-madre



**RANEY**  
Z-25-214-160  
16 cm, 6 1/4"



**RANEY**  
Z-25-215-017  
1.7cm, 3/4"

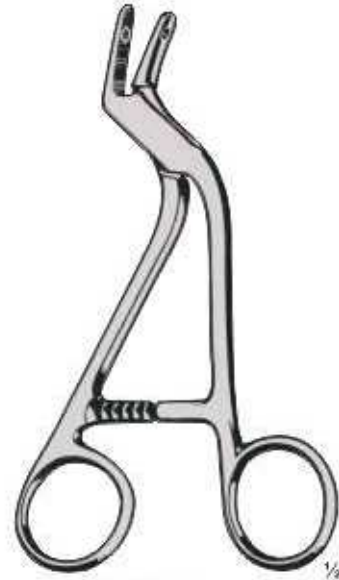

**ADSON**  
Z-25-216-150  
15 cm, 6"  
Drill Guide and  
Dura Protector



**CONE**  
Z-25-217-200 20 cm 8"  
Z-25-218-230 23 cm 9"  
Skull Punch



**DAHLGREN**  
Z-25-219-200  
20 cm, 8"  
Complete with 2 Blades



**DE VILBISS**  
Z-25-220-210  
Skull cutting forceps  
21cm, 8 1/4"



**INGE**  
Z-25-221-160  
16 cm, 6 1/2"  
Small pattern

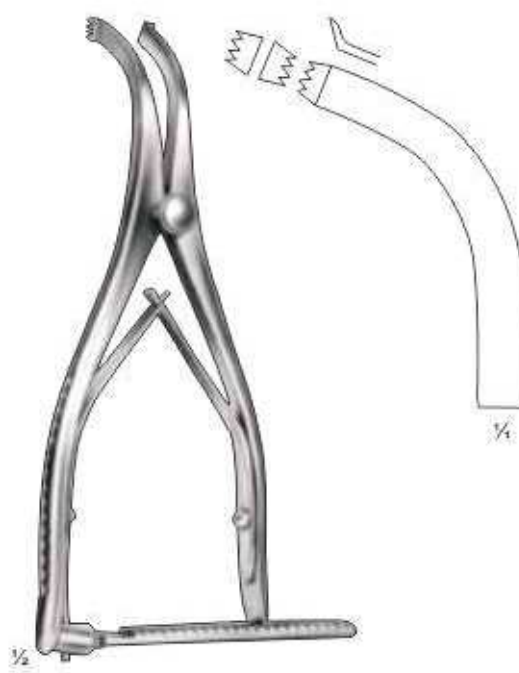

**INGE**  
Z-25-222-170  
17 cm, 6 3/4"



**INGE** 26 cm, 10 1/4"  
Z-25-223-260 Jaw width 5 mm  
Z-25-224-260 Jaw width 10 mm  
large pattern



**CLOWARD**  
Z-25-225-130  
Z-13 cm, 5"



**LUMBAR LAMINA SPREADER**  
Z-25-226-00  
arm length: 87.5 mm  
spread: 37.5 mm



**CLOWARD**  
Z-25-227-160  
16 cm, 6 1/2"



**Z-25-228-140**  
14 cm, 5 1/2"

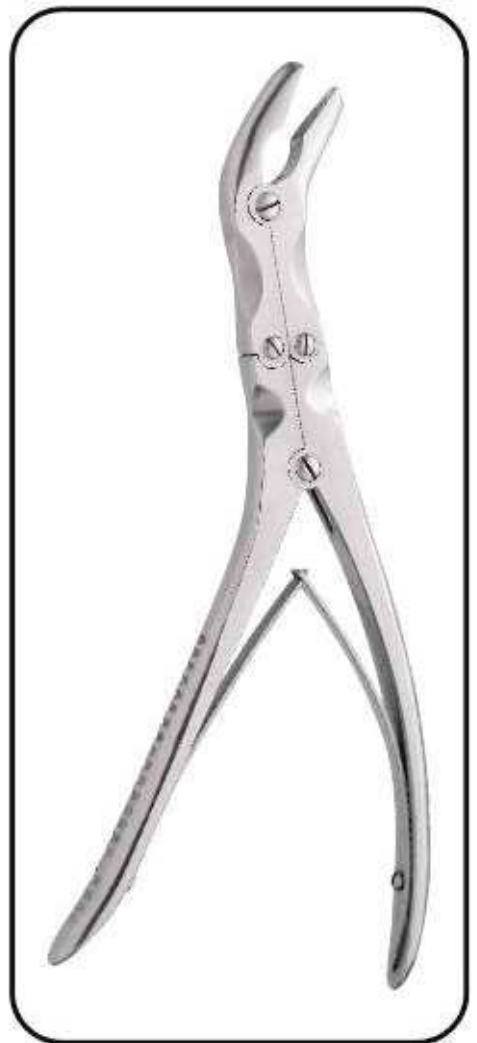
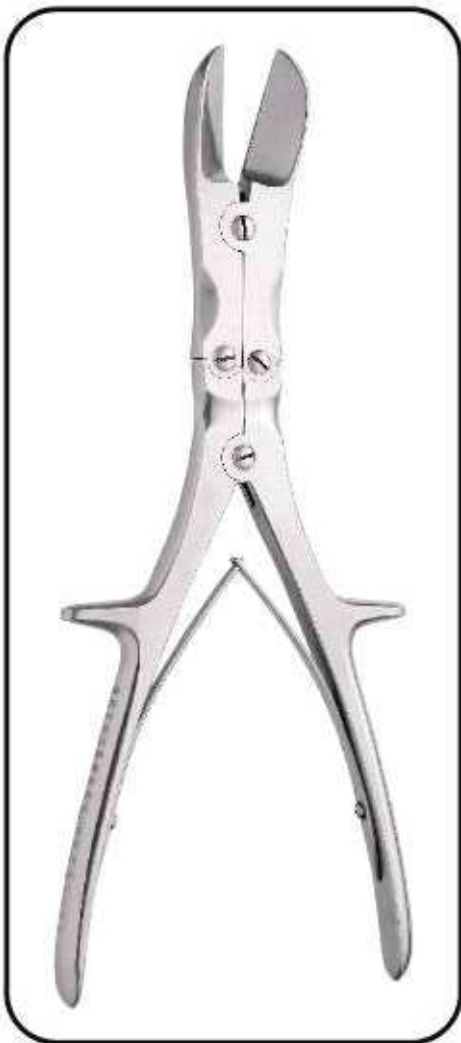

**DRILL BITS / TAPS / COUNTERSINKS**



**DRILL BITS**

Size	Round Shaft	AO Coupling	Dental Coupling
1.1mm	26-001-11	26-012-11	26-023-11
1.5 mm	26-002-15	26-013-15	26-024-15
2.0 mm	26-003-20	26-014-20	26-025-20
2.5 mm	26-004-25	26-015-25	26-026-25
2.7 mm	26-005-27	26-016-27	26-027-27
3.2 mm	26-006-32	26-017-32	26-028-32
3.2 mm(long)	26-007-32L	26-018-32L	26-029-32L
3.5 mm	26-008-35	26-019-35	26-030-35
3.5 mm(long)	26-009-35L	26-020-35L	26-031-35L
4.5 mm	26-010-45	26-021-45	26-032-45
4.5 mm(long)	26-011-45L	26-022-45L	26-033-45L



**TAPS**

Size	T-Handle	AO Coupling	Dental Coupling
1.5 mm			26-048-15
2.0 mm			26-049-20
2.7 mm	26-034-27	26-041-27	
3.5 mm(cortical)	26-035-35	26-042-35	
3.5 mm(cancellous)	26-036-35D	26-043-35D	
4.0 mm	26-037-40	26-044-40	
4.5 mm(short thread)	26-038-45	26-045-45	
4.5 mm(long thread)	26-039-45D	26-046-45D	
6.5 mm	26-040-65	26-047-65	



**MINI COUNTERSINK**  
Z-26-050-15  
1.5 mm Screws  
2.00 mm Diam Tip 1.1 mm



**SMALL COUNTERSINK**  
Z-26-051-27  
2.7, 3.5 mm and  
4.0 mm Screws Tip 2.0 mm



**MALLEOLAR COUNTERSINK**  
Z-26-052-45  
Tip 3.2 mm



**LARGE COUNTERSINK**  
Z-26-053-65  
4.5 mm and 6.5 diam Screws  
Tip 4.5 mm

**HANDLES**



**DENTAL**  
Handle Coupling  
Z-26-054-11



**FIBER HANDLE**  
Z-26-055-32  
AO Coupling



**T-HANDLE**  
Z- 26-056-02  
AO Coupling



**JACOB'S CHUCK**  
Z-26-057-01 T-Handle and key  
Z-26-058-02 only  
Z-26-059-03 Key



**KEY HANDLE**  
Z-26-060-15



**FIBER Key Handle**  
Z-26-061-180  
18cm, 7"

**BONE DRILLS**



**RALK**  
**Z-26-062-03**  
Hand Drill light metal case and laterally angled handle, with 3 - jaw chuck and key, opening up to 6.35 mm diameter

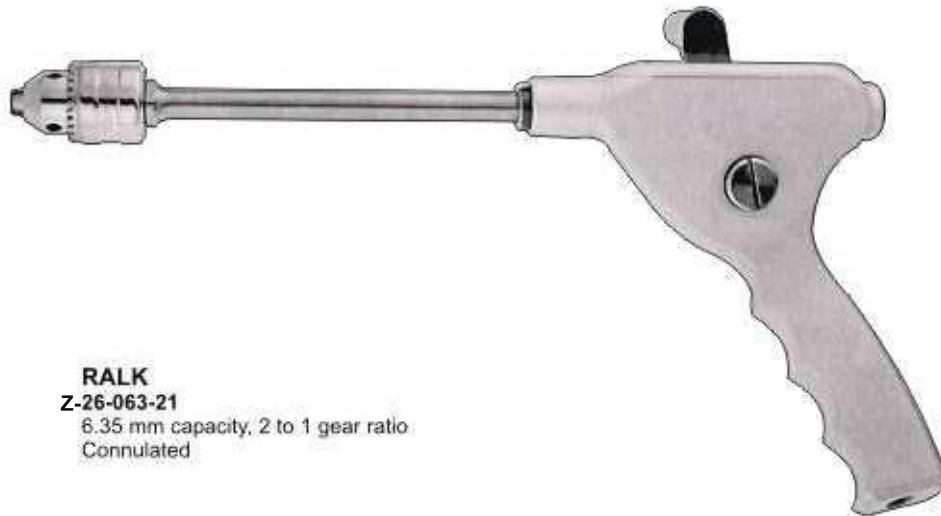

**RALK**  
**Z-26-063-21**  
6.35 mm capacity, 2 to 1 gear ratio  
Connulated



**BONE DRILLS**



**HUDSON**  
Z-26-064-000



**Fig. 1**  
Z-26-065-01



**Fig. 2**  
Z-26-066-02



**Fig. 3**  
Z-26-067-03



**CUSHING**  
Z-26-068-07



Z-26-069-13

SCREW DRIVERS



**SCREW DRIVER**  
Z-26-070-20  
single head



**SCREW DRIVER**  
Z-26-071-48  
philips head



**SCREW DRIVER**  
Z-26-072-10  
slotted head



**WILLIAMS**  
Screw Driver



Z-26-073-06  
Phillips Head



Z-26-074-06  
Slotted Head



Z-26-075-06  
Single Head



Z-26-076-06  
Hexagonal Head  
3.5 mm



HEXAGONAL HEAD

Size of screws	Head Size	Fiber-Handle	AO Coupling	Dental Coupling
1.5mm	1.5mm	Z-26-077-15	Z-26-080-15	Z-26-083-15
2.0mm				
2.7mm	2.5mm	Z-26-078-25	Z-26-081-25	
3.5mm				
4.0mm				
4.5mm	3.5mm	Z-26-079-35	Z-26-082-35	
6.5mm				



**HOLDING SLEEVE**  
Z-26-084-15  
1.5 mm



**HOLDING SLEEVE**  
Z-26-085-25  
2.5 mm

**INSTRUMENTS FOR PLATING**



**DEPTH GAUGE**

- Z-26-086-15**  
1.5 mm & 2.0 mm screws
- Z-26-087-27**  
2.7 mm & 4.0 mm screws
- Z-26-088-45**  
4.5 mm & 6.5 mm screws



**SCREW FORCEPS**

**Z-26-089-001**



**SHARP HOOK**

**Z-26-090-001**



**BENDING TEMPLATE**

Size	3.5 mm	4.5 mm
5 hole		<b>26-093-05</b>
7 hole	<b>26-091-07</b>	<b>26-094-07</b>
9 hole	<b>26-092-09</b>	<b>26-095-09</b>



**COMBINATION Wrench**

**Z-26-096-11**  
width across flats 11 mm



**SOCKET WRENCH**

**Z-26-097-11**  
width across flats 11 mm



**COMPRESSION Device**

**Z-26-098-08**  
8 mm screw-type

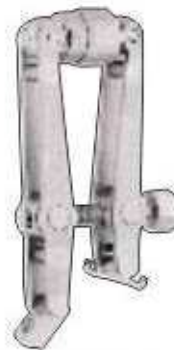

**ARTICULATED Tension Device**

**Z-26-099-20**  
with Indicator span 20 mm may also be used for distraction of standard and small plates



**PIN WRENCH**

**Z-26-100-02**  
Tension Device & Distactor



**DRILL SLEEVE**

**26-101-07**  
Tension Device

**PLATE BENDING INSTRUMENTS**



**BENDING IRON**  
Z-26-102-01  
Mini Plates



**BENDING IRONS**  
Z-26-103-02  
small plates to be  
used as a pair



**BENDING IRONS**  
Z-26-104-03  
small plates to  
be used as a pair

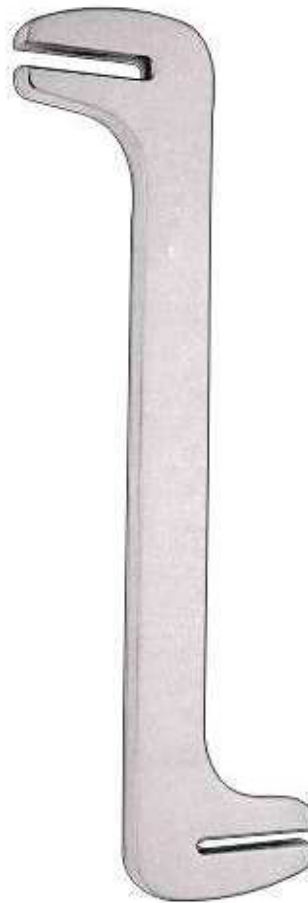

**BENDING IRON**  
Z-26-105-04  
Standard Plates Beak  
opening 4 and 6 mm



**BENDING PLIERS**  
Z-26-106-15  
1.5 and 2.0 mm Plates

**DRILL SLEEVES**



**MINI DRILL SLEEVE**  
**Z-26-107-11**  
1.1 mm and 1.5 mm drill bits  
**Z-26-108-15**  
1.5 mm and 2.0 mm drill bits



**DRILL GUIDE**  
**26-109-20**  
drill sleeve for 2.0 mm  
drill bit

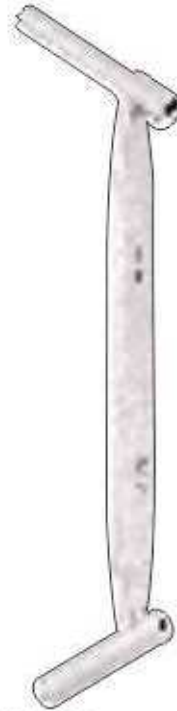

**Z-26-110-27**  
Tap Sleeve, 2.0 mm  $\phi$   
Drill Sleeve, 2.7 mm  $\phi$   
**Z-26-111-35**  
Tap Sleeve, 2.5 mm  $\phi$   
Drill Sleeve, 3.5 mm  $\phi$

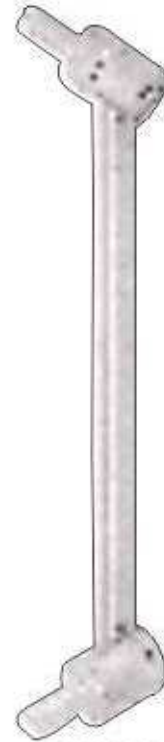

**NEUTRAL & LOAD  
DRILL GUIDE**  
**Z-26-112-20** 1.5 mm for 2.0 mm Screws  
**Z-26-113-27** 2.0 mm for 2.7 mm Screws  
**Z-26-114-35** 2.5 mm for 3.5 mm Screws  
**Z-26-115-45** 3.2 mm for 4.5 mm Screws



**TAP SLEEVE**  
**Z-26-116-35**  
3.5 mm also for used  
as 3.2 mm drill Guide



**TAP SLEEVE**  
**Z-26-117-45**  
4.5 mm



**DRILL SLEEVE**  
**Z-26-118-32**  
3.2 mm for Round  
Hole Plates

**DRILL SLEEVES**



**INSERT DRILL SLEEVE**

- Z-26-119-27 2.7 / 2.0 mm Drill Bit 2.0 mm
- Z-26-120-35 3.5 / 2.5 mm Drill Bit 2.5 mm
- Z-26-121-45 4.5 / 3.2 mm Drill Bit 3.2 mm



- DRILL Small Pointed**  
Z-26-122-35  
Drill Bit 3.5 mm



- DRILL Pointed Guide**  
Z-26-123-58  
6.5 mm

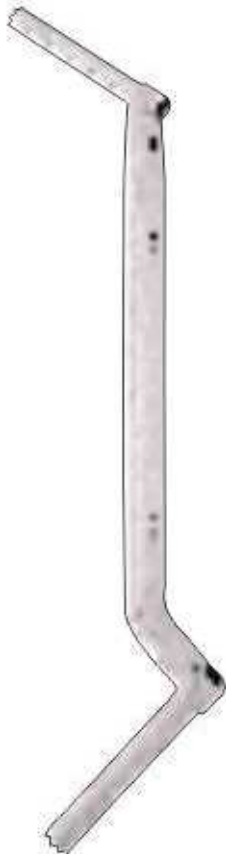

- DRILL GUIDE**  
Z-26-124-08  
4.5 mm Screws  
Drill Bit 4.5 mm &  
3.2 mm

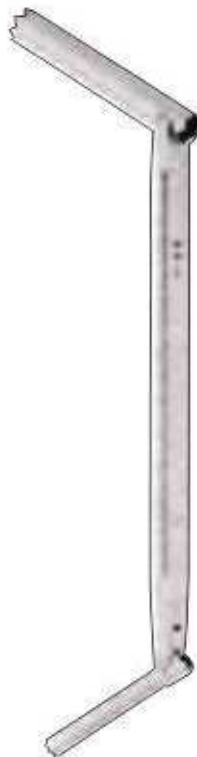

- DRILL GUIDE**  
Z-26-125-65  
6.5 mm Screws  
Drill Bit 3.2 mm



- DRILL GUIDE**  
Z-26-126-02  
3.5 mm for neutral  
and compression Positioning  
Drill Bit 2.5 mm



- C - CLAMP**  
Z-26-127-45  
Drill Guide with thread  
for Drill Bit 4.5 mm

Knochenfasszange, Repositionszangen  
Pinzas para hueso, Pinzas para reposición

Daviers porte-so, Pincas à réduction  
Tenaglie per ossa, Pinze per riposizioni

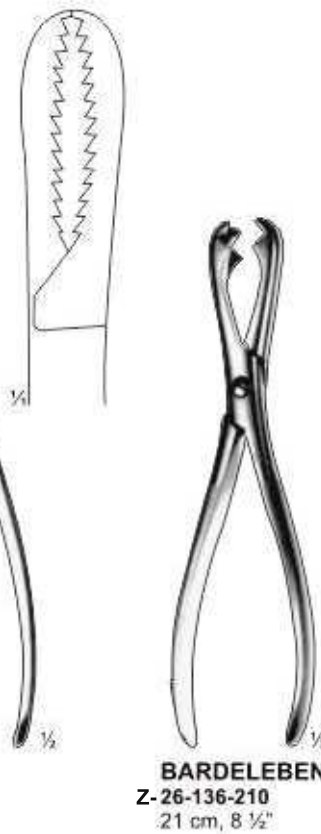
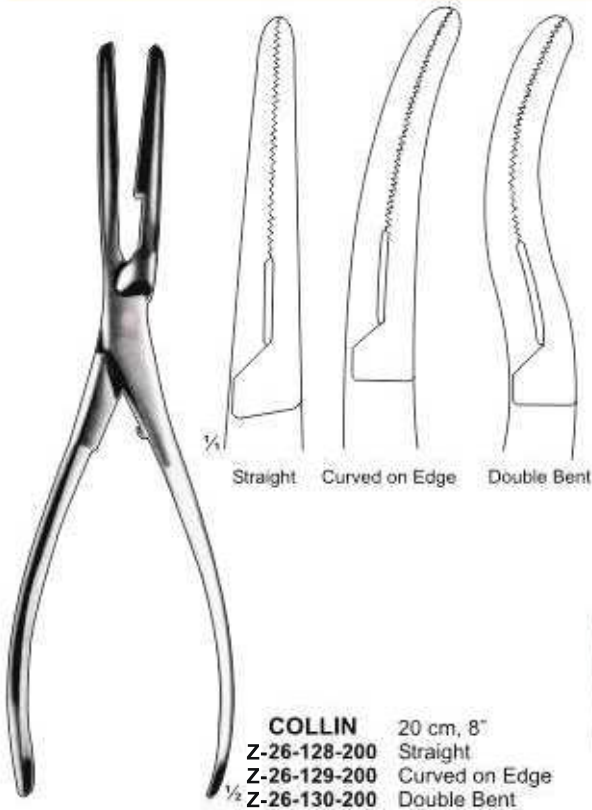

Knochenfasszange, Repositionszangen  
Pinzas para hueso, Pinzas para reposición

Daviers porte-so, Pincas à réduction  
Tenaglie per ossa, Pinze per riposizioni



**SELF-CENTERING  
BONE HOLDING FORCEPS**  
with Thread Lock

- Z-26-138-150**  
For small Fragments 15 cm, 6" jaw 9 mm
- Z-26-139-190**  
19 cm, 7 1/2" Extra small jaw 10 mm
- Z-26-140-240**  
24 cm, 9 1/2" small jaw 14 mm
- Z-26-141-260**  
26 cm, 10" medium jaw 18 mm
- Z-26-142-280**  
28 cm, 11" large jaw 23 mm



**ULRICH**

- Z-26-143-190** 19 cm, 7 1/2"
- Z-26-144-230** 23 cm, 9"
- Z-26-145-250** 25 cm, 10"
- Z-26-146-280** 28 cm, 11"



**SEMB**  
**Z-26-147-190**  
19 cm, 7 1/2"



**Z-26-148-000**  
Set includes:  
Hooked Jaws: 1 pair  
Serrated Jaws: 3 pairs  
Sizes: 32, 51 and 57 mm



**CHARNLEY  
BONE FORCEPS**  
**Z-26-149-000**





**LANE**

Z-26-150-330 23 cm, 9"  
Z-26-151-470 33 cm, 13"



**LANE**

Z-26-152-330 23 cm, 9"  
Z-26-153-470 33 cm, 13"



**KERN**

Z-26-154-160 16 cm, 6 1/2" with ratchet  
Z-26-155-210 21 cm, 8 1/2" with ratchet  
Z-26-156-160 16 cm, 6 1/2" without ratchet  
Z-26-157-210 21 cm, 8 1/2" without ratchet



**FARABEU-F-LAMBOTTE**

Z-26-158-230 23 cm, 9" with ratchet  
Z-26-159-260 26 cm, 10 1/4" with ratchet  
Z-26-160-230 23 cm, 9" without ratchet  
Z-26-161-260 26 cm, 10 1/4" without ratchet



**LAMBOTTE**

Z-26-162-265  
26.5 cm, 10 1/2"



**LAMBOTTE**

Z-26-163-220 22 cm, 9"  
Z-26-164-270 27 cm, 10 1/2"  
Z-26-165-330 33 cm, 13"



**HEY GROVES**

Z-26-166-210 21 cm, 8 1/2"  
Z-26-167-270 27 cm, 10 1/2"  
Z-26-168-300 30 cm, 12"



**ULRICH**

Z-26-169-260  
26 cm, 10"

*Knochenfasszange, Repositionszangen  
Pinzas para hueso, Pinzas para reposición*

*Daviers porte-so, Pincés à réduction  
Tenaglie per ossa, Pinze per riposizioni*



**LOWMANN BONE CLAMP**

- Z-26-170-130 18.0 cm, 7"
- Z-26-171-185 20.0 cm, 8"
- Z-26-172-300 22.0 cm, 8 3/4"



**LOWMAN-HOGLUND**

- Z-26-173-175  
17.5 cm, 7"

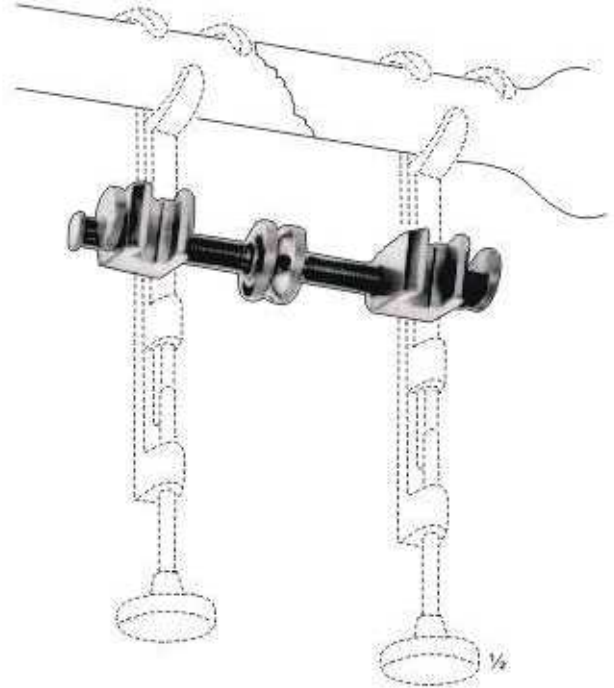

**GERSTER**

- Z-26-174-180 18 cm, 7"
- Z-26-175-200 20 cm, 8"
- Z-26-176-220 22 cm, 9"



**LEWIN**

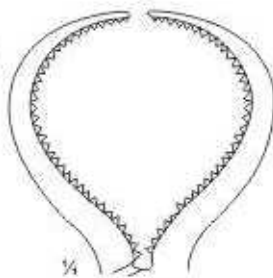

**Z-26-177-175**  
17.5cm, 7"



**ORTHO FORCEPS**

- Z-26-178-130  
13 cm, 5"



**ORTHO FORCEPS**

- Z-26-179-135  
13.5 cm, 5 1/2"  
Angled Serrated



**VERBRUGGE**  
Z-26-180-180  
18 cm, 7"

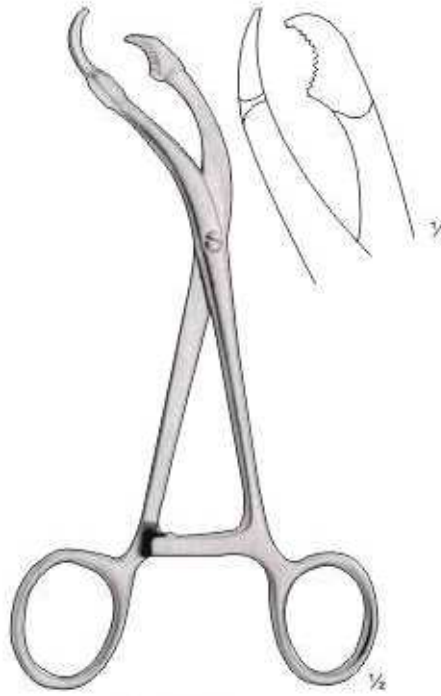

**VERBRUGGE**  
Z-26-181-180  
18 cm, 7"



**VERBRUGGE**  
Z-26-182-250 25 cm, 10"  
Z-26-183-260 26 cm, 10 1/4"  
Z-26-184-270 27 cm, 10 1/2"

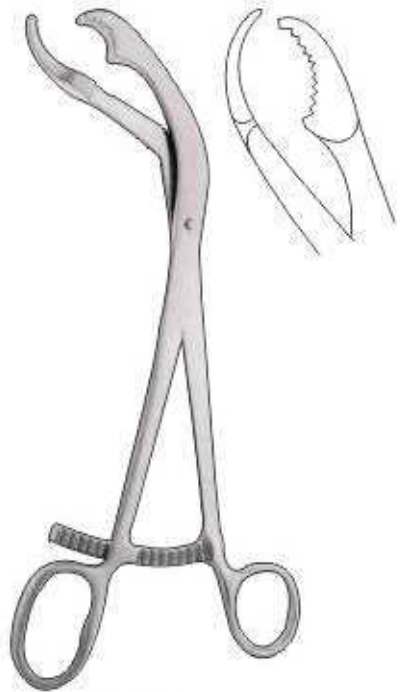

**VERBRUGGE**  
Z-26-185-250 25 cm, 10"  
Z-26-186-260 26 cm, 10 1/4"  
Z-26-187-270 27 cm, 10 1/2"



**VERBRUGGE**  
Z-26-188-180  
18 cm, 7"



**VERBRUGGE**  
Z-26-189-250 25 cm, 10"  
Z-26-190-260 26 cm, 10 1/4"  
Z-26-191-270 27 cm, 10 1/2"

Knochenfasszange, Repositionszangen  
Pinzas para hueso, Pinzas para reposición

Daviers porte-so, Pincas à réduction  
Tenaglie per ossa, Pinze per riposizioni



**REIL**  
Z-26-192-170  
17 cm, 7"

**REDUCTION FORCEPS**  
Z-26-193-200  
20 cm, 8"  
with Points

**Z-26-194-170**  
17 cm, 7"  
For fingers, with drill  
Guide for Kirschner  
Wires up to 1 mm

**HOLDING FORCEPS**  
Z-26-195-130  
13 cm, 5"



**RATCHET FIXATION  
FORCEPS**  
Z-26-196-145  
14.5 cm, 6"

**MALLEOLAR  
FORCEPS**  
Z-26-197-200  
20 cm, 8"

**PATELLA  
FORCEPS**  
Z-26-198-185  
18.5 cm, 7 1/2"

**REDUCTION FORCEPS**  
Z-26-199-160 16 cm, 6 1/2"  
Z-26-200-240 24 cm, 9 1/2"  
with Thread Lock

**REPOSITION  
FORCEPS**  
Z-26-201-230  
23 cm, 9"

**PELVIC REPOSITION FORCEPS**

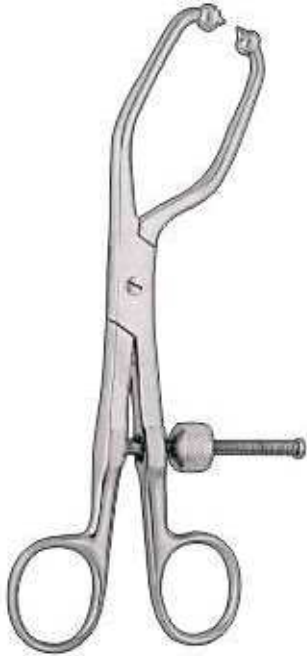

**PELVIC REPOSITION FORCEPS**  
Z-26-202-19  
19 cm, 7 1/2"

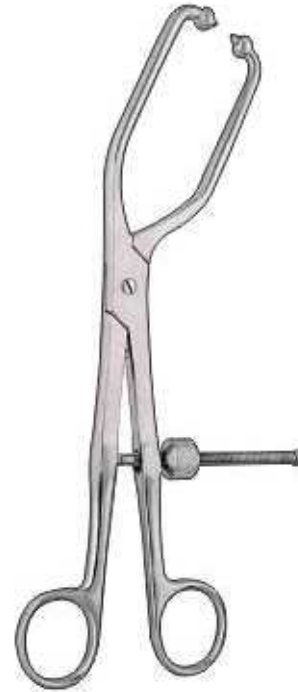

**PELVIC REPOSITION FORCEPS**  
Z-26-203-23  
23 cm, 9"

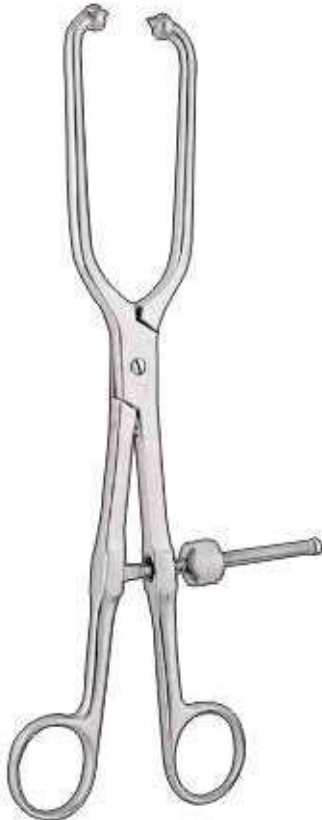

**PELVIC REPOSITION FORCEPS**  
Z-26-204-25  
25 cm, 10"



**PELVIC REPOSITION FORCEPS**  
Z-26-205-25 25 cm, 10"  
3 Balls Spikes

**PELVIC REDUCTION FORCEPS**

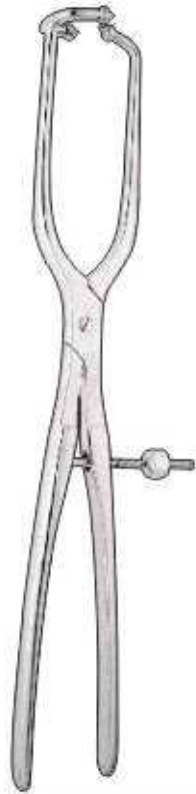

**PELVIC REPOSITION  
FORCEPS**  
Z-26-206-400  
40 cm, 15 3/4"

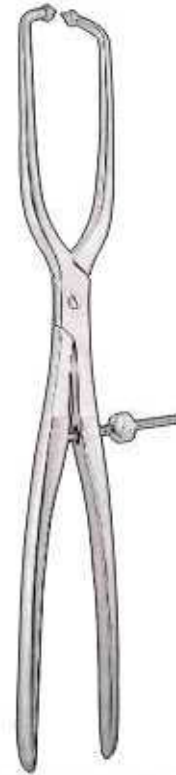

**PELVIC REPOSITION  
FORCEPS**  
Z-26-207-400  
40 cm, 15 3/4"



**PELVIC REDUCTION  
FORCEPS ASYMMETRIC**  
Z-26-208-250  
25 cm, 10"  
with 3 ball Spikes



**PELVIC REDUCTION  
FORCEPS ASYMMETRIC**  
Z-26-209-250  
25 cm, 10"



**PELVIC REDUCTION  
FORCEPS ASYMMETRIC**  
Z-26-210-400  
40 cm, 15 3/4"

**PELVIC INSTRUMENTS**



**SHARP BONE HOOK**  
Z-26-211-04



**TAP HANDLE**  
Z-26-212-01  
for Jacobs Chuck



**PELVIC REPOSITION FORCEPS**  
19 cm, 7 1/2"  
Z-26-213-35 3,5 mm for Screws  
Z-26-214-45 4,5 mm for Screws



**GIGLI SAW**

Z-26-215-030 30 mm  
Z-26-216-040 40 mm  
Z-26-217-050 50 mm  
Z-26-218-070 70 mm  
stainless



**GIGLI HANDLE**  
Z-26-219-000



**ENGEL  
PLASTER SAW**  
Z-26-220-155  
15.5 cm, 6"



**CHARRIERE**  
Z-26-221-250 25 cm, 10"  
Z-26-222-270 27 cm, 10 3/4"  
Double saw



**CHARRIERE**

Z-26-223-270 27 cm, 10 3/4"  
Z-26-224-300 30 cm, 12"



**CHARRIERE**

Z-26-225-350  
35 cm, 13 3/4"



**SATTERLEE**

Z-26-226-310  
31cm, 12 1/4"



**PERCY RETRACTOR**

Z-26-227-000





plane (nylon)  
convex (steel)  
plastic handle  
Head 30mm Ø  
Weight 675 Gr.

**MALLET**  
Z-26-228-265  
26 cm, 10 1/2"



plastic handle  
Head 42 / 30mm Ø  
Weight 530 Gr.

**MALLET**  
Z-26-229-260  
26 cm, 10 1/4"



plastic handle  
Head 30mm Ø  
Weight 480 Gr.

**MALLET**  
Z-26-230-240  
24 cm, 9 1/2"



Plastic Handle  
Head 30mm Ø  
Weight 510 Gr.

**MALLET**  
Z-26-231-260  
26 cm, 10 1/4"



Spare Facing (pair)  
P109-448-00  
Plastic

disks and plastic handle  
Head 37mm Ø  
Weight 370 Gr.

**MALLET**  
Z-26-232-240  
22.5 cm, 9"



made of plastic  
Head 30mm Ø  
Weight 125 Gr.

**MALLET**  
Z-26-233-220  
18 cm, 7"



made of plastic  
with lead filling  
Head 42mm Ø  
Weight 400 Gr.  
Head 42mm Ø  
Weight 250 Gr.

**MALLET**  
Z-26-234-260  
26 cm, 10 1/4"



made of plastic  
with lead filling  
Head 42mm Ø  
Weight 250 Gr.

**MALLET**  
Z-26-235-260  
26 cm, 10 1/4"





**ORTHO / WITH PLASTIC CAPS**  
Z-26-254-180  
18 cm, 7"  
25 mm Dia.  
(140g)  
Pair of spare disks  
with interchangeable  
plastic disks



**ORTHO**  
Z-26-255-265  
26.5 cm, 10 1/2"  
(450g)



**ORTHOPAEDIC  
Z-MALLET**  
Z-26-256-190  
19 cm, 7 1/2"



**HAJEK**  
Z-26-257-223  
22 cm, 8 1/4"  
27 mm Dia.  
(140g)



**ORTHO**  
Z-26-258-265  
26.5 cm  
(450g)



**BERGMANN**  
Z-26-259-240  
24 cm, 9 1/2"  
(300g)



**GERZOG**  
Z-26-260-180  
18 cm, 7"  
(240g)



**OMBREDANNE**  
Z-26-261-240  
24 cm, 9 1/2"  
40 mm dia (550g)













**COTTLE**  
Z-26-262-190  
19 cm, 7 1/2"  
(240g)



**COLLIN**  
Z-26-263-200  
20 cm, 8"  
30 mm dia  
220 g













**BRUNS**

	
<b>Z-26-264-170</b> 17 cm, 7" 000	<b>Z-26-265-170</b> 17 cm, 7" 00
	
<b>Z-26-266-170</b> 17 cm, 7" 0	<b>Z-26-267-170</b> 17 cm, 7" 1
	
<b>Z-26-268-170</b> 17 cm, 7" 2	<b>Z-26-269-170</b> 17 cm, 7" 3
	
<b>Z-26-270-170</b> 17 cm, 7" 4	<b>Z-26-271-170</b> 17 cm, 7" 5
	
<b>Z-26-272-170</b> 17 cm, 7" 6	













**HIBBS-SPRATT / ANGLED**

	
<b>Z-26-273-225</b> 22.5 cm, 9" 000	<b>Z-26-274-225</b> 22.5 cm, 9" 00
	
<b>Z-26-275-225</b> 22.5 cm, 9" 0	<b>Z-26-276-225</b> 22.5 cm, 9" 1
	
<b>Z-26-277-225</b> 22.5 cm, 9" 2	<b>Z-26-278-225</b> 22.5 cm, 9" 3
	
<b>Z-26-279-225</b> 22.5 cm, 9" 4	<b>Z-26-280-225</b> 22.5 cm, 9" 5
	
<b>Z-26-281-225</b> 22.5 cm, 9" 6	



**HIBBS-SPRATT / STRAIGHT**













	
<b>Z-26-282-225</b> 22.5 cm, 9" 000	<b>Z-26-283-225</b> 22.5 cm, 9" 00
	
<b>Z-26-284-225</b> 22.5 cm, 9" 0	<b>Z-26-285-225</b> 22.5 cm, 9" 1
	
<b>Z-26-286-225</b> 22.5 cm, 9" 2	<b>Z-26-287-225</b> 22.5 cm, 9" 3
	
<b>Z-26-288-225</b> 22.5 cm, 9" 4	<b>Z-26-289-225</b> 22.5 cm, 9" 5
	
<b>Z-26-290-225</b> 22.5 cm, 9" 6	



**WILLIGER**  
**Z-26-291-133**  
13.25 cm, 5 1/2"  
Double Ended  
00/0















**SPRATT / HOLLOW HANDLE**

		
<b>Z-26-292-170</b> 17 cm, 7" 00000	<b>Z-26-293-170</b> 17 cm, 7" 0000	<b>Z-26-294-170</b> 17 cm, 7" 000
		
<b>Z-26-295-170</b> 17 cm, 7" 00	<b>Z-26-296-170</b> 17 cm, 7" 0	<b>Z-26-297-170</b> 17 cm, 7" 1
		
<b>Z-26-298-170</b> 17 cm, 7" 2	<b>Z-26-299-170</b> 17 cm, 7" 3	<b>Z-26-300-170</b> 17 cm, 7" 4
		
<b>Z-26-301-170</b> 17 cm, 7" 5		









**VOLKMANN**

		
<b>Z-26-302-170</b> 17 cm, 7" 0000	<b>Z-26-303-170</b> 17 cm, 7" 000	<b>Z-26-304-170</b> 17 cm, 7" 00
		
<b>Z-26-305-170</b> 17 cm, 7" 0	<b>Z-26-306-170</b> 17 cm, 7" 1	<b>Z-26-307-170</b> 17 cm, 7" 2
		
<b>Z-26-308-170</b> 17 cm, 7" 3	<b>Z-26-309-170</b> 17 cm, 7" 4	<b>Z-26-310-170</b> 17 cm, 7" 5
		
<b>Z-26-311-170</b> 17 cm, 7" 6		



**VOLKMANN**

	
<b>Z-26-312-130</b> 13 cm, 5" Double Ended 6.2 mm & 6.7 mm	
	
<b>Z-26-313-160</b> 16 cm, 6 1/2" Double Ended 7 mm & 9 mm	
	
<b>Z-26-314-200</b> 20 cm, 8" Double Ended 9.1 mm & 11.1 mm	



3.6 mm  
Z-26-315-36

4.4 mm  
Z-26-316-44

5.2 mm  
Z-26-317-52

6.0 mm  
Z-26-318-60

Z-26-315-36 To  
Z-26-318-60  
25 cm, 10"



**UFFENORDE Left**  
Z-26-319-175  
17.5 cm, 7"



**UFFENORDE Right**  
Z-26-320-175  
17.5 cm, 7"



**SIMON**  
24 cm, 9 1/2"

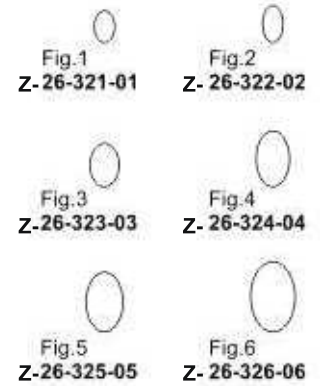

**BRUNS**  
23 mm, 9"

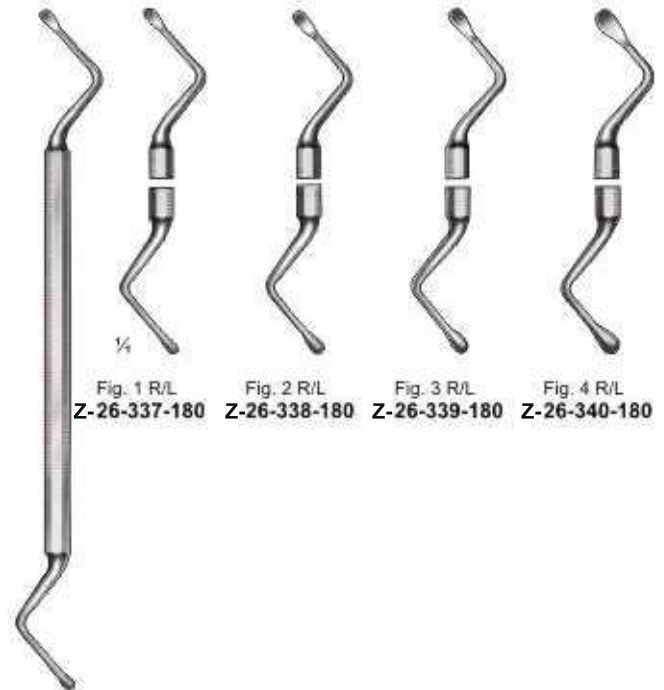
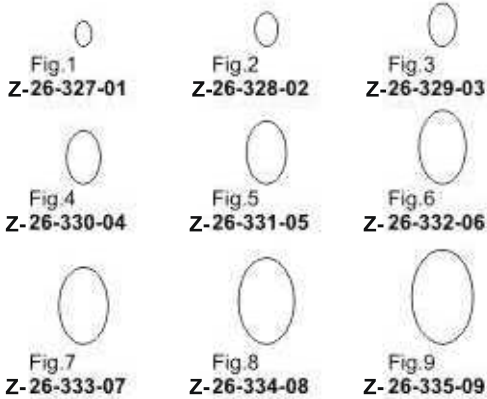

**LUCAS**  
double-ended  
Z-26-336-180  
18 cm, 7"

**BONE CURETTES, DOUBLE-ENDED**

Scharfe Doppellöffel  
Cucharillas de doble extremo

Curettes doubles  
Curette doppie



Z-26-341-01

Z-26-342-02

Z-26-343-03

**WILLIGER**  
13.5 cm, 5 1/4"



Z-26-344-01

Z-26-345-02

Z-26-346-03

**MARTINI**  
13.5 cm, 5 1/4"



**JANSEN**  
Z-26-347-16  
16 cm, 6 1/4"



**JANSEN**  
Z-26-348-16  
15 cm, 6"



Z-26-349-21  
21 cm, 8 1/4"



Z-26-350-130  
13 cm, 5 1/4"

Z-26-351-140  
14 cm, 5 1/4"

Z-26-352-170  
17 cm, 6 3/4"

**VOLKMANN**



**VOLKMANN**

Z-26-353-130  
13 cm, 5 1/4"

Z-26-354-160  
16 cm, 6 1/4"

Z-26-355-200  
20 cm, 8"



- Fig. 0000 Z-26-356-40
- Fig. 000 Z-26-357-30
- Fig. 00 Z-26-358-20
- Fig. 0 Z-26-359-10
- Fig. 1 Z-26-360-01
- Fig. 2 Z-26-361-02
- Fig. 3 Z-26-362-03
- Fig. 4 Z-26-363-04
- Fig. 5 Z-26-364-05



- Fig. 0000 Z-26-365-40
- Fig. 000 Z-26-366-30
- Fig. 00 Z-26-367-20
- Fig. 0 Z-26-368-10
- Fig. 1 Z-26-369-01
- Fig. 2 Z-26-370-02
- Fig. 3 Z-26-371-03
- Fig. 4 Z-26-372-04
- Fig. 5 Z-26-373-05
- Fig. 6 Z-26-374-06



- Z-26-375-000 Straight
- Z-26-376-03 Down Angle
- Z-26-377-04 Up Angle

**SPRATT**

**BRUNS**

**SCOVILLE**  
25 cm, 10"



- Fig. 0 Z-26-378-10
- Fig. 1 Z-26-379-01
- Fig. 2 Z-26-380-02
- Fig. 3 Z-26-381-03



- BRUNS**  
27 cm, 10 3/4" straight
- Z-26-382-40 Fig. 0000
  - Z-26-383-30 Fig. 000
  - Z-26-384-20 Fig. 00
  - Z-26-385-10 Fig. 0
  - Z-26-386-01 Fig. 1
  - Z-26-387-02 Fig. 2
  - Z-26-388-03 Fig. 3
  - Z-26-389-04 Fig. 4
  - Z-26-390-05 Fig. 5
  - Z-26-391-06 Fig. 6



- BRUNS**  
27 cm, 10 3/4" angled
- Z-26-392-40 Fig. 0000
  - Z-26-393-30 Fig. 000
  - Z-26-394-20 Fig. 00
  - Z-26-395-10 Fig. 0
  - Z-26-396-01 Fig. 1
  - Z-26-397-02 Fig. 2
  - Z-26-398-03 Fig. 3
  - Z-26-399-04 Fig. 4
  - Z-26-400-05 Fig. 5
  - Z-26-401-06 Fig. 6



- Z-26-402-000 4 mm x 10 mm straight
- Z-26-403-004 4 mm x 10 mm up angle
- Z-26-404-003 4 mm x 10 mm down angle

**FIBER HANDLE**  
27 cm, 10 3/4"

**SCOVILLE**  
25 cm, 10"  
Ruptured Disc Curette



Z-26-405-05  
5 mm

Z-26-406-07  
7 mm

Z-26-407-09  
9 mm

Z-26-408-10  
10 mm

Z-26-409-10  
12 mm

**CUSHING**  
23.5 cm, 9 1/4"  
Pituitary Spoon,  
malleable, silver-plated



Fig.1  
Z-26-410-01

Fig.4  
Z-26-411-04

Fig.2  
Z-26-412-02

Fig.5  
Z-26-413-05

Fig.3  
Z-26-414-03

Fig.6  
Z-26-415-06

**SIMON**  
24 cm, 9 1/2"



Ray, 190 mm  
Pituitary Curette



45°  
Z-26-416-03 Ø 3 mm  
Z-26-417-04 Ø 4 mm  
Z-26-418-05 Ø 5 mm



90°  
Z-26-419-03 Ø 3 mm  
Z-26-420-04 Ø 4 mm  
Z-26-421-05 Ø 5 mm



45° offset  
Z-26-422-03 Ø 3 mm  
Z-26-423-04 Ø 4 mm  
Z-26-424-05 Ø 5 mm



90° offset  
Z-26-425-03 Ø 3 mm  
Z-26-426-04 Ø 4 mm  
Z-26-427-05 Ø 5 mm



**TAY-BRONSON**  
22 cm, 8 3/4"  
Pituitary Curette, double-edged



Z-26-428-04 Ø 4 mm  
straight



30°  
Z-26-429-03 Ø 3 mm  
Z-26-430-04 Ø 4 mm  
Z-26-431-05 Ø 5 mm



45°  
Z-26-432-03 Ø 3 mm  
Z-26-433-04 Ø 4 mm  
Z-26-434-04 Ø 5 mm



**IMPACTORS / TAMPS**

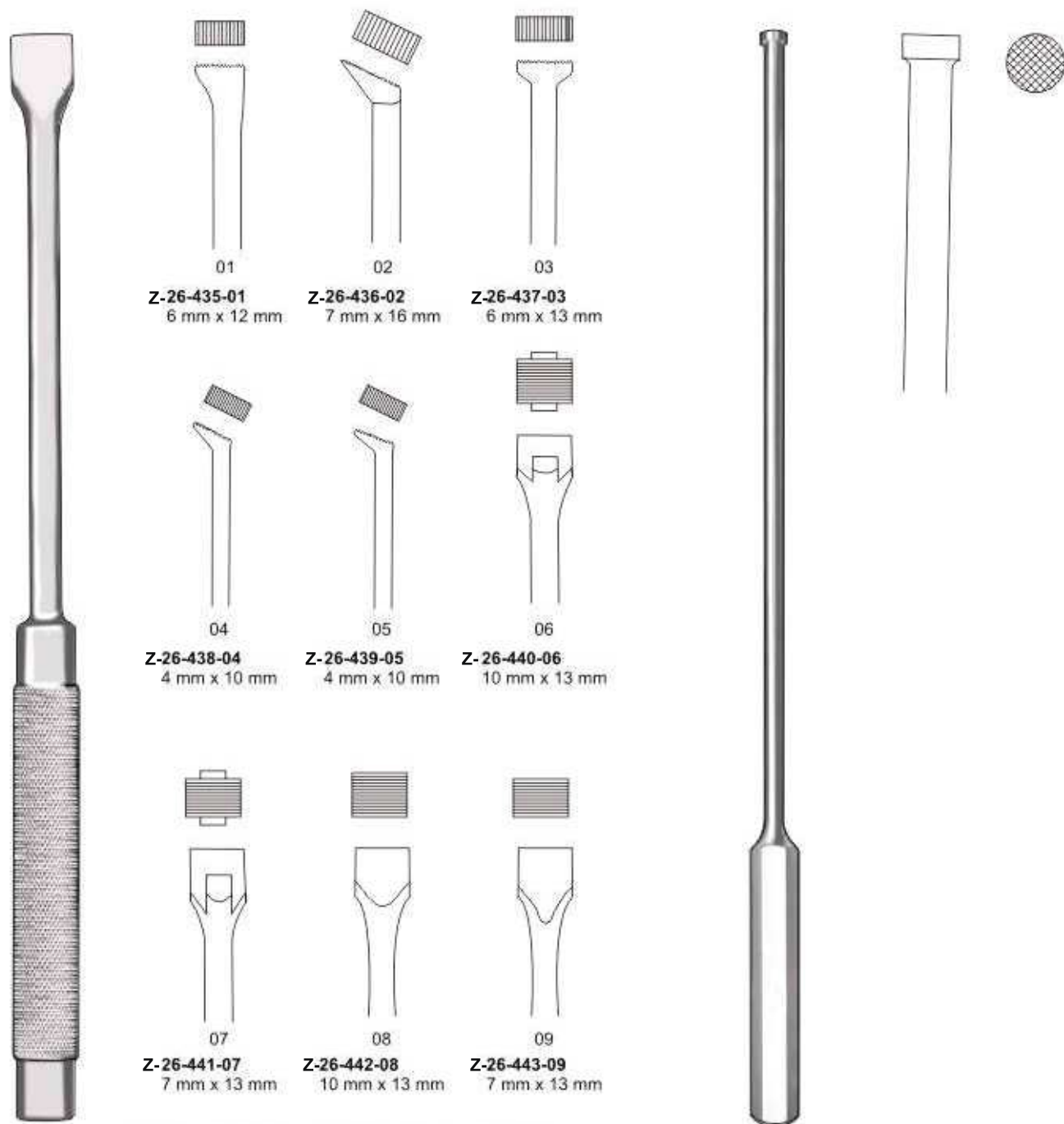

**LUMBAR, CERVICAL IMPACTORS & DRIVERS**

	serrated tips	
<b>Z-26-435-01</b>	Impactor, standard offset,	21.5 cm, 8 ¼"
<b>Z-26-436-02</b>	Impactor, central canal,	21.5 cm, 8 ¼"
<b>Z-26-437-03</b>	Impactor, lateral narrow,	21.5 cm, 8 ¼"
<b>Z-26-438-04</b>	Impactor, micro offset,	18.0 cm, 7"
<b>Z-26-439-05</b>	Impactor, micro lateral,	18.0 cm, 7"
<b>Z-26-440-06</b>	Graft Driver, lumbar, guarded,	21.5 cm, 8 ¼"
<b>Z-26-441-07</b>	Graft Driver, anterior, guarded,	21.5 cm, 8 ¼"
<b>Z-26-442-08</b>	Graft Driver, lumbar, unguarded,	21.5 cm, 8 ¼"
<b>Z-26-443-09</b>	Graft Driver, anterior, unguarded,	21.5 cm, 8 ¼"

**BONE TAMP ENDOSCOPIC**

<b>Z-26-444-10</b>	43 cm, 17"
	10 mm diameter

Knochenmeißel, Osteotome  
Cinceles, Osteótomos

Ciseaux-burins, Ostéotomes  
ScalPELLi, Osteotomi

**HIBBS CHISEL**

22.5 cm, 9", straight		22.5 cm, 9", curved	
Z-26-445-06	6 mm	Z-26-455-06	6 mm
Z-26-446-09	9 mm	Z-26-456-09	9 mm
Z-26-447-12	12 mm	Z-26-457-12	12 mm
Z-26-448-15	15 mm	Z-26-458-15	15 mm
Z-26-449-18	18 mm	Z-26-459-18	18 mm
Z-26-450-20	20 mm	Z-26-461-20	20 mm
Z-26-451-25	25 mm	Z-26-462-25	25 mm
Z-26-452-30	30 mm	Z-26-463-30	30 mm
Z-26-453-35	35 mm	Z-26-464-35	35 mm
Z-26-454-40	40 mm	Z-26-465-40	40 mm

**OSTEOTOMES**

22.5 cm, 9", straight		22.5 cm, 9", curved	
Z-26-466-06	6 mm	Z-26-476-06	6 mm
Z-26-467-09	9 mm	Z-26-477-09	9 mm
Z-26-468-12	12 mm	Z-26-478-12	12 mm
Z-26-469-15	15 mm	Z-26-479-15	15 mm
Z-26-470-18	18 mm	Z-26-480-18	18 mm
Z-26-471-20	20 mm	Z-26-481-20	20 mm
Z-26-472-25	25 mm	Z-26-482-25	25 mm
Z-26-473-30	30 mm	Z-26-483-30	30 mm
Z-26-474-35	35 mm	Z-26-484-35	35 mm
Z-26-475-40	40 mm	Z-26-485-40	40 mm

HIBBS CHISEL / OSTEOTOMES

**COBB CHISEL**

27.5 cm, 10 3/4", straight		27.5 cm, 10 3/4", curved	
Z-26-486-06	6 mm	Z-26-493-06	6 mm
Z-26-487-09	9 mm	Z-26-494-09	9 mm
Z-26-488-12	12 mm	Z-26-495-12	12 mm
Z-26-489-15	15 mm	Z-26-496-15	15 mm
Z-26-490-18	18 mm	Z-26-497-18	18 mm
Z-26-491-25	25 mm	Z-26-498-25	25 mm
Z-26-492-35	35 mm	Z-26-499-35	35 mm

**OSTEOTOMES**

275 mm straight		275 mm curved	
Z-26-500-06	6 mm	Z-26-507-06	6 mm
Z-26-501-09	9 mm	Z-26-508-09	9 mm
Z-26-502-12	12 mm	Z-26-509-12	12 mm
Z-26-503-15	15 mm	Z-26-510-15	15 mm
Z-26-504-18	18 mm	Z-26-511-18	18 mm
Z-26-505-25	25 mm	Z-26-512-25	25 mm
Z-26-506-35	35 mm	Z-26-513-35	35 mm

COBB CHISEL / OSTEOTOMES

**HIBBS CHISEL endoscopic**

Z-26-514-10  
46 cm, 18"  
10 mm tip width straight

**HIBBS OSTEOTOMES endoscopic**

Z-26-515-10  
46 cm, 18"  
10 mm tip width straight



**HARRINGTON**  
Spinal Elevator  
**Z-26-516-19** 30 cm, 12"  
Sharp 19 mm tip width



**RIB ELEVATOR**, 42.5 cm, 16 3/4"  
endoscopic, Sharp with fiber  
handle 9 mm radius tip  
**Z-26-517-45** angled 45°  
**Z-26-518-90** angled 90°

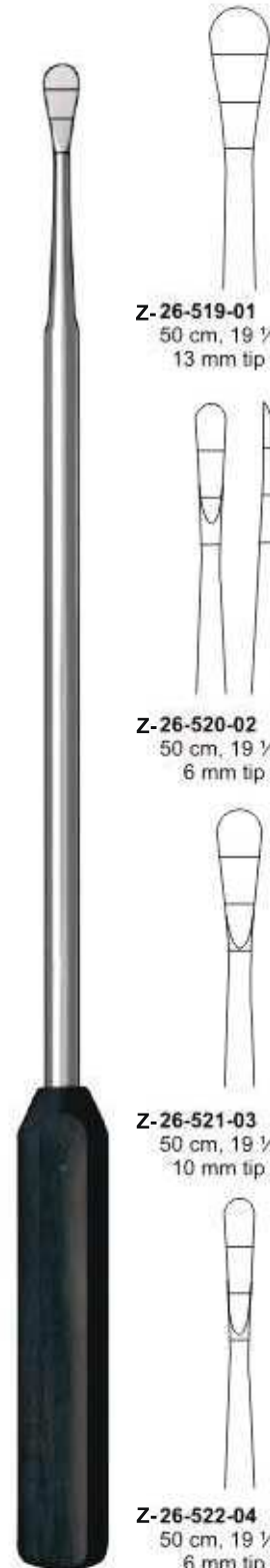

**Z-26-519-01**  
50 cm, 19 1/2" sharp  
13 mm tip width

**Z-26-520-02**  
50 cm, 19 1/2" sharp  
6 mm tip width

**Z-26-521-03**  
50 cm, 19 1/2" sharp  
10 mm tip width

**Z-26-522-04**  
50 cm, 19 1/2" sharp  
6 mm tip width

**COBB SPINAL**  
Elevator endoscopic  
with fiber handle  
graduated tips



Z-26-523-01  
Z-26-524-02  
Z-26-525-03



Z-26-526-04



Z-26-527-05



Z-26-528-06  
Z-26-529-07  
Z-26-530-08



Z-26-531-09



Z-26-532-10



Z-26-533-11



Z-26-534-12



Z-26-535-13  
Z-26-536-14



Z-26-537-15



Z-26-538-16  
Z-26-539-17



Z-26-540-18  
Z-26-541-19

**RHOTON MICRO** Dissection Instruments 19 cm, 7 1/2"

- Z-26-523-01 Round Dissector 1 mm, angled
- Z-26-524-02 Round Dissector 2 mm, angled
- Z-26-525-03 Round Dissector 3 mm, angled
- Z-26-526-04 Elevator, curved
- Z-26-527-05 Elevator, angled
- Z-26-528-06 Spatula Dissector # 6 small, angled
- Z-26-529-07 Spatula Dissector # 7 medium, angled
- Z-26-530-08 Spatula Dissector # 8 large, angled
- Z-26-531-09 Hook, 90 angle, sharp
- Z-26-532-10 Hook, 90 angle, blunt
- Z-26-533-11 Hook, 45 angle, sharp
- Z-26-534-12 Needle, straight, sharp
- Z-26-535-13 Micro Curette, straight, 1 mm x 2 mm
- Z-26-536-14 Micro Curette, angled, 1 mm x 2 mm
- Z-26-537-15 Ball-tipped Dissector, 0.8 mm
- Z-26-538-16 Ball-tipped Dissector, 90 angle, 3 mm
- Z-26-539-17 Ball-tipped Dissector, 90 angle, 5 mm
- Z-26-540-18 Ball-tipped Dissector, 40 angle, 4 mm
- Z-26-541-19 Ball-tipped Dissector, 40 angle, 8 mm



**SMITHWICK HOOK & DISSECTOR**  
**Z-26-542-300**  
30 cm, 12" double ended  
5 mm semi-sharp end  
and 1 x 10 mm blunt hook



**Z-26-543-45**  
angled 45°



**Z-26-544-90**  
angled 90°



**NERVE PROBE ENDOSCOPIC**  
38 cm, 15"  
with ball end 80 mm tip &  
shaft length 29 cm, 11 1/2"  
handle length 7.1 mm  
shaft diameter



**PENFIELD ELEVATOR ENDOSCOPIC**  
**Z-26-545-380**  
38 cm, 15"  
blunt, 4 mm tip width  
88 mm tip and shaft length, graduated  
29 cm, 11 1/2" handle length  
7.1 mm shaft diameter



**SACHS NERVE**  
Z-26-546-185  
18.5 cm, 7 1/4"  
3 mm blunt



**KLEINERT KUTZ**  
Elevator and Dissector  
Z-26-547-195  
19.5 cm, 7 3/4"  
2 mm x 3 mm Sharp ends



**FREER Elevator**  
Z-26-548-185  
18.5 cm, 7 1/4"  
double ended  
5 mm sharp end  
5 mm blunt end



**WOODSON**  
Elevator/Spatula  
Z-26-549-225  
22.5 cm, 9"  
double ended  
3 mm semi-blunt ends



**WOODSON DURAL**  
Separator/Packer  
Z-26-550-175  
17.5 cm, 7"  
double ended with grooved  
blade 3 mm blunt end

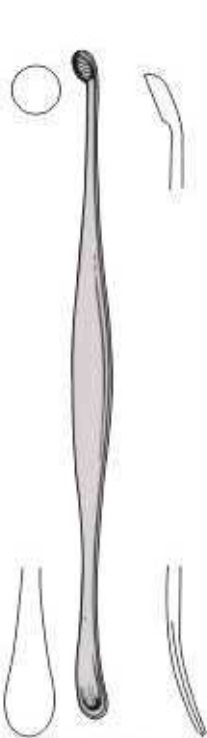

**Z-26-551-175**  
style #1  
17.5 cm, 7"  
double ended

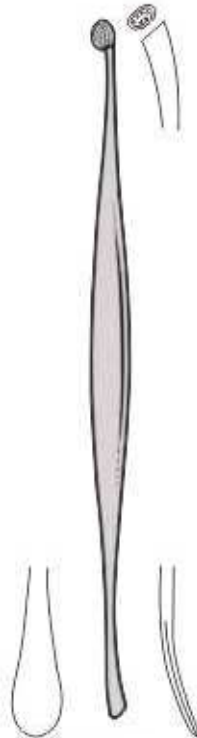

**Z-26-552-185**  
style #2  
18.5 cm, 7 1/4"  
double ended

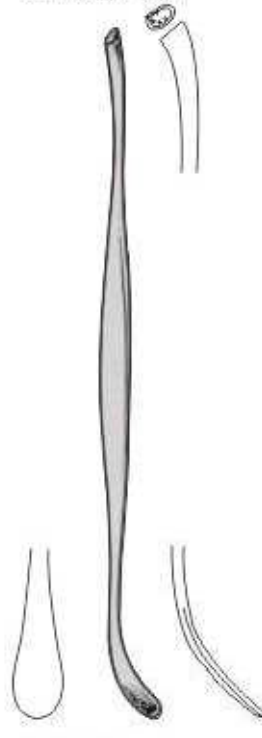

**PENFIELD Elevators**  
style #3  
Z-26-553-280  
28 cm, 11"  
double ended



**Z-26-554-280**  
style #4  
28 cm, 11"  
single ended

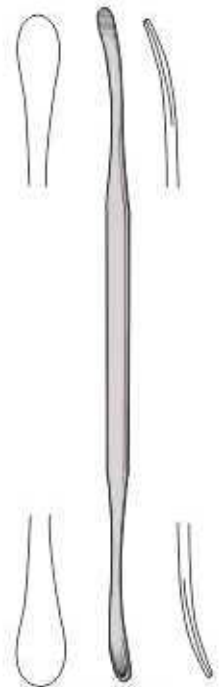

**Z-26-555-185**  
style #5  
18.5 cm, 7 1/4"  
double ended

# REAMER, ELEVATORS, BONE FILES & ALVEOTOMY FILES

Reibahlen, Elevatoren, Knochenfeilen, Alveotomiefeilen

Pointes-carrées, Elevateurs, Limes à os, Limes pour alvéolotomie

Escariadores, Elevadores, Limas para huesos, Limas para alveolotomia

Punteruoli, Elevatori, Lime per ossa, Lime per alveolotomia



**Z-26-556-140**  
14 cm, 5 1/2"

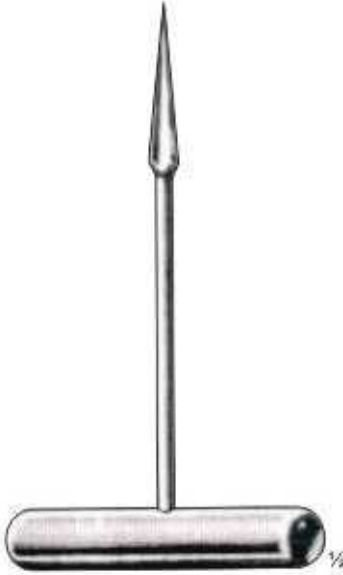

**Z-26-557-140**  
14 cm, 5 1/2"



**PERTHES**  
Z-26-558-160 16 cm, 6 1/2"  
Z-26-559-220 22 cm, 8 3/4"



**BONE HOOK**  
Z-26-560-230  
23 cm, 9"  
3 cm Dia.



**PUTTI**  
Z-26-561-280 27 cm, 10 1/2"



**PUTTI**  
Z-26-562-300 30 cm, 12"



**BONE TAMP**  
Z-26-563-154  
15.4 cm, 6"

Tip Size  
2 mm  
3 mm  
4 mm  
5 mm  
6 mm  
8 mm  
10 mm



**FOMAN RASP**  
Z-26-564-210  
21 cm, 8 1/2"



**MILLER-COLBURN BONE FILE**  
Z-26-565-180  
18 cm, 7"

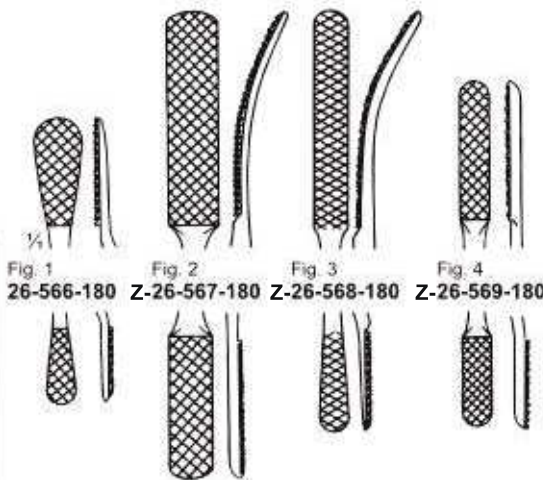
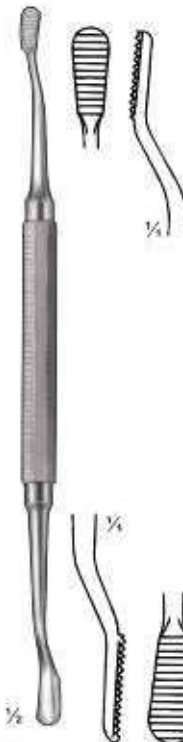
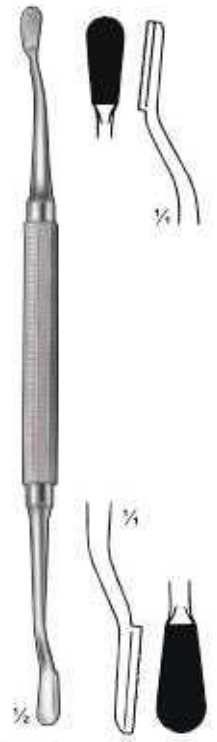

Fig. 1 26-566-180  
Fig. 2 Z-26-567-180  
Fig. 3 Z-26-568-180  
Fig. 4 Z-26-569-180



**MILLER ALVEOTOMY FILE**  
Z-26-570-190  
19 cm, 7 1/2"



**MILLER ALVEOTOMY FILE**  
Z-26-571-190  
19 cm, 7 1/2"



**COBB**  
24 cm, 9 1/4"



**COBB**  
24 cm, 9 1/4"



**Z-26-572-01**  
Straight



**Z-26-574-03**  
Strongly Curved



**Z-26-576-05**  
Straight



**Z-26-578-07**  
Strongly Curved



**Z-26-573-02**  
Slightly Curved



**Z-26-575-04**  
Curved down



**Z-26-577-06**  
Slightly Curved



**Z-26-579-08**  
Curved down



**HIBBS GOUGS** endoscopic.  
**Z-26-580-460** 46 cm, 18"  
7 mm tip width straight, graduated





**LEXER Osteotome**

- 22 cm, 8 3/4"  
 26-581-07 7 mm  
 26-582-10 10 mm  
 26-583-12 12 mm  
 26-584-15 15 mm  
 26-585-20 20 mm  
 26-586-25 25 mm  
 26-587-30 30 mm

**LEXER modif. Osteotome**

- 29 cm, 11 1/2"  
 26-588-07 7 mm  
 26-589-10 10 mm  
 26-590-12 12 mm  
 26-591-15 15 mm  
 26-592-20 20 mm  
 26-593-25 25 mm  
 26-594-30 30 mm



**LEXER modif. Gouge**

- 29 cm, 11 1/2"  
 Z-26-595-07 7 mm  
 Z-26-596-10 10 mm  
 Z-26-597-12 12 mm  
 Z-26-598-15 15 mm  
 Z-26-599-20 20 mm  
 Z-26-600-25 25 mm  
 Z-26-601-30 30 mm

**LEXER Gouge**

- 22 cm, 8 3/4"  
 Z-26-602-07 7 mm  
 Z-26-603-10 10 mm  
 Z-26-604-12 12 mm  
 Z-26-605-15 15 mm  
 Z-26-606-20 20 mm  
 Z-26-607-25 25 mm  
 Z-26-608-30 30 mm



**LEXER**

- 25 mm, 10"  
 Z-26-609-07 7 mm  
 Z-26-610-10 10 mm  
 Z-26-611-15 15 mm  
 Straight



**LEXER**

- 25 mm, 10"  
 Z-26-612-07 7 mm  
 Z-26-613-10 10 mm  
 Z-26-614-15 15 mm  
 Curved



**FLAT**

- Z-26-615-10 10 mm  
 Z-26-616-15 15 mm  
 Z-26-617-20 20 mm  
 Z-26-618-25 25 mm



**HOLLOW**

- Z-26-619-10 10 mm  
 Z-26-620-15 15 mm  
 Z-26-621-20 20 mm  
 Z-26-622-25 25 mm



**MINI LEXER**

- Z-26-623-180  
 18 cm, 7"



**MINI LEXER**

- Z-26-624-180  
 18 cm, 7"  
 Hollow



- Straight
- Z-26-625-200 09 mm
  - Z-26-626-200 14 mm
  - Z-26-627-200 19 mm
  - Z-26-628-200 25 mm
- Curved
- Z-26-629-200 09 mm
  - Z-26-630-200 14 mm
  - Z-26-631-200 19 mm
  - Z-26-632-200 25 mm

**SMITH PETERSON**  
20 cm, 8"

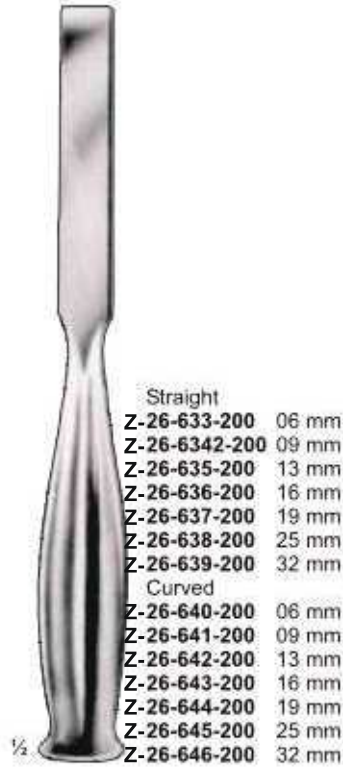

- Straight
- Z-26-633-200 06 mm
  - Z-26-6342-200 09 mm
  - Z-26-635-200 13 mm
  - Z-26-636-200 16 mm
  - Z-26-637-200 19 mm
  - Z-26-638-200 25 mm
  - Z-26-639-200 32 mm
- Curved
- Z-26-640-200 06 mm
  - Z-26-641-200 09 mm
  - Z-26-642-200 13 mm
  - Z-26-643-200 16 mm
  - Z-26-644-200 19 mm
  - Z-26-645-200 25 mm
  - Z-26-646-200 32 mm

**SMITH PETERSON**  
20 cm, 8"



- Straight
- Z-26-647-200 10 mm
  - Z-26-648-200 15 mm
  - Z-26-649-200 20 mm
  - Z-26-650-200 25 mm
- Curved
- Z-26-651-200 10 mm
  - Z-26-652-200 15 mm
  - Z-26-653-200 20 mm
  - Z-26-654-200 25 mm

**STILLE**  
20 cm, 8"

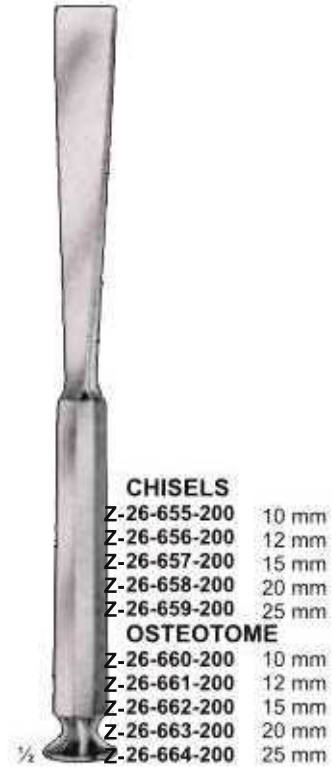

- CHISELS**
- Z-26-655-200 10 mm
  - Z-26-656-200 12 mm
  - Z-26-657-200 15 mm
  - Z-26-658-200 20 mm
  - Z-26-659-200 25 mm
- OSTEOTOME**
- Z-26-660-200 10 mm
  - Z-26-661-200 12 mm
  - Z-26-662-200 15 mm
  - Z-26-663-200 20 mm
  - Z-26-664-200 25 mm

**STILLE**  
20 cm, 8"

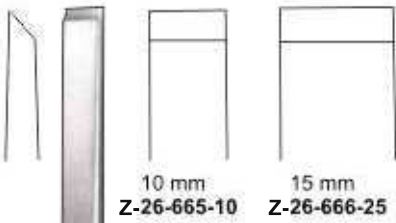

10 mm Z-26-665-10 15 mm Z-26-666-25

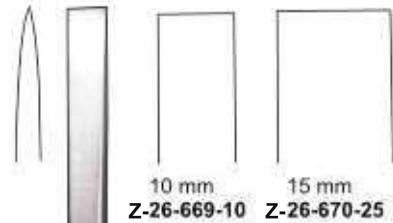

10 mm Z-26-669-10 15 mm Z-26-670-25



20 mm Z-26-667-25



20 mm Z-26-671-25

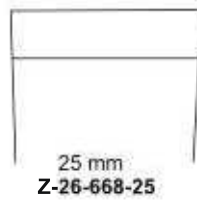

25 mm Z-26-668-25



25 mm Z-26-672-25



- Z-26-674-005 Chisel Blade 0.5 cm
- Z-26-675-010 Chisel Blade 1.0 cm
- Z-26-676-016 Chisel Blade 1.6 cm
- Z-26-677-025 Chisel Blade 2.5 cm

- Z-26-678-005 Osteotome Blade 0.5 cm
- Z-26-679-010 Osteotome Blade 1.0 cm
- Z-26-680-016 Osteotome Blade 1.6 cm
- Z-26-681-025 Osteotome Blade 2.5 cm



**STILLE**  
Z-26-665-10 – 26-668-25  
20 cm, 8"



**Z-26-669-10 – 26-672-25**  
20 cm, 8"



**CHISEL HANDLE**  
Z-26-673-000



**Z-26-682-000**  
Wrench for Chisel Handle

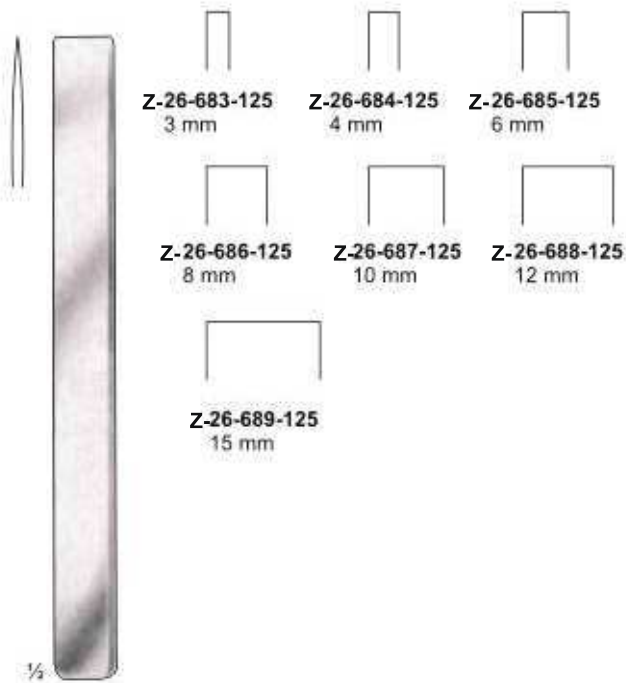

**MINI-LAMBOTTE**  
12.5 cm, 5"

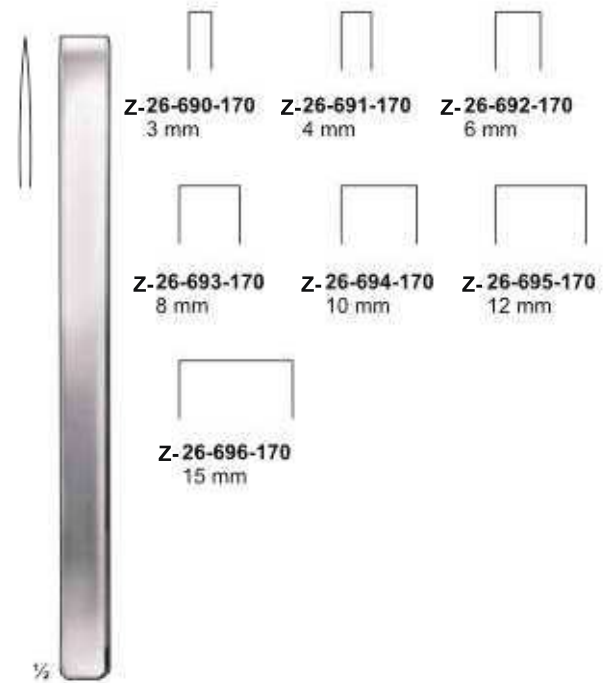

**MINI LAMBOTTE**  
17 cm, 6 3/4"

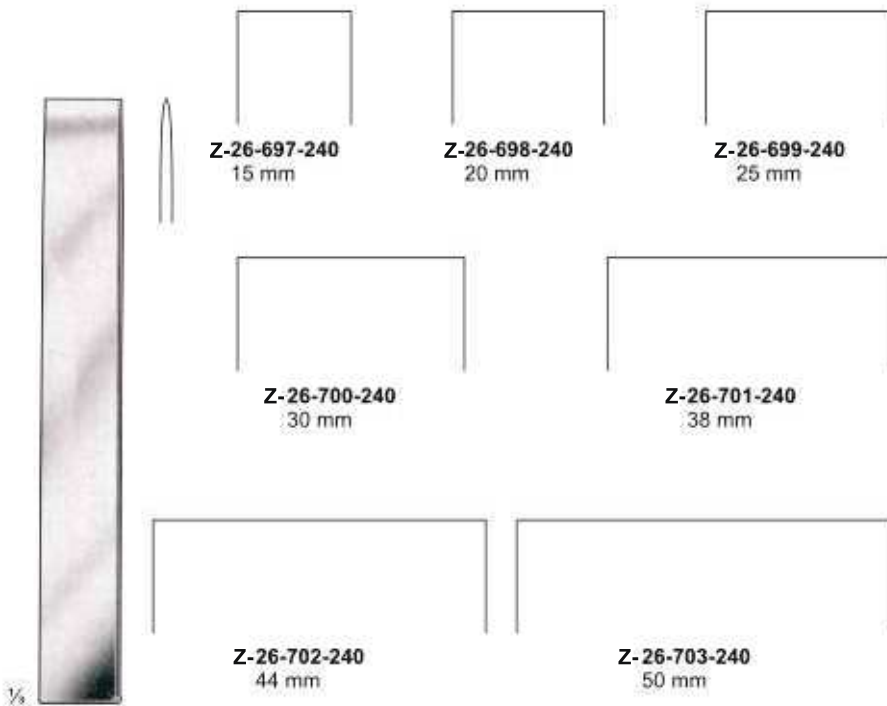

**LAMBOTTE**  
24 cm, 9 1/2"

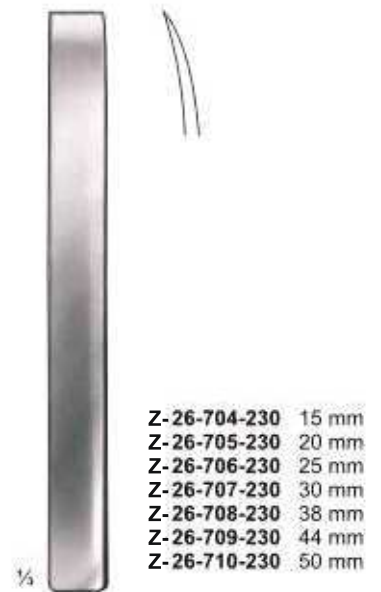

**LAMBOTTE**  
23 cm, 9"

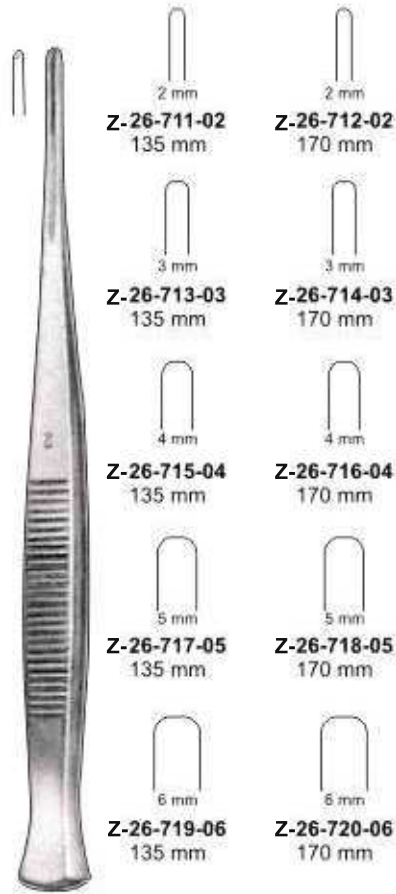

PARTSCH

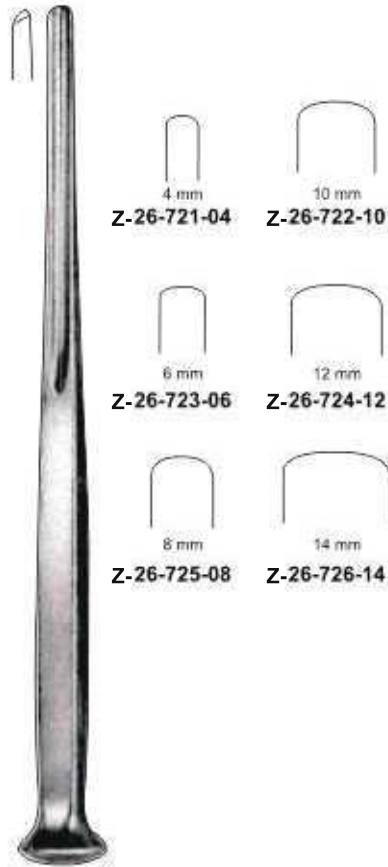

ALEXANDER

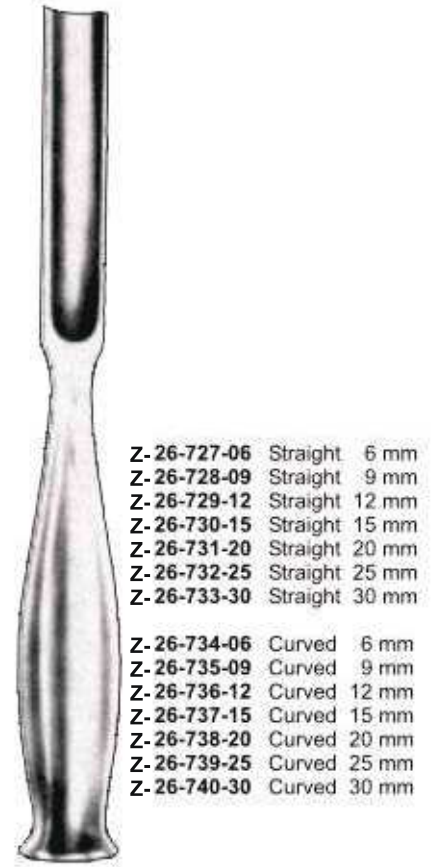

SMITH PETERSON

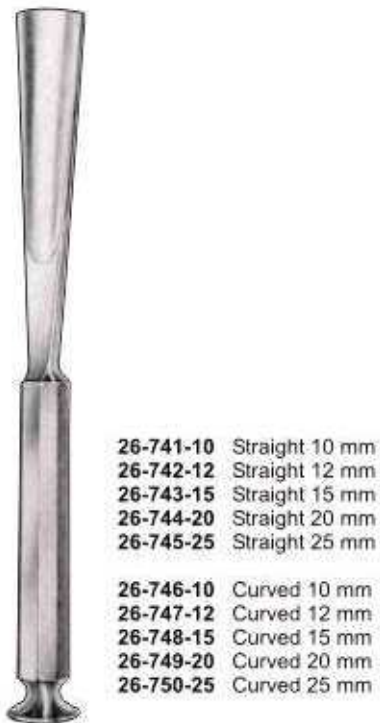

STILLE





**SMITH-PETERSON, 20 cm, 8"**

Osteotome, Straight

Z-26-757-06	6 mm
Z-26-758-09	9 mm
Z-26-759-12	12 mm
Z-26-760-15	15 mm
Z-26-761-20	20 mm
Z-26-762-25	25 mm
Z-26-763-30	30 mm



**SMITH-PETERSON, 20 cm, 8"**

Osteotome, curved

Z-26-764-06	6 mm
Z-26-765-09	9 mm
Z-26-766-12	12 mm
Z-26-767-15	15 mm
Z-26-768-20	20 mm
Z-26-769-25	25 mm
Z-26-770-30	30 mm



**SMITH-PETERSON, 20 cm, 8"**

Gouge, Straight

Z-26-771-06	6 mm
Z-26-772-09	9 mm
Z-26-773-12	12 mm
Z-26-774-15	15 mm
Z-26-775-20	20 mm
Z-26-776-25	25 mm
Z-26-777-30	30 mm



**SMITH-PETERSON, 20 cm, 8"**

Gouge, curved

Z-26-778-06	6 mm
Z-26-779-09	9 mm
Z-26-780-12	12 mm
Z-26-781-15	15 mm
Z-26-782-20	20 mm
Z-26-783-25	25 mm
Z-26-784-30	30 mm



**LAMBOTTE, 24 cm, 9 1/2"**

Osteotome, Straight

Z-26-785-06	6 mm
Z-26-786-09	9 mm
Z-26-787-12	12 mm
Z-26-788-15	15 mm
Z-26-789-20	20 mm
Z-26-790-25	25 mm
Z-26-791-30	30 mm



Z-26-792-12  
12 mm



Z-26-793-19  
19 mm



Z-26-794-25  
25 mm



Z-26-795-32  
32 mm

**COBB SPINAL** Elevator  
23.8 cm, 9 1/2" sharp  
with hexagonal handle



**HARRINGTON SPINAL**  
Elevator  
Z-26-796-19  
30 cm, 12", Sharp  
19 mm tip width



7 mm



9 mm



11 mm

**COBB MODIF.**  
Z-26-797-07 7 mm  
Z-26-798-09 9 mm  
Z-26-799-11 11 mm  
28 cm, 11" Round Handle



4 mm



6 mm



8 mm

**COBB MODIF.**  
Z-26-800-04 4 mm  
Z-26-801-06 6 mm  
Z-26-802-08 8 mm  
28 cm, 11" Round Handle

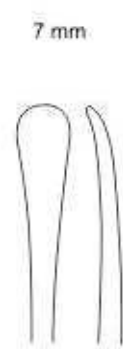

7 mm

Z-26-803-07  
16 cm, 6 1/4"

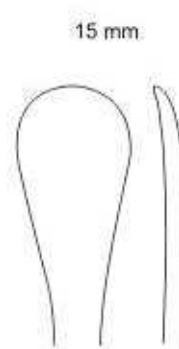

15 mm

Z-26-804-15  
19 cm, 7 1/2"

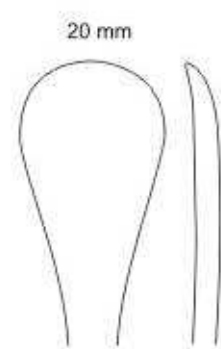

20 mm

Z-26-805-20  
20 cm, 8"

**HOEN**



**SEBILEAU**  
Z-26-806-175  
17.5 cm, 7"



**PERIOSTEAL Elevator**  
**Z-26-807-182**  
18.2 cm, 7"  
Fiber/Phenolic Handle  
blade 6mm



**26-808-190**  
19 cm, 7 1/2" 13 mm  
**26-809-200**  
20 cm, 8" 20 mm  
**26-810-230**  
23 cm, 9" 25 mm  
**26-811-250**  
25 cm, 10" 31 mm

**CHANDLER Bone Elevator**



**HOEN PERIOSTEAL Elevator**  
**Z-26-812-165**  
16.5 cm, 6 1/2"



**KEY PERIOSTEAL Elevator**  
**Z-26-813-180**  
18 cm, 7 1/2"



**KEY (Fig. A)**

Fig.	Item	Description	Inch.	Width
A	<b>26-814-190</b>	19 cm	7 1/2"	3 mm
A	<b>26-815-190</b>	19 cm	7 1/2"	6 mm
A	<b>26-816-190</b>	19 cm	7 1/2"	9 mm
A	<b>26-817-190</b>	19 cm	7 1/2"	12 mm
A	<b>26-818-190</b>	19 cm	7 1/2"	15 mm
A	<b>26-819-190</b>	19 cm	7 1/2"	19 mm
A	<b>26-820-190</b>	19 cm	7 1/2"	25 mm



**COBB Elevators**  
**Z-26-821-234**  
23.4 cm, 9"  
Hex Handle



**PERIOSTEAL ELEVATOR**  
**Z-26-822-170**  
17 cm, 7"

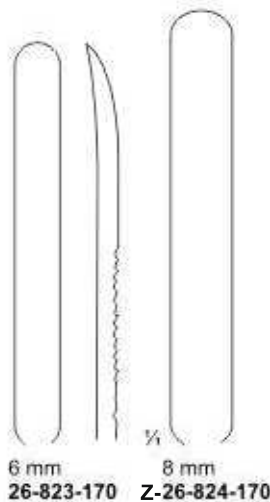

**DOYEN RIB RASPATORY**  
**Z-26-825-170**  
17 cm, 7"



**ADSON ELEVATOR**  
**Z-26-830-170**  
17 cm, 7"

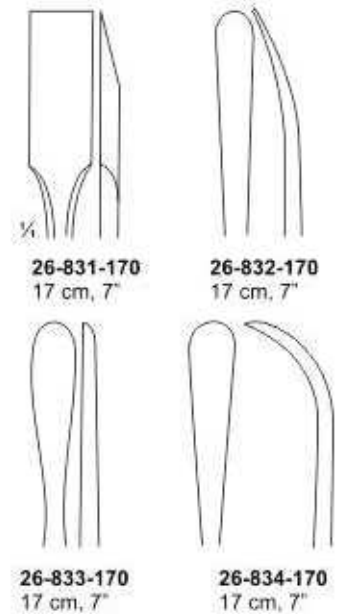

Raspatorien  
Periostótomos

Rugines-raspatoires  
Periostotomi



**ST. THOMAS**  
Z-26-835-160  
16 cm, 6 1/2"  
Pointed



**ST. THOMAS**  
Z-26-836-160  
16 cm, 6 1/2"  
Rounded



**ROBINSON'S**  
Z-26-837-170  
17 cm, 7"



**WILLIGER**  
Z-26-838-130  
13 cm, 5"



**WILLIGER**  
Z-26-839-160  
16 cm, 6 1/2"



**LANE**  
Z-26-840-160  
16 cm, 6 1/2"  
Serrated



**LANE**  
Z-26-841-270  
27 cm, 10 1/2"



**TRETOWAN'S**  
Z-26-842-220  
22 cm, 9"



**BRISTOW'S**  
Z-26-843-240  
24 cm, 9 1/2"



**SEDILLOT**  
Z-26-844-210  
21 cm, 8 1/4"





**KEY**

- Z-26-845-06 6 mm
- Z-26-846-12 12 mm
- Z-26-847-20 20 mm
- Z-26-848-25 25 mm
- 190 cm, 7 1/2" sharp, slightly curved



**PENNYBACKER**

- Z-26-849-06 6 mm
- 17 cm, 6 3/4" sharp, curved



**LANGENBECK**

- Z-26-850-15 15 mm
- 19 cm, 7 1/2" sharp, slightly curved



**CUSHING**

- Z-26-851-01 15 mm round edge
- Z-26-852-02 Square edge
- 18 cm, 7"



**ADSON**

- Z-26-853-170 17 cm, 6 3/4"



**HOEN**

- 26-854-07 7 mm
- 16 cm, 6 1/4"
- 26-855-15 15 mm
- 19 cm, 6 1/4"
- 26-856-20 20 mm
- 19 cm, 6 1/4" Semisharp

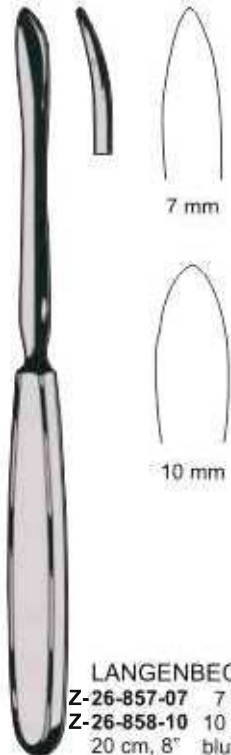

**LANGENBECK**

- Z-26-857-07 7 mm
- Z-26-858-10 10 mm
- 20 cm, 8" blunt



**CUSHING**

- 19 cm, 7 1/2"
- Z-26-859-19 Left
- Z-26-860-19 Right



**Z-26-861-06**

- 6 mm, 185 mm sharp, curved



**Z-26-862-13**

- 13 mm, 200 mm sharp, curved

Raspatorien  
Periostótomos

Rugines-raspatoires  
Periostotomi



1/2

**Z-26-863-200**  
20 cm, 8"  
Medium straight  
blade round edge,  
width 14 mm



1/2

**Z-26-864-200**  
20 cm, 8"  
Medium curved  
blade round edge,  
width 14 mm



1/2

**Z-26-865-180**  
18 cm, 7"  
Small curved  
blade round edge,  
width 6 mm



1/2

**Z-26-866-180**  
18 cm, 7"  
Small curved  
blade straight edge,  
width 6 mm



1/2

**Z-26-867-180**  
18 cm, 7"  
Extra small  
curved blade  
round edge,  
width 3 mm



1/2

**Z-26-868-200**  
20 cm, 8"  
large straight blade  
round edge,  
width 20 mm



1/4

Medium Blade  
Straight Edge, 14 mm  
**26-869-185**  
Straight 18.5 cm, 7 1/2"  
**Z-26-870-185**  
Curved 18.5 cm, 7 1/2"



1/2

**LANGENBECK**  
**Z-26-871-180**  
18 cm, 7"



1/2

**LANGENBECK**  
**Z-26-872-190**  
19 cm, 7 1/2"



1/2

**LAMBOTTE**  
**Z-26-873-210** 21 cm, 8 1/2"  
**Z-26-8741-210** 1.0 cm  
**Z-26-8741-210** 1.5 cm  
**Z-26-875-210** 2.0 cm



1/2

**FARABEUZ**  
**Z-26-876-150**  
15 cm, 6"



1/2

**FARABEUZ**  
**Z-26-877-150**  
15 cm, 6"



1/2

**Z-26-878-160** 5 mm  
**Z-26-879-160** 6 mm  
**Z-26-880-160** 7 mm  
16 cm, 6 1/2"



**CARROLL** Periosteal Elevator  
Z-26-881-140  
14 cm, 5 1/2" sharp, double ended  
3 mm round end, 10 mm flat end



**ADSON** Periosteal 17 cm, 6 1/4"  
Z-26-882-01 Sharp 7 mm straight  
Z-26-883-02 blunt 7 mm curved  
Z-26-884-03 semi-sharp 7 mm straight  
Z-26-885-04 semi-sharp 7 mm curved



**CUSHING** Periosteal Elevator  
Z-26-886-185 18.5 cm, 7 1/4", 15 mm sharp, straight  
Z-26-887-185 curved



**LANGENBECK**  
Periosteal Elevator  
Z-26-888-01 19.5 cm, 7 3/4" blunt edge  
Z-26-889-02 sharp edge



**Key Periosteal Elevator sharp edge**  
Z-26-890-06 17.7 cm, 7" 6.5 mm width  
Z-26-891-09 18.5 cm, 7 1/4" 9.5 mm width  
Z-26-892-12 18.5 cm, 7 1/4" 12.7 mm width  
Z-26-893-19 20.0 cm, 8" 19.0 mm width  
Z-26-894-25 20.9 cm, 8 1/4" 25.0 mm width

# BONE LEVERS, KNEE RETRACTORS & SPINAL RETRACTORS



Knochenhebel, Kniehaken, Spinalhaken

Elevadores para hueso, Separadores para le genou,

Leviers à os, Ecarteurs pour le genou, Ecarteurs spinaux

Elevatori per ossa, Divaricatori per il ginocchio,



**AUFRANC**  
Z-26-895-290  
29 cm, 11 1/2"



**AUFRANC**  
Z-26-896-290  
29 cm, 11 1/2"



**AUFRANC**  
Z-26-897-290  
29 cm, 11 1/2"



**BLOUNT KNEE  
RETRACTOR**  
Z-26-898-175  
17.5 cm, 7"



**BENNETT**  
Z-26-899-260  
24 cm, 9 1/2"  
43 mm, 60 mm,  
65 mm,



Z-26-900-175

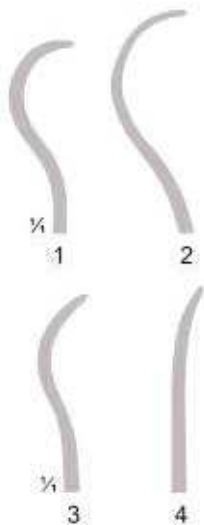

**PERIOSTEAL ELEVATOR**

17.5 cm, 7"

For Metacarpals Small  
8 mm width

Z-26-901-175

For Metacarpals Medium  
10 mm width

Z-26-902-175

Light Curve, Rounded End,  
5 mm width

Z-26-903-175

Contra Angled Curve  
4.5 mm width



Z-26-904-180

18 cm, 7"  
Small, width 6 mm  
short, narrow tip



Z-26-905-180

18 cm, 7"  
Small, width 8 mm  
short, narrow tip



Z-26-906-160

12.5 cm, 5"  
For Small Fragments  
Board Shank



Z-26-907-200

20 cm, 8"  
Width 8 mm  
short, narrow tip



Z-26-908-200

20 cm, 8"  
Width 18 mm short,  
narrow tip

Z-26-909-200

20 cm, 8"  
Width 18 mm long,  
narrow tip

**BONE LEVERS, KNEE RETRACTORS & SPINAL RETRACTORS**

*Knochenhebel, Kniehaken, Spinalhaken*  
*Elevadores para hueso, Separadores para le genou,*

*Leviers à os, Ecarteurs pour le genou, Ecarteurs spinaux*  
*Elevatori per ossa, Divaricatori per il ginocchio,*



**HOHMANN**  
**Z-26-910-150**  
15 cm, 6"



**HOHMANN**  
**Z-26-911-154**  
15.4 cm, 6"  
Short tip



**Z-26-912-180** 18 cm, 7"  
Width 43 mm  
narrow tip  
**Z-26-913-180** 18 cm, 7"  
Width 70 mm  
narrow tip



**Z-26-914-180** 18 cm, 7"  
Width 43 mm  
long shank, angled



**Z-26-915-160** 16 cm, 6 1/2"  
width 22 mm wide tip



**Z-26-916-160** 16 cm, 6 1/2"  
long wire tip for Hip  
Surgery, width 24 mm



**LANGE-HOHMANN**  
**Z-26-917-240** 24 cm, 9 1/4"  
**Z-26-918-240** 26 cm, 10 1/2"  
**Z-26-919-240** 29 cm, 11 1/2"



**RETRACTOR  
FOR KNEE**  
**Z-26-920-270**  
27 cm, 11" Blunt



**ALEXANDER**  
**Z-26-921-200**  
20 cm, 8"



**MATSON**  
**Z-26-922-220**  
22 cm, 9"



**CUSHING VEIN Retractor**  
**Z-26-923-225**  
22.5 cm, 9"  
with fenestrated handle  
Blade 12 mm width x 10 mm



**CUSHING DECOMPRESSION Retractor**  
**Z-26-924-21**  
21.5 cm, 8 1/2"  
with fenestrated blade and handle  
Blade 13 mm width x 22 mm



**SCOVILLE** 24 cm, 9 1/2"  
**Z-26-925-01** straight  
**Z-26-926-02** carved  
7 mm



**TAYLOR**  
17 cm, 6 3/4"  
**Z-26-927-170** 30 x 75 mm  
**Z-26-928-170** 30 x 100 mm



**HIBBS**  
25 x 75 mm, 23 cm, 9"  
**Z-26-929-230**  
**Z-26-930-240** 25 x 80 mm, 24 cm, 9 1/2"



**Meyering**  
**Z-26-931-200** 16 X 50 mm, 20 cm, 8"  
**Z-26-932-230** 25 X 75 mm, 23 cm, 9"  
**Z-26-933-240** 50 X 90 mm, 24 cm, 9 1/2"



**SENN Retractor**  
16 cm, 6 1/4"  
Z-26-934-01 3 sharp prongs  
Z-26-935-02 3 blunt prongs



**LITTLE RETRACTOR**  
Z-26-936-190  
19 cm, 7 1/2"  
Blade 7 mm x 18 mm



**BLADE RETRACTOR**  
18 cm, 7"  
Z-26-937-18 18 mm x 76 mm  
Z-26-938-20 20 mm x 76 mm  
Z-26-939-23 23 mm x 76 mm

Duradissectoren  
 Disecadores Para Duramadre



**FRAZIER**  
 Z-26-940-150  
 15 cm, 6"



**HOEN**  
 Z-26-941-150  
 15 cm, 6"  
 90°



**HORSLEY**  
 Z-26-942-200  
 20 cm, 8"

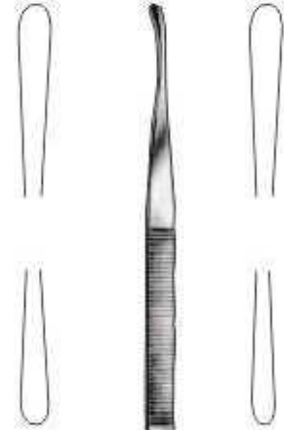

Z-26-943-01  
 wide

Z-26-944-02  
 narrow

**TOENNIS**  
 24 cm, 8 1/2"



**DAVIS**  
 Z-26-945-04 4 mm  
 24.5 cm, 9 3/4"



**OLIVECRONE**  
 Z-26-946-180 18 cm, 7"  
 Z-26-947-240 24 cm, 9 1/2"  
 delicate pattern



**OLIVECRONE**  
 Z-26-948-180 18 cm, 7"  
 Z-26-949-240 24 cm, 9 1/2"  
 heavy pattern





**DISSECTOR**

18.5 cm, 7 1/4"

- Z-26-952-10 1.0 mm
- Z-26-953-15 1.5 mm
- Z-26-954-20 2.0 mm

23 cm, 9"

- Z-26-955-10 1.0 mm
- Z-26-956-15 1.5 mm
- Z-26-957-20 2.0 mm



**RASPATORY, round**

18.5 cm, 7 1/4"

- Z-26-958-20 2.0 mm
- Z-26-959-30 3.0 mm

23 cm, 9"

- Z-26-960-20 2.0 mm
- Z-26-961-30 3.0 mm



**CURETTE**

- Z-26-962-15 18.5 cm, 7 1/4", 1.5 mm
- Z-26-963-15 23.0 cm, 9", 1.5 mm straight



**CURETTE**

- Z-26-964-15 18.5 cm, 7 1/4", 1.5 mm
- Z-26-965-15 23.0 cm, 9", 1.5 mm angled



**HOOK**

- Z-26-950-185 18.5 cm, 7 1/4", 1.5 mm, 90°
- Z-26-951-230 23.0 cm, 9", 1.5 mm, 90° sharp



**HOOK**

- Z-26-966-15 18.5 cm, 7 1/4", 1.5 mm, 90°
- Z-26-967-15 23.0 cm, 9", 1.5 mm, 90° blunt



**TISSUE LIFTER**

- Z-26-968-10 18.5 cm, 7 1/4", 1.0 mm
- Z-26-969-15 1.5 mm

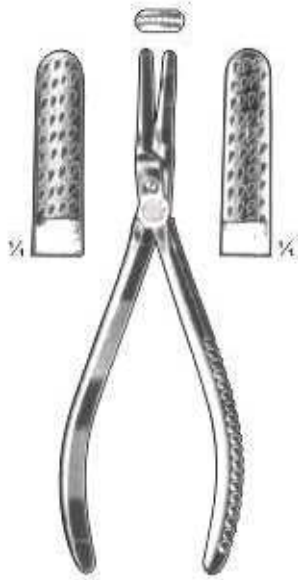

**NAIL EXTRACTING  
FORCEPS**  
Z-26-970-140  
14 cm, 5 1/2"

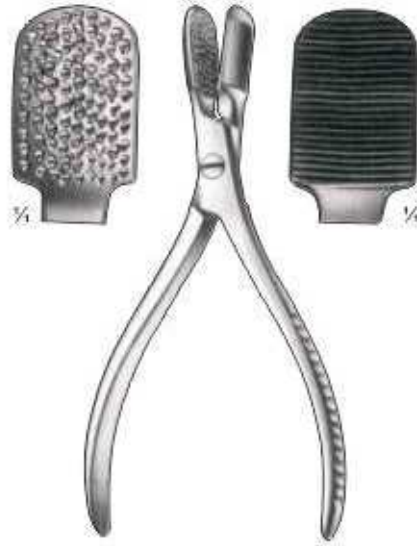

**NAIL EXTRACTING  
FORCEPS**  
Z-26-971-145  
14.5 cm, 5 3/4"

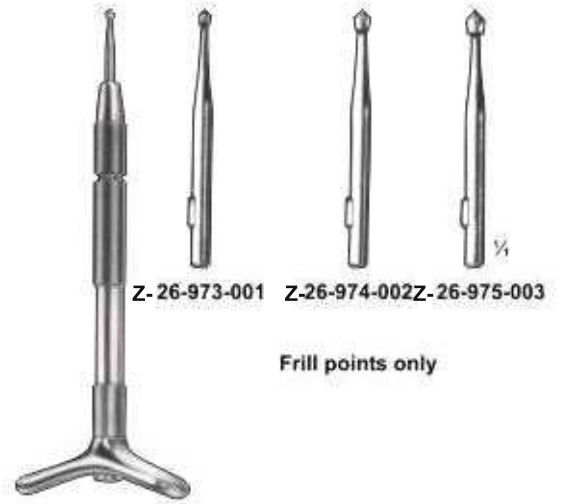

**Z-26-972-000**  
Finger nail drill with 3  
drill points

Z-26-973-001 Z-26-974-002 Z-26-975-003

Frill points only

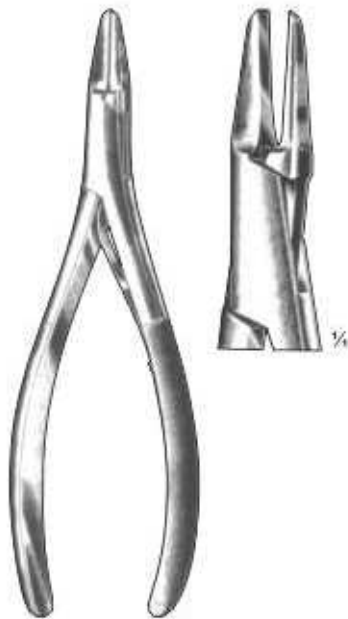

**NAIL SPLITTING  
FORCEPS**  
Z-26-976-135  
13.5 cm, 5 1/4"



**RING CUTTER**  
Z-26-977-170  
17 cm, 6 3/4"



**Z-26-978-000**  
Saw Blade Only  
for 26-977-170



**RING CUTTER**  
Z-26-979-170  
17 cm, 6 3/4"



**26-980-000**  
Saw Blade Only  
for 26-979-170

Flachzangen, Sehrendurchzugzangen  
Alicates de pico plano, Pinzas para pasar tendones

Pinces plates, Pinces pour passer les tendons  
Tenaglie piatte, pinze passa-tendini

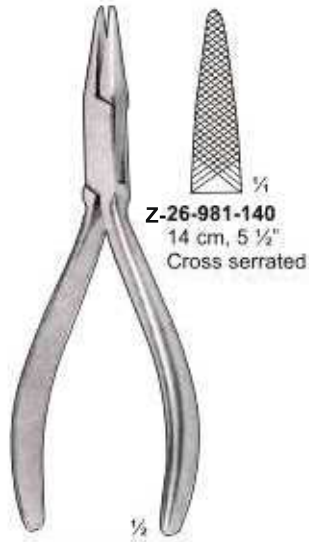

**Z-26-981-140**  
14 cm, 5 1/2"  
Cross serrated

**NEEDLE NOSE PLIERS**



**Z-26-982-190**  
19 cm, 7 1/2"  
Serrated

**NEEDLE NOSE PLIERS**



**FLAT NOSE**  
**Z-26-983-180**  
18 cm, 7"



**Z-26-984-153**  
15.25 cm, 6"  
6 mm

**TENDON**

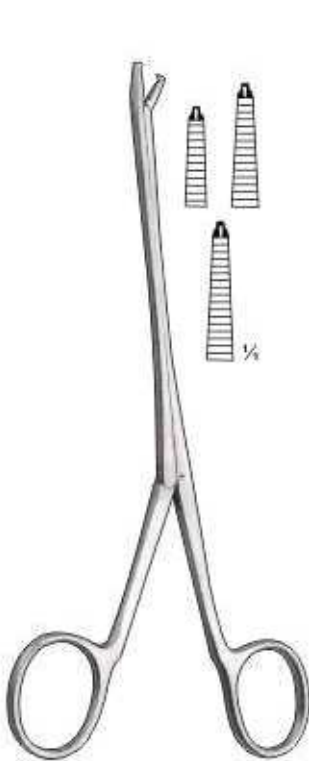

**BRAND**  
**Z-26-985-150** 15 cm, 6"  
**Z-26-986-190** 19 cm, 7 1/2"  
**Z-26-987-240** 24 cm, 9 1/2"



**BRAND**  
**Z-26-988-150** 15 cm, 6"  
**Z-26-989-190** 19 cm, 7 1/2"  
**Z-26-990-240** 24 cm, 9 1/2"



**CARROLL**  
**Z-26-991-130**  
13 cm, 5"  
Curved Shaft  
2 mm x 6 mm

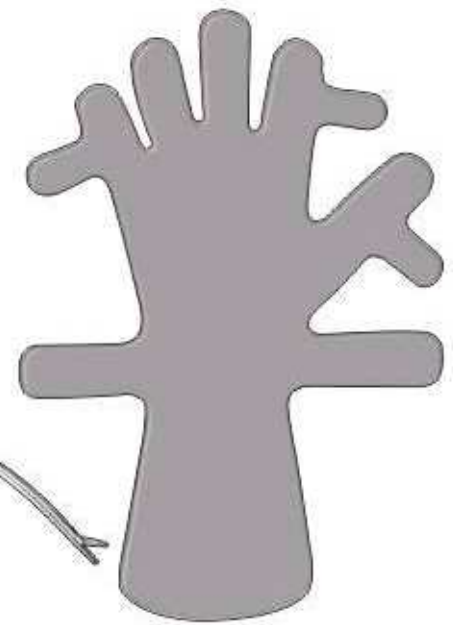

**LEAD HAND**  
**Z-26-992-000**  
Adult Size

**FLAT NOSE, COMBI-FLAT, VISE GRIP PLIERS**

Flachzangen, Tonnenzange, Kombinationszange  
Alicates de pico plano, Combi-Alicate de alambre

Pinces plates, Combi-Pince pour fils  
Tenaglie piatte, Combi-Pinza per fili



**FLAT NOSED  
PARALLEL PLIERS**  
Z-26-993-180 18 cm, 7"  
with lateral wire cutter



**FLAT NOSED  
PARALLEL PLIERS**

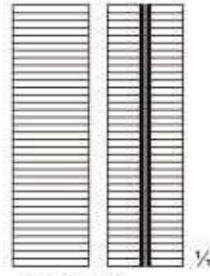

**Z-26-994-170**  
17 cm, 6 1/2"  
Grooved, Serrated



**LOCKING PLIERS**



**Z-26-995-150**  
18 cm, 7"  
With Spring  
serrated



**FLAT NOSED PLIER**  
Z-26-996-210 18 cm, 7"  
parallell, with lateral  
wire cutter



**LOUTE**  
Z-26-997-210  
21 cm, 8 1/4"



**MODEL USA**



**Z-26-998-230**  
23 cm, 9"  
3 Prong

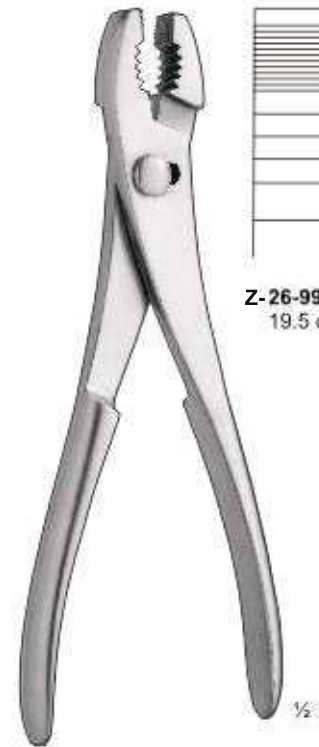

**SLIP JOINT**

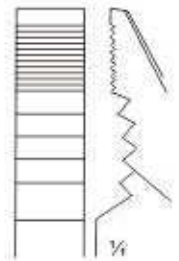

**Z-26-999-195**  
19.5 cm, 8"

**WIRE INSTRUMENTS**



**Z-26-1000-180 EXTRACTION Pliers**  
18 cm, 7"  
**Z-26-1001-180 TC jaws**



**Z-26-1002-130 EXTRACTION Pliers**  
13 cm, 5"  
**Z-26-1003-180** 18 cm, 7"

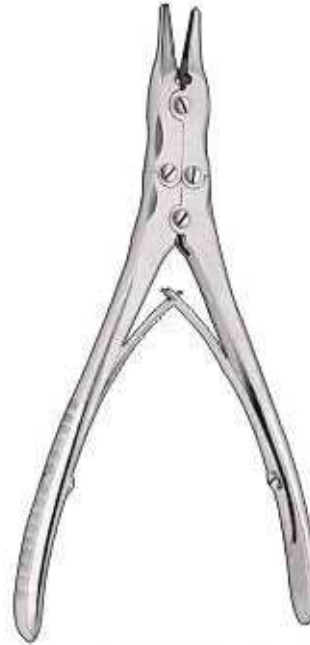

**Z-26-1004-19 EXTRACTION Pliers**  
19 cm, 7 1/2" TC



**Z-26-1005-19 EXTRACTION Pliers**  
20cm, 8" TC



**FLAT-NOSED Pliers**  
parallel,  
**Z-26-1006-180**  
18 cm, 7"  
Stainless Steel



**FLAT-NOSED Pliers**  
parallel  
**Z-26-1007-180**  
with lateral wire cutter,  
18 cm, 7"  
Stainless Steel



**Z-26-1008-18 VISE GRIP**  
18 cm, 7"  
**Z-26-1009-20** 20 cm, 8"  
**Z-26-1010-24** 24 cm, 9 1/2"  
Stainless Steel



**Z-26-1011-180 WIRE TIGHTENING Pliers**  
18 mm, 7"  
T/C

Flachzangen, Tonnenzange, Kombinationszange  
 Alicates de pico plano, Combi-Alicate de alambre

Pinces plates, Combi-Pince pour fils  
 Tenaglie piatte, Combi-Pinza per fili

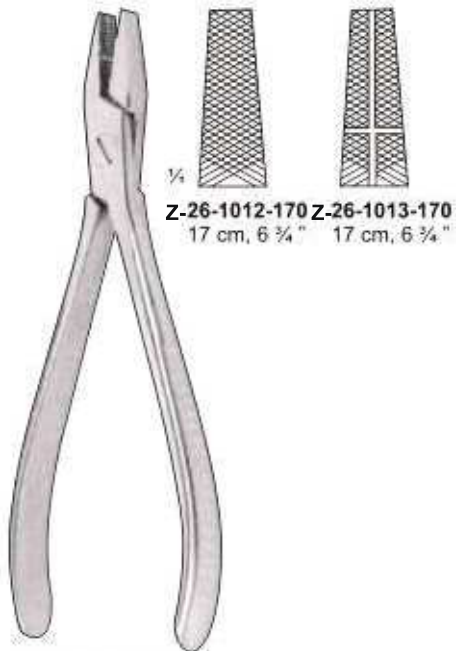

**Z-26-1012-170** 17 cm, 6 3/4"  
**Z-26-1013-170** 17 cm, 6 3/4"

**WIRE FORCEPS**  
**Z-26-1012-170**  
 with serrated jaws  
**Z-26-1013-170**  
 with longitudinal and  
 transvesal grooves

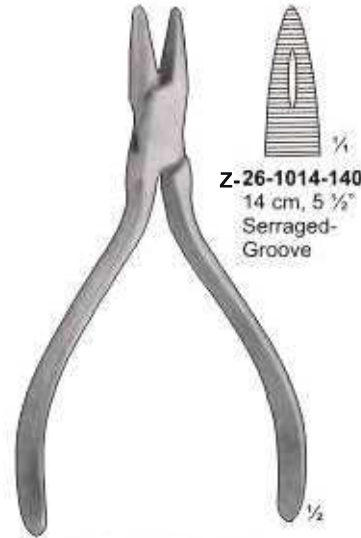

**Z-26-1014-140**  
 14 cm, 5 1/2"  
 Serrated-  
 Groove

**NEEDLE NOSED**



**EXTRACTION PLIERS**  
**Z-26-1015-130** 13 cm, 5"  
**Z-26-1016-180** 18 cm, 7"



**NAIL EXTRACTOR**  
**Z-26-1017-160** 16 cm, 6 1/2"  
 with Longitudinal Grove  
 (for Intramudullary Gliding Nails)

**WIRE INSTRUMENTS**



**Z-26-1018-50**  
Bending Iron  
for Kirschner Wires



**Z-26-1019-20**  
**Z-26-1020-25**  
Pliers with serrated  
jaws and groove  
jaws without groove



**Z-26-1021-18**  
Rounded Pliers with  
serrated jaws



**Z-26-1022-10**  
Wire Bending Cutting  
Pliers soft wire 1.5 mm  
Hard Wire 1.0 mm



**Z-26-1023-10**  
**Z-26-1024-12**  
Universal Scissors  
Universal Scissors  
with TC cutting edges



**Z-26-1025-15**  
Wire Cutter T/C



**Z-26-1026-10**  
Wire Bending Pliers  
soft Wire 1.5 mm  
Hard Wire 1.0 mm



**Z-26-1027-12**  
Wire Cutter  
soft wire 2.0 mm  
hard wire 1.2 mm

Extensiionsnägel, Extensionsbügel,  
 Clavos de extensión, Extribos para extensión

 Clous à os, Etriers à extension,  
 Chiodi per ossa, Archi per estensione
**KIRSCHNER**

Z-26-1028-00 40 x 140 mm  
 Z-26-1029-00 60 x 220 mm

**KIRSCHNER, AMERICAN TYPE**

Z-26-1030-00 Medium 130 mm  
 Z-26-1031-00 Large 185 mm  
 Z-26-1032-00 Extra Large 220 mm  
 Max. Jaw Opening

**KIRSCHNER**

Z-26-1033-00 200 mm x 155 mm  
 Z-26-1034-00 155 mm x 155 mm  
 Z-26-1035-00 135 mm x 130 mm  
 Z-26-1036-00 120 mm x 120 mm  
 Z-26-1037-00 105 mm x 100 mm  
 Z-26-1038-00 95 mm x 110 mm  
 Z-26-1039-00 95 mm x 70 mm

**SCREW NUT WRENCH**

Z-26-1040-00  
 14 x 17 mm

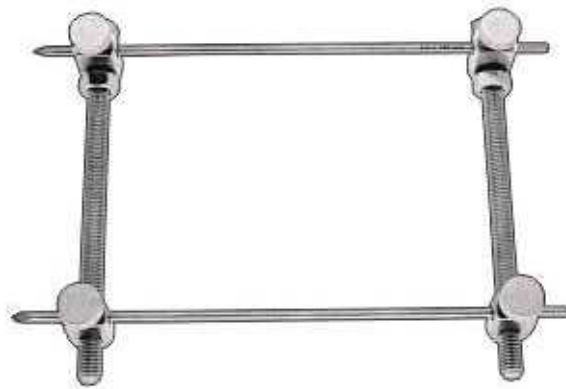
**CHARNLEY-MUELLER**

Z-26-1042-00  
 Compression Clamp

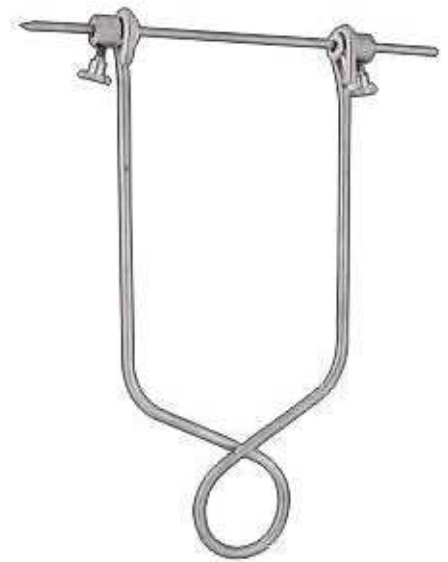

	Inside Length	Inside Width
Z-26-1043-00	90 mm	75 mm
Z-26-1044-00	160 mm	90 mm
Z-26-1045-00	210 mm	110 mm
Z-26-1046-00	210 mm	150 mm





**HARTMANN**  
Z-26-1047-185  
18.5 cm, 7 1/4"

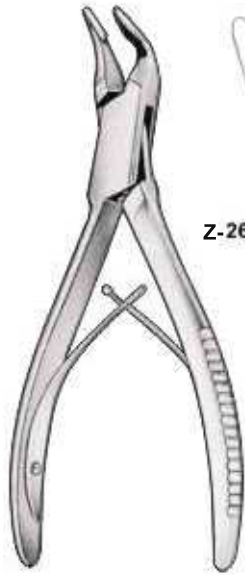

**BLUMENTHAL**  
15 cm, 6"

Z-26-1048-150

Z-26-1049-150



Z-26-1050-150



**LUER**  
15 cm, 6"

Z-26-1051-150 Z-26-1052-150



Z-26-1053-150



**FRIEDMAN & MINI-FRIEDMAN**



Z-26-1054-120  
12 cm, 4 3/4"  
Curved

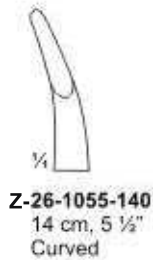

Z-26-1055-140  
14 cm, 5 1/2"  
Curved



**UNIVERSAL**



Z-26-1056-133  
13.25 cm, 5 1/8"  
Angled  
17 mm x 3.5 mm



**BACON**  
Z-26-1057-200  
20 cm, 8"



Z-26-1058-175  
17.5 cm, 7"



Z-26-1059-175  
17 cm, 6 3/4"

**STELLBRINK  
SYNOVCTOMY  
RONGEUR**

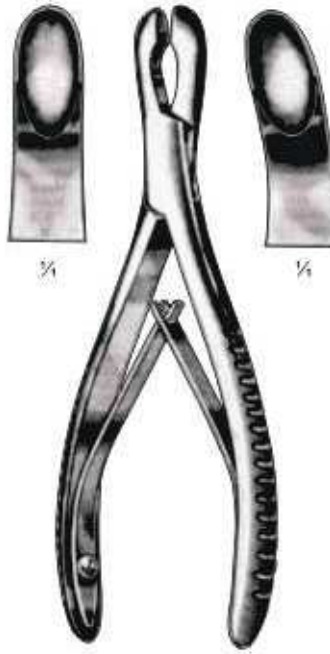

**LUER**  
Z-26-1060-170 17 cm, 6 3/4" straight  
Z-26-1061-170 17 cm, 6 3/4" curved



Z-26-1062-153  
15.5 cm, 6"  
Curved-Small  
9 mm x 3.5 mm

**LUER**



**CLEVELAND**  
Z-26-1063-140  
14 cm, 5 1/2"



**CLEVELAND**  
Z-26-1064-170  
17 cm, 6 3/4"



**MEAD**  
16.5 cm, 6 1/2"



Z-26-1065-165



Z-26-1066-165



**LEMPERT**  
Z-26-1067-190 19 cm, 7 1/2" straight  
Z-26-1068-190 19 cm, 7 1/2" curved

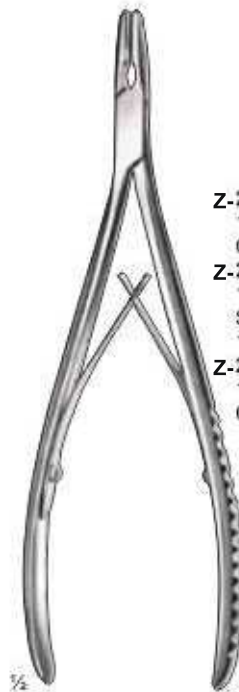

**LEMPERT**

1/4  
Z-26-1069-160  
16 cm, 6 1/2"  
Curved  
Z-26-1070-190  
19 cm, 7 1/2"  
Straight  
12 mm x 3 mm  
Z-26-1071-190  
19 cm, 7 1/2"  
Curved



**ADSON**  
Z-26-1072-200  
20 cm, 8" Straight  
15 mm x 7.5 mm



**BANE**

1/4  
Z-26-1073-180  
18 cm, 7"  
Slightly Curved,



**HAKANSSON**  
Z-26-1074-155  
15.5 cm, 6"



Z-26-1075-230  
23 cm, 9"

STILLE-RUSKIN

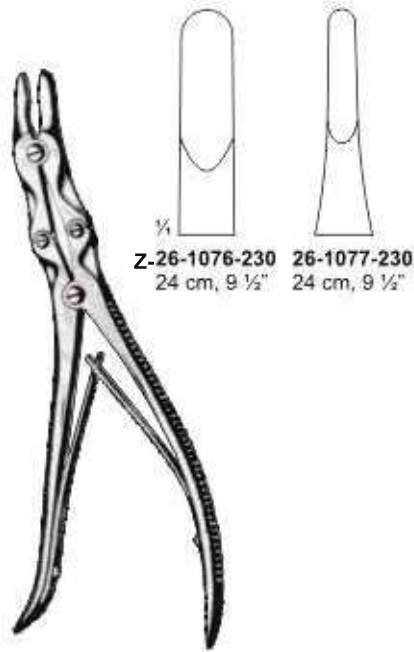

Z-26-1076-230 26-1077-230  
24 cm, 9 1/2" 24 cm, 9 1/2"

LEKSELL-STILLE



Z-26-1078-220 Z-26-1079-220  
22 cm, 8 3/4" 22 cm, 8 3/4"

STILLE-LUER



Z-26-1080-230 26-1081-230  
23 cm, 9" 23 cm, 9"

ECHLIN / STILLE-LUER



BEYER  
RONGEUR  
Z-26-1082-180  
18 cm, 7" curved

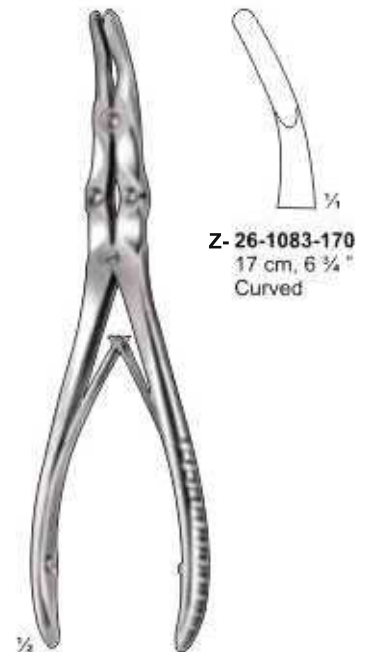

Z-26-1083-170  
17 cm, 6 3/4" Curved

MAYFIELD

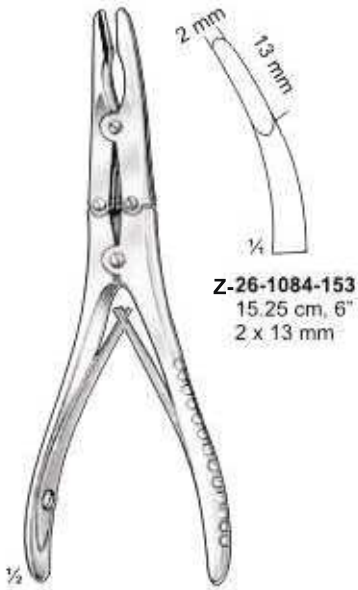

**Z-26-1084-153**  
15.25 cm, 6"  
2 x 13 mm

**KLEINERT-KUTZ**

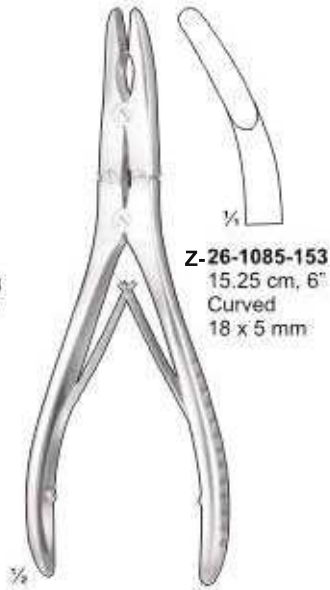

**Z-26-1085-153**  
15.25 cm, 6"  
Curved  
18 x 5 mm

**RUSKIN-MINI**

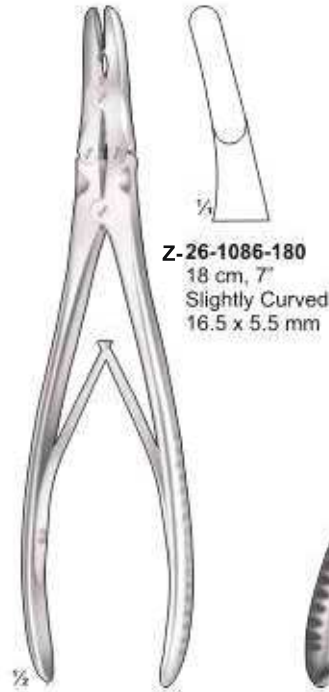

**Z-26-1086-180**  
18 cm, 7"  
Slightly Curved  
16.5 x 5.5 mm

**RUSKIN**



**Z-26-1087-153** **Z-26-1088-153**  
15.25 cm, 6" 15.25 cm, 6"  
Straight Slight Curve

**BÖHLER**



**Z-26-1089-180**  
18 cm, 7"  
Curved

**BEYER**



**Z-26-1090-180**  
18 cm, 7"  
Slightly Curved

**ZAUFAL-JANSEN**



**Z-26-1091-230**  
22.5 cm, 9"

**SEMB**



**Z-26-1092-230**  
23 cm, 9"  
Duckbill  
17 mm x 6 mm

**STILLE**

Hohlmeißelzangen  
 Pinzas gubias



**ECHLIN**  
 23 cm, 9"

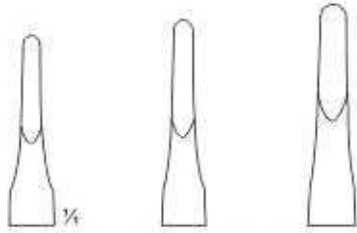

Z-26-1093-230 2 mm  
 Z-26-1094-230 3 mm  
 Z-26-1095-230 4 mm



**LEKSELL**  
 Z-26-1096-220 3 mm  
 Z-26-1097-220 5 mm  
 Z-26-1098-220 8 mm  
 Z-22 cm, 8 1/4"



**MAYFIELD**  
 Z-26-1099-170  
 17 cm, 6 1/4"



**RUSKIN RONGEUR**  
 Z-26-1100-00  
 curved



**MARQUARDT**  
 Z-26-1101-200  
 20 cm, 8"



**Z-26-1102-230**  
23 cm, 9"  
**Z-26-1103-270**  
27 cm, 10 1/2"  
straight

**STILLE-LUER**  
Rongeur Forceps



**Z-26-1104-230**  
23 cm, 9"  
**Z-26-1105-270**  
27 cm, 10 1/2"  
curved

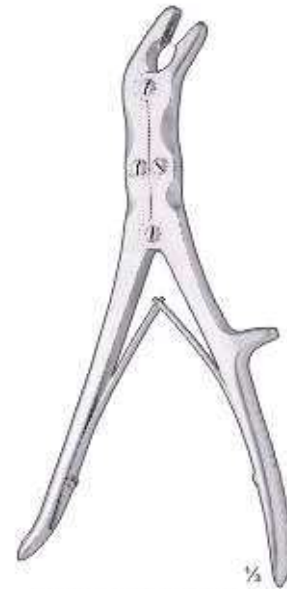

**STILLE RONGEUR**  
Forceps  
**Z-26-1106-230**  
23 cm, 9"  
Double-Action  
jaws 3mm wide  
Jaws angled to side



**LEKSELL RONGEUR**  
Forceps  
**Z-26-1107-230**  
23 cm, 9"  
Double-Action  
Fully Curved  
Jaw 7mm x 13mm wide



**SAUERBRUCH**  
31 cm, 12 1/4"



**Z-26-1108-310**  
Round  
20 mm

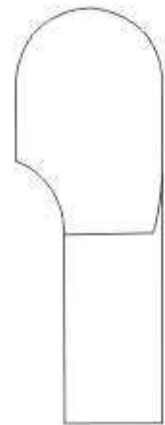

**Z-26-1109-310**  
Straight  
20 mm

Knochensplitterzangen  
Pinzas cortantes para hueso

Pinces coupantes à os  
Cesoie per ossa



**LISTON BONE  
Cutting Forceps**



**Z-26-1110-140**  
14 cm, 5 1/2"



**Z-26-1111-170**  
17 cm, 6 3/4"



**Z-26-1112-190**  
19 cm, 7 1/2"  
**Z-26-1113-220**  
22 cm, 8 3/4"



**LISTON**  
Z-Pi09-597-000



**Z-26-1114-140**  
14 cm, 5 1/2"



**Z-26-1115-170**  
17 cm, 6 3/4"



**Z-26-1116-190**  
19 cm, 7 1/2"



**Z-26-1117-220**  
22 cm, 8 3/4"



**MARKWALDER**

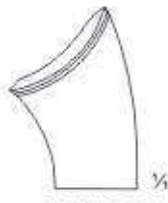

**26-1118-200**  
20 cm, 8"



**LITTAUER / LISTON**



**Z-26-1119-150**  
15 cm, 6"  
Straight,



**CLEVELAND-GARDNER**



**Z-26-1120-160**  
16 cm, 6 1/2"



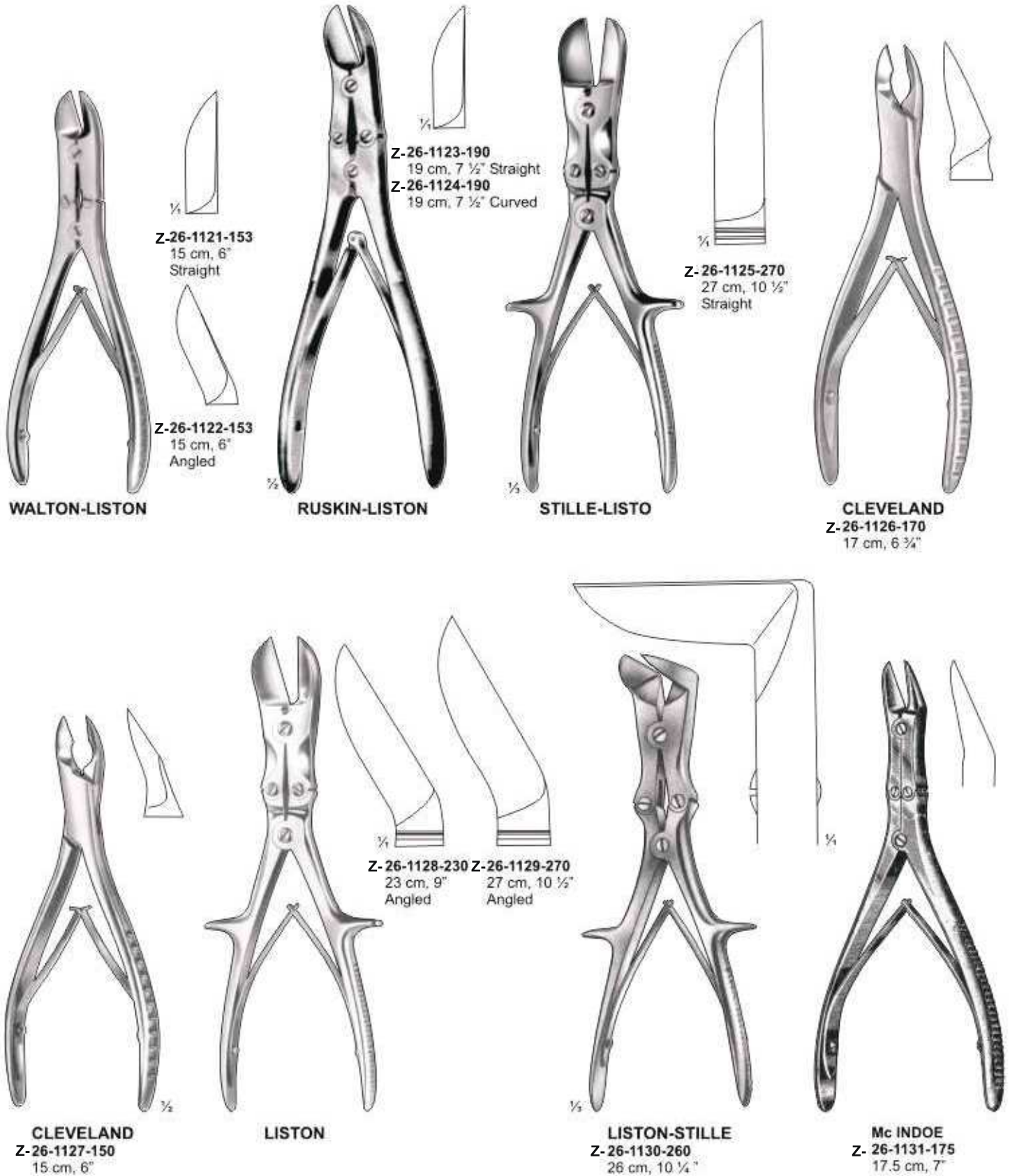

Knochensplitterzangen  
Pinzas cortantes para hueso

Pinces coupantes à os  
Cesoie per ossa

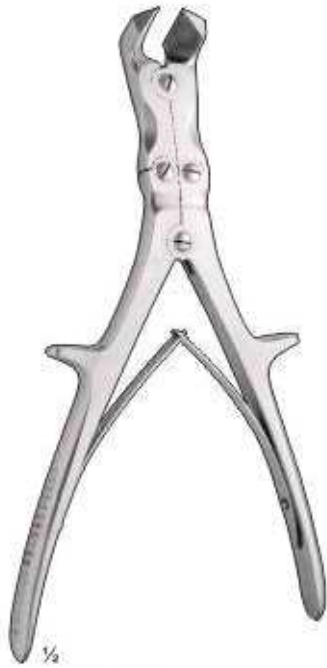

**HORSLEY**  
Bone Cutting Forceps  
Z-26-1132-250  
25 cm, 10"

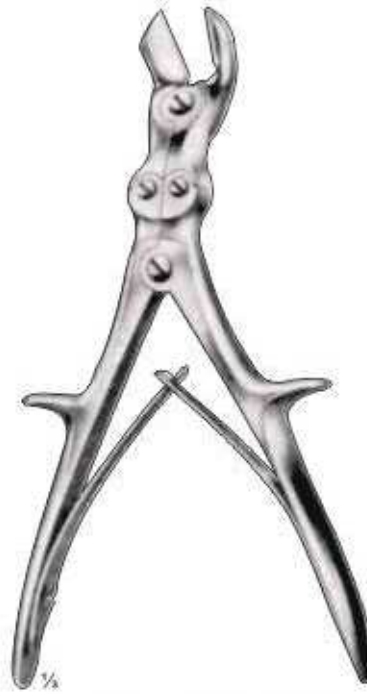

**LISTON-KEY (HORSLEY)**  
Z-26-1133-265  
26.5 cm, 10 1/2"  
Angled, 28 mm



**COTTLE-KAZANJIAN**  
Z-26-1134-190  
19 cm, 7 1/2"

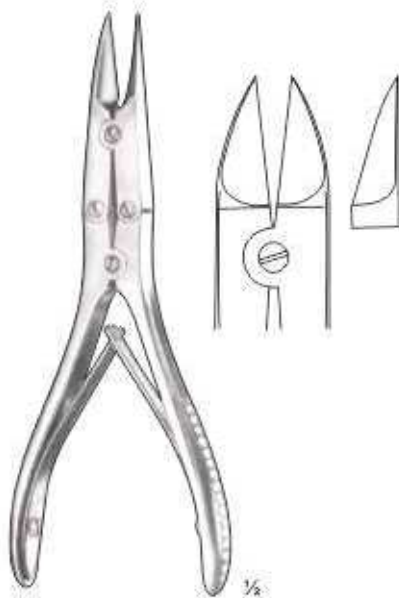

**Z-26-1135-150**  
15 cm, 5 3/4"

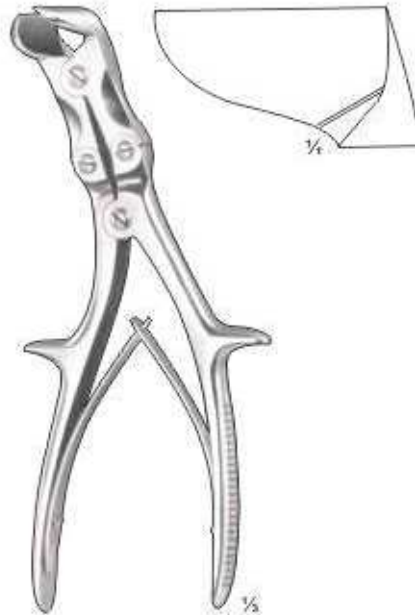

**SEMB**  
Z-26-1136-240  
24 cm, 9 1/2"



**RUSKIN BONE SPLITTING**  
**FORCEPS**  
Z-26-1137-200  
20 cm, 8", Double-Action

**DRESSING SCISSORS / PLASTER SHEARS**

Gipsmesser, Gipssäge, Oszillierende Gipssäge,  
Cuchillos para yeso, Sierra oscilante para yeso

Couteaux pour plâtre, Scies oscillante  
Cotelli per gesso, Sega oscillata per gesso



**GORNEY SEPTAL  
SCISSORS**  
Z-26-1138-197  
19.7 cm, 8"  
double action



**UTILITY SHEARS**  
Z-26-1139-215  
21.5 cm, 8 1/2"  
Serrated blade



**SEUTIN**  
Z-26-1140-230  
23.0 cm, 9"



**WOLFF**  
Z-26-1141-180 18 cm, 7"  
Z-26-1142-240 24 cm, 9 1/2"



**STILLE**  
Z-26-1143-200 20 cm, 8"  
Z-26-1144-230 23 cm, 9"  
Z-26-1145-260 26 cm, 10"  
Z-26-1146-370 37 cm, 14 1/2"



**HENNIG**  
Z-26-1147-280  
28 cm, 11"

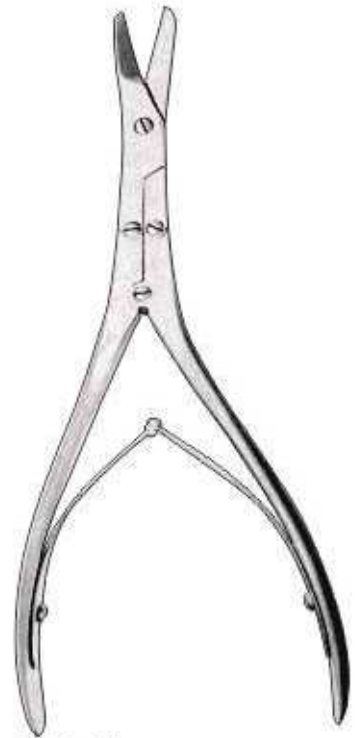

**CAPLAN**  
Z-26-1148-220 22 cm, 8 3/4" Straight  
Z-26-1149-220 22 cm, 8 3/4" Curved

ORTHOPAEDICS WIRE CUTTER



Z-26-1150-150  
15 cm, 6"



**DIAMANT PIN CUTTER**  
Z-26-1151-160  
16 cm, 5 1/2"

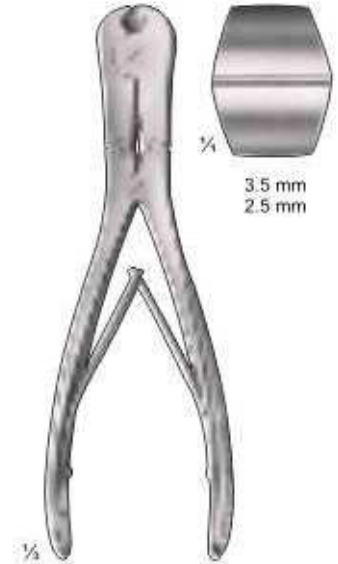

Z-26-1152-220  
22 cm, 9 1/4"



Z-26-1153-320  
32 cm, 12 1/4"  
3.0 mm, 3.0 mm



Z-26-1154-235  
23.5 cm, 9 1/4"



Z-26-1155-140  
14 cm, 5 1/2"  
1.2 mm

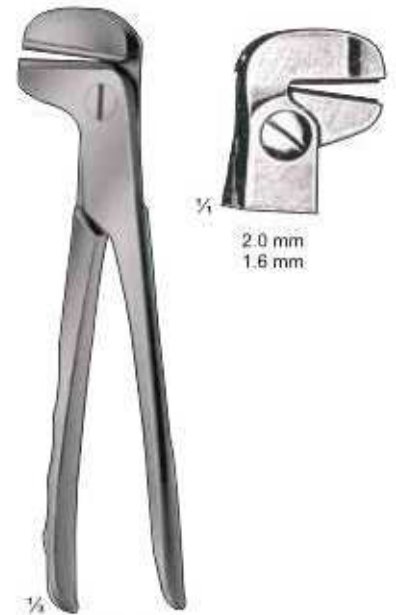

Z-26-1156-240  
24 cm, 9 1/2"

# FLAT NOSE PLIERS & WIRE CUTTING PLIERS T.C. INSERTED

*Pinces plates, Alicates planos, Flachzangen.*

*Pinces coupantes, Alicates para cortar alambre, Drahtkneifzangen*

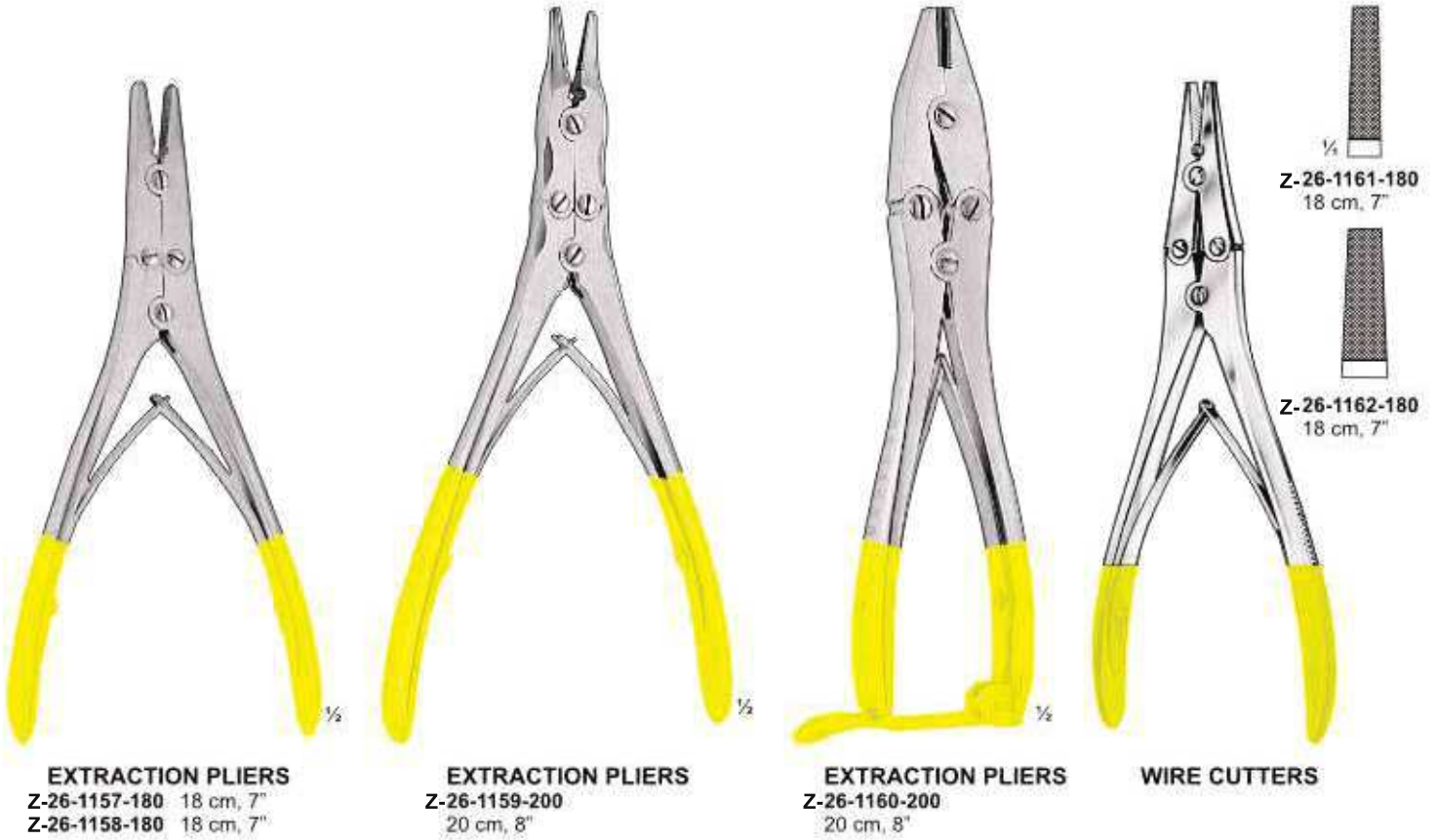

WIRE CUTTING PLIERS T.C INSERTED

Pinces coupantes, Alicates para cortar alambre, Drahtkneifzangen



**UNIVERSAL SCISSORS**  
 Z-26-1167-100 10 cm, 4"  
 Z-26-1168-120 12 cm, 5"



**WIRE CUTTER**  
 Z-26-1169-180  
 18 cm, 7"



**WIRE CUTTERS**  
 Z-26-1170-180 18 cm, 7"  
 Z-26-1171-210 21 cm, 8 1/2"

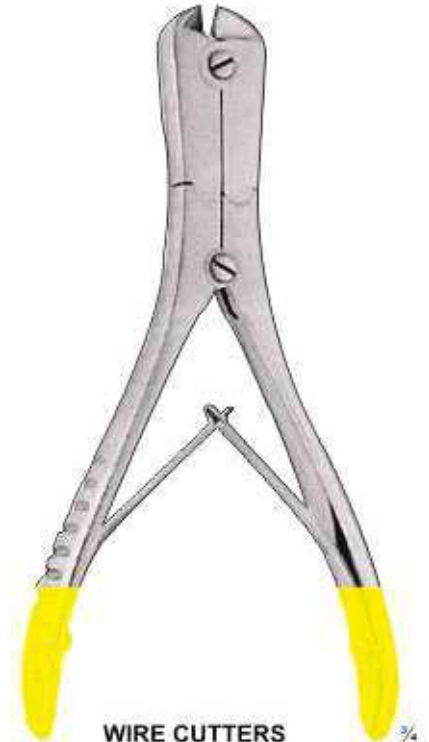

**WIRE CUTTERS**  
 Z-26-1172-140  
 14 cm, 5 1/2"

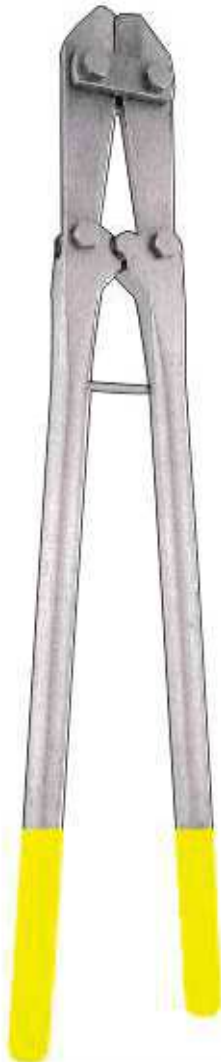

**WIRE CUTTERS**  
 Z-26-1173-460 46 cm, 18"  
 Z-26-1174-560 56 cm, 22"

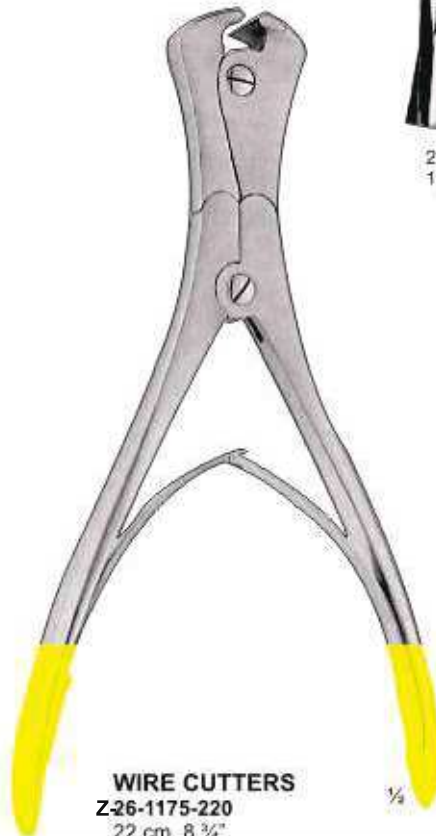

**WIRE CUTTERS**  
 Z-26-1175-220  
 22 cm, 8 3/4"



2.0 mm  
 1.6 mm



Z-26-1176-240  
 24 cm, 9 1/2"



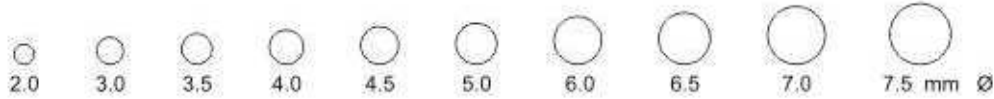

**BOUCHERON**

- Z-27-001-001 Set of 4
- Z-27-002-002 3.5 mm
- Z-27-003-003 4.5 mm
- Z-27-004-004 5.5 mm
- Z-27-005-005 6.5 mm



**PLOITZER**

- Z-27-006-001 Set of 4
- Z-27-007-002 2 mm
- Z-27-008-003 3 mm
- Z-27-009-004 4 mm
- Z-27-010-005 5 mm



**HARTMANN**  
for children

- Z-27-011-001 Set of 3
- Z-27-012-002 2 mm
- Z-27-013-003 3.5 mm
- Z-27-014-004 5 mm



**HARTMANN**

- Set of 4, For Adults
- Z-327-015-001 4.0 mm
- Z-327-016-002 5.0 mm
- Z-327-017-003 6.0 mm
- Z-327-018-004 7.5 mm

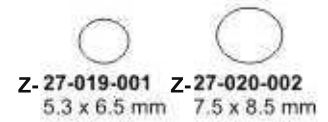

- Z-27-019-001 5.3 x 6.5 mm
- Z-27-020-002 7.5 x 8.5 mm

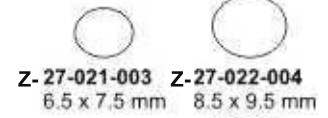

- Z-27-021-003 6.5 x 7.5 mm
- Z-27-022-004 8.5 x 9.5 mm



**ZOLLNER**  
Set of 6, Alu Black

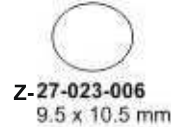

- Z-27-023-006 9.5 x 10.5 mm



- Z-27-024-007 10.5 x 11.5 mm



**GRUBER AURAL SPECULA**

Black finish, diam, 38 mm

- Z-27-025-001 Set of 4
- Z-27-026-002 3 mm
- Z-27-027-003 4 mm
- Z-27-028-004 5 mm
- Z-27-029-005 7 mm



**ROSEN**

Black finish, slotted round ends 35 mm

- Z-27-030-001 Set of 4
- Z-27-031-002 3 mm
- Z-27-032-003 4 mm
- Z-27-033-004 5 mm
- Z-27-034-005 7 mm

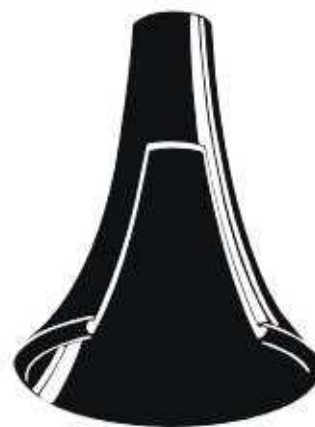

**ROSEN**

slotted round ends  
Black finish, 35 mm

- Z-27-035-001 Set of 4
- Z-27-036-002 4 mm
- Z-27-037-003 5 mm
- Z-27-038-004 6 mm
- Z-27-039-005 7 mm

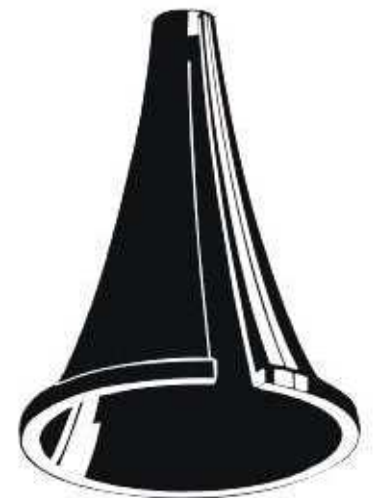

**TUMARKIN**

Tapered Slot

- | Z-27-040-001 | Size | Set of 8 |
|--------------|------|----------|
| Z-27-041-002 | 0    | 4.5 mm   |
| Z-27-042-003 | 1    | 6.5 mm   |
| Z-27-043-004 | 2    | 7.0 mm   |
| Z-27-044-005 | 3    | 7.5 mm   |
| Z-27-045-006 | 4    | 8.0 mm   |
| Z-27-046-007 | 5    | 8.5 mm   |
| Z-27-047-008 | 6    | 9.0 mm   |
| Z-27-048-009 | 7    | 11. mm   |





Z-27-049-001

Z-27-053-005  
Rubber Bulb with rubber  
tube and connection cone



Z-27-050-002  
Ear Speculum,  
Ø 6,5 mm



Z-27-051-003  
Ear Speculum,  
Ø 7 mm



Z-27-052-004  
Ear Speculum,  
Ø 8 mm

**SIEGLE**

Single Part:

Z-27-049-001 to  
Z-27-053-005 Diagnostic Head Complete Set  
Aural magnifier, anastigmatic,  
complete with:

Z-27-049-001 1 diagnostic head

Z-27-050-002 to  
Z-27-052-004 3 ear specula

Z-27-053-005 1 rubber bulb with rubber tube and  
connection cone



**POLITZER**  
Z-27-054-001  
Air Douche, with  
metal mount



**Metal Nasal Tips**  
Z-27-055-002 Ø 18 mm  
Z-27-056-003 Ø 21 mm  
Z-27-057-004 Ø 23 mm



Z-27-058-005  
Metal Connector,  
eustachian catheter to  
Politzer air douche

Z-27-059-001 Ø 2 mm

Z-27-060-002 Ø 2,5 mm

Z-27-061-003 Ø 3 mm

Z-27-062-004 Ø 4 mm

Z-27-063-005 Ø 5 mm

**Hartmann**  
Eustachian Catheters.

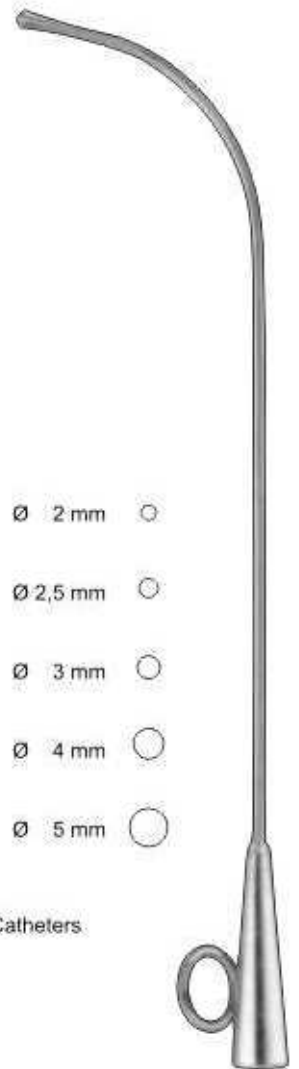



**HARTMANN / FRENCH**  
Z-27-064-128  
C 128



**LUCAE**  
Z-27-065-128  
C 128  
Variable up to h  
(= Engl. B)



**HARTMANN**  
Z-27-066-128  
C 128  
Variable up to h  
(= Engl. B)

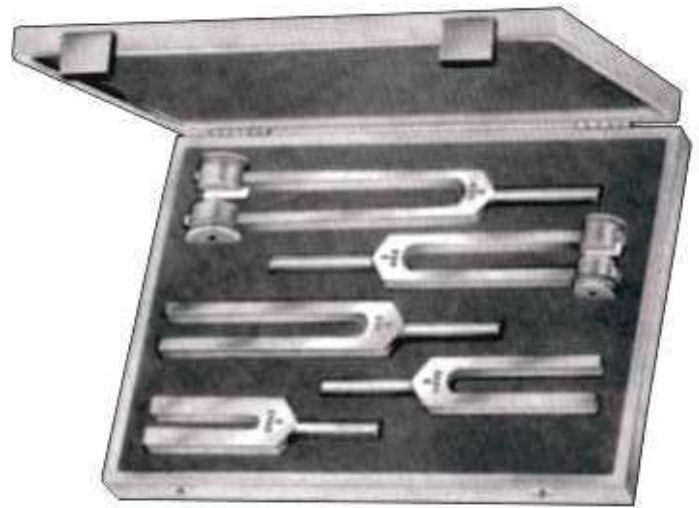

Z-27-068-000 = Set 5

- Z-27-069-0128 C 128
- Z-27-070-0256 C 256
- Z-27-071-0512 C 512
- Z-27-072-1024 C 1024
- Z-27-073-2048 C 2048



Z-27-067-064  
C 64



Z-27-069-128  
C 128

Aluminum



Z-27-070-256  
C 256

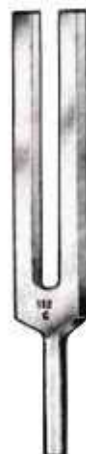

Z-27-071-512  
C 512



Z-27-072-1024  
C 1024



Z-27-073-2048  
C 2048



Z-27-074-4096  
C 4096



HARTMANN    LUCAE    HARTMANN-FRENCH

C <sup>2</sup>	16			27-087-016
C <sup>1</sup>	32			27-088-032
C	64			27-089-064
C	128 c	27-075-128	27-081-128	27-090-128
C <sup>1</sup>	256 c <sup>1</sup>	27-076-256	27-082-256	27-091-256
C <sup>2</sup>	512 c <sup>1</sup>	27-077-512	27-083-512	
C <sup>3</sup>	1024 c <sup>1</sup>	27-078-1024	27-084-1024	
C <sup>4</sup>	2048 c <sup>1</sup>	27-079-2048	27-085-2048	
C <sup>5</sup>	4096 c <sup>1</sup>	27-080-4096	27-086-4096	



**HARTMANN**  
Z-27-092-000 = Set 6

Z-27-075-128	128C
Z-27-076-256	256C <sup>1</sup>
Z-27-077-512	512C <sup>1</sup>
Z-27-078-1024	1024C <sup>1</sup>
Z-27-079-2048	2048C <sup>1</sup>
Z-27-080-4096	4096C <sup>1</sup>

**LUCAE**  
Z-27-093-000 = Set 6

Z-27-081-128	128C
Z-27-082-256	256C <sup>1</sup>
Z-27-083-512	512C <sup>1</sup>
Z-27-084-1024	1024C <sup>1</sup>
Z-27-085-2048	2048C <sup>1</sup>
Z-27-086-4096	4096C <sup>1</sup>

**HARTMANN-FRENCH**  
Z-27-094-000 = Set 7

Z-27-087-016	16C <sup>1</sup>
Z-27-088-032	32C <sup>1</sup>
Z-27-089-064	64C
Z-27-090-128	128C
Z-27-091-256	256C <sup>1</sup>



**RYDEL-SEIFFER**  
Z-27-095-001  
C 65 / C 128  
With Clamps = C 64  
Without Clamps = C 128



Z-27-096-001

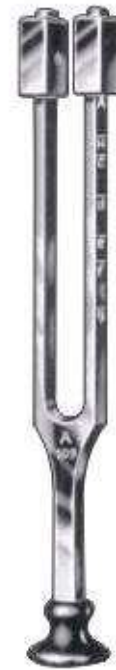

**KOENIG**  
Z-27-097-001  
A 109  
Variable up to g



Z-27-098-001  
a' 109

Trommelfellnadeln,  
Agujas Para Timpano.

Aiguilles Pour Le Tympan,  
Aghi Per Timpano.

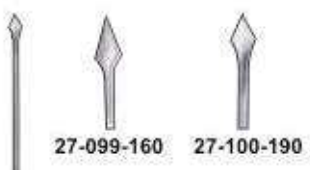

27-099-160 27-100-190



**LUCAE**  
27-099-160  
for children, 16 cm, 6 1/2"  
27-100-190  
for adults, 19 cm, 7 1/2"  
Tympanum Perforators, bayonet-shaped  
27-101-180  
for children, 18 cm, 7"  
Tympanum Perforator, bayonet-shaped,  
handle 90 angled to the lancet



**AGNEW**  
Z-27-102-190  
Tympanum Perforator, angular  
19 cm, 7 1/2"



**POLITZER**  
Z-27-103-165  
16.5 cm, 6 1/2"



**POLITZER**  
Z-27-104-165  
16.5 cm, 6 1/2"



**POLITZER**  
Z-27-105-160  
16 cm, 6 1/2"



**BUCK**  
Z-27-106-150  
15 cm, 6"



**SEXTON**  
Z-27-107-180  
18 cm, 7"



**SEXTON**  
Z-27-108-170  
17 cm, 6 3/4"



**GERZOG-SEXTON**  
Z-27-109-170  
17 cm, 6 3/4"



**POLITZER**  
Z-27-110-160  
16 cm, 6 1/2"

Trommelfellnadeln, Ohrküretten  
Agujas Para Timpano, Curettes Auriculares

Aiguilles Pour Le Tympan, Curettes Auriculaires  
Aghi Per Timpano, Cuette Auricolari



**BARBARA**

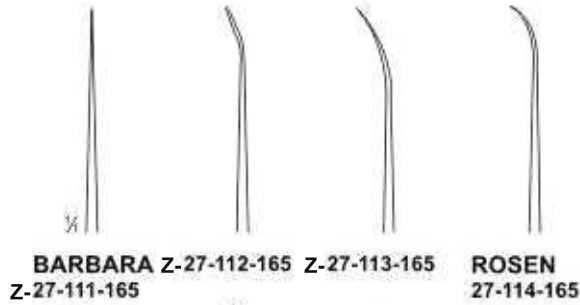

**BARBARA** Z-27-111-165  
Z-27-112-165 Z-27-113-165  
Z-27-114-165  
Z-27-115-165 Z-27-116-165 Z-27-117-165  
Z-27-118-165 Z-27-119-165 Z-27-120-165  
Z-27-121-165 Z-27-122-165 Z-27-123-165  
Z-27-124-165 Z-27-125-165 Z-27-126-165  
Z-27-127-165 Z-27-128-165 Z-27-129-165  
Z-27-130-165 Z-27-131-165

**ROSEN** 27-114-165  
Z-27-132-165  
Z-27-133-165

25° 45° 90°

0.3 mm 0.6 mm 1.0 mm 1.2 mm 1.5 mm 2.0 mm 2.5 mm



**LEMPERT**  
17 cm, 6 1/2"

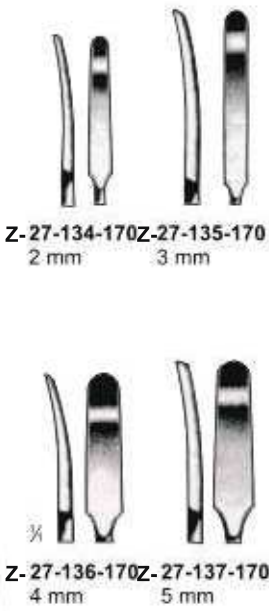

Z-27-134-170 Z-27-135-170  
2 mm 3 mm  
Z-27-136-170 Z-27-137-170  
4 mm 5 mm



**SHAPLEIGH**  
13 cm, 5 1/4"

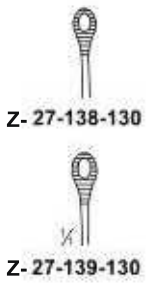

Z-27-138-130  
Z-27-139-130



**BUCK**  
16.5 cm, 6 1/2"

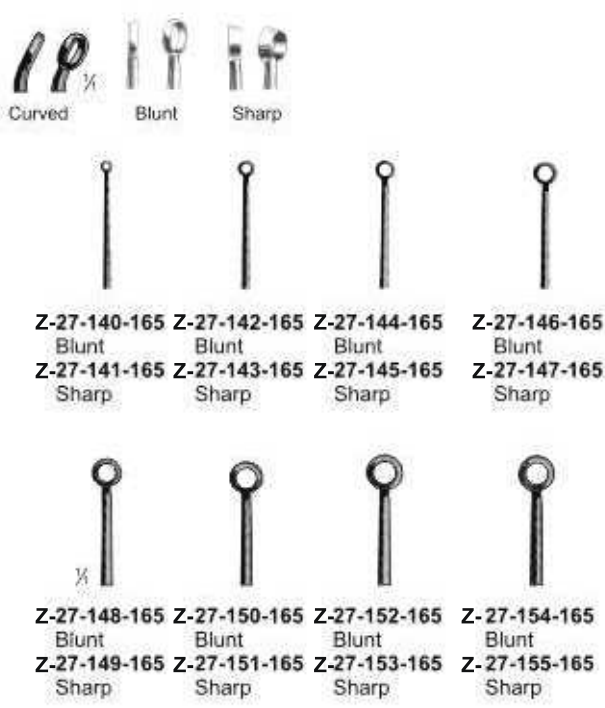

Curved Blunt Sharp  
Z-27-140-165 Blunt Z-27-141-165 Sharp  
Z-27-142-165 Blunt Z-27-143-165 Sharp  
Z-27-144-165 Blunt Z-27-145-165 Sharp  
Z-27-146-165 Blunt Z-27-147-165 Sharp  
Z-27-148-165 Blunt Z-27-149-165 Sharp  
Z-27-150-165 Blunt Z-27-151-165 Sharp  
Z-27-152-165 Blunt Z-27-153-165 Sharp  
Z-27-154-165 Blunt Z-27-155-165 Sharp



**LANGENBECK**  
Z-27-156-130  
13 cm, 5 1/4"



**BARTH**  
Z-27-157-180  
18 cm, 7"



**JANDEN**  
Z-27-158-150  
15 cm, 6"



**EAR HOOKLETS, TYMPANUM NEEDLE**

Ohrhäkchen, Trommelfellnadeln  
Ganchitos Auriculares, Agujas Para Timpano

Crochets Auriculaires, Aiguilles Pour Le Tympan  
Uncini Auricolari, Aghi Per Timpano

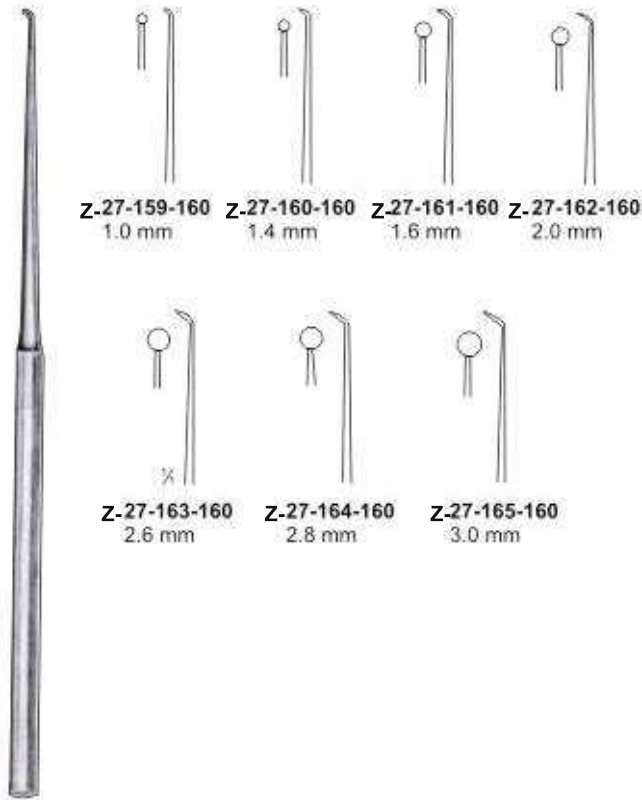

Z-27-159-160 1.0 mm  
Z-27-160-160 1.4 mm  
Z-27-161-160 1.6 mm  
Z-27-162-160 2.0 mm  
Z-27-163-160 2.6 mm  
Z-27-164-160 2.8 mm  
Z-27-165-160 3.0 mm

**ROSEN**  
16 cm, 6 1/4"

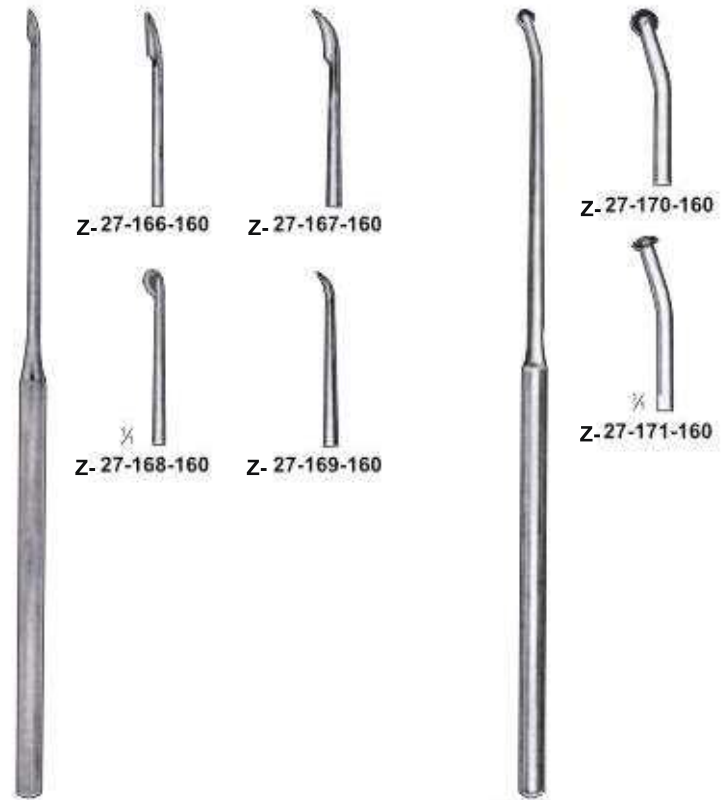

Z-27-166-160  
Z-27-167-160  
Z-27-170-160  
Z-27-168-160  
Z-27-169-160  
Z-27-171-160

**PLESTER**  
16 cm, 6 1/4"

**SCHUKNECHT**  
16 cm, 6 1/4"



**SCHUKNECHT**  
Z-27-172-160  
16 cm, 6 1/4"

**SCHUKNECHT**  
Z-27-173-160  
16 cm, 6 1/4"

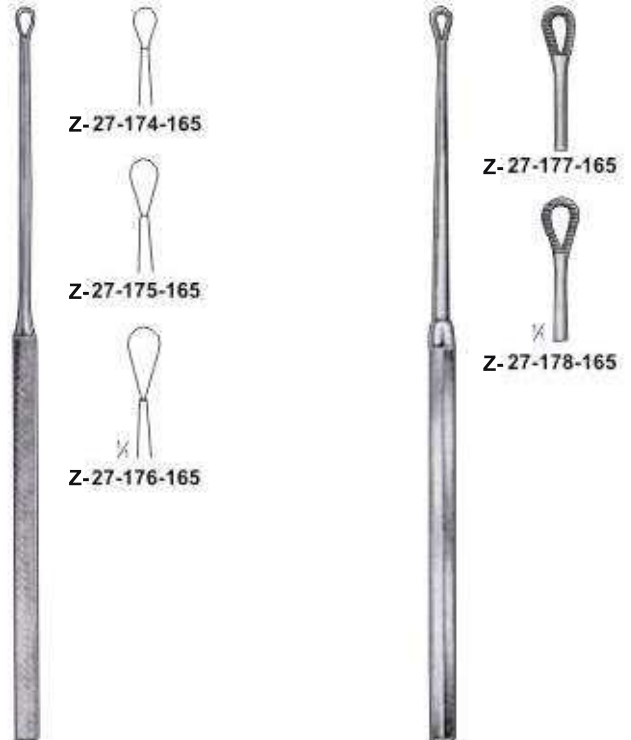

Z-27-174-165

Z-27-175-165

Z-27-176-165

Z-27-177-165

Z-27-178-165

**BILLEAU**  
16.5 cm, 6 1/2"

**SNELLEN**  
16.5 cm, 6 1/2"



**GROSS**  
Z-27-179-165  
16.5 cm, 6 1/2"



**HARTMANN**  
Z-27-180-165  
16.5 cm, 6 1/2"



**ZAUFAL**  
Z-27-181-165  
16.5 cm, 6 1/2"



**WAGENER**  
14 cm, 5 1/2"

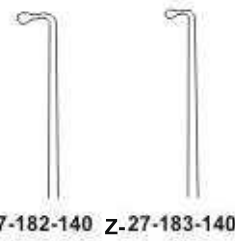

Z-27-182-140 Z-27-183-140



Z-27-184-140 Z-27-185-140



**LUCAE**  
14 cm, 5 1/2"

Z-27-186-140

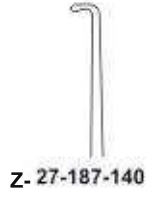

Z-27-187-140



Z-27-188-140



**FISCH**  
18 cm, 7"

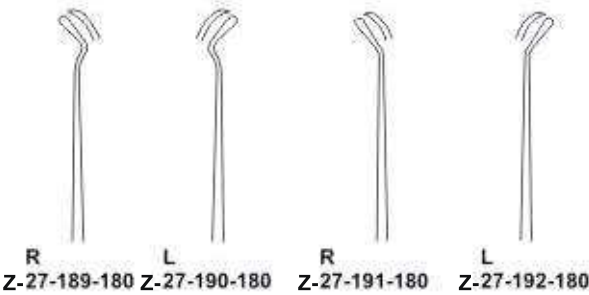

R Z-27-189-180 L Z-27-190-180 R Z-27-191-180 L Z-27-192-180



**ROSEN**  
18 cm, 7"

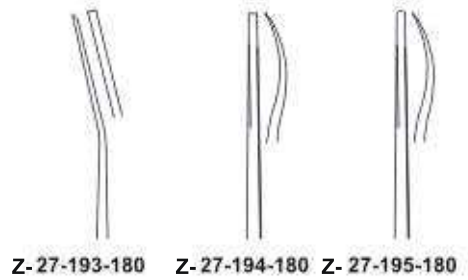

Z-27-193-180 Z-27-194-180 Z-27-195-180

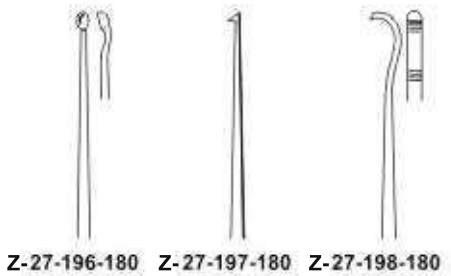

Z-27-196-180 Z-27-197-180 Z-27-198-180

Ohrpolypenzangen  
Pinzas Para Pólipos Auriculares

Pinces Pour Polypes Auriculaires  
Pinze Per Polipi Auricolari

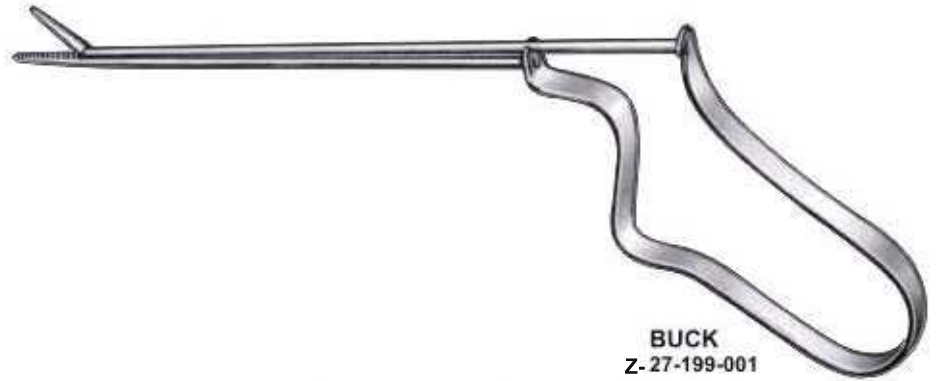
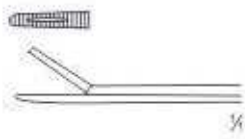

**BUCK**  
Z-27-199-001

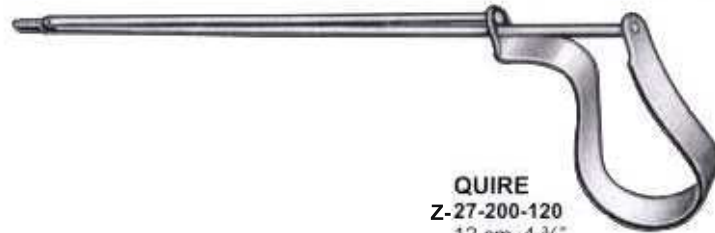

**QUIRE**  
Z-27-200-120  
12 cm, 4 1/2"



**ZÖLLNER**  
Z-27-218-000



**Z-27-201-001**  
45°/0.5 mm



**Z-27-209-009**  
90°



**Z-27-202-002**  
45°/1.0 mm



**Z-27-210-010**  
90°



**Z-27-203-003**  
45°/0.5 mm



**Z-27-211-011**



**Z-27-204-004**  
45°/1.0 mm



**Z-27-212-012**



**Z-27-205-005**  
90°/0.5 mm



**Z-27-213-013**



**Z-27-206-006**  
90°/0.5 mm



**Z-27-214-014**



**Z-27-207-007**  
90°/1.0 mm



**Z-27-216-016**



**Z-27-208-008**  
90°/1.0 mm



**Z-27-217-017**



Ohrspritzen, alligator-ohrfaßzangen  
Seringas à oreilles, Pinces crocodiles à oreilles

Siringhe per orecchi, Pinze alligatore per orecchi  
Jeringas para el oído, Pinzas de boca de cocodrilo para el oído



**REINER**  
Z-27-219-001  
Tip Only



**REINER**  
Z-27-220-002  
Tip Only



Z-27-221-003  
Shield



**Z-27-222-000** 50CC Complete  
**Z-27-223-000** 100CC Complete  
75CC Complete 150CC Complete  
With Tip & Shield



**HARTMANN-WULLSTEIN**  
Z-27-224-085



**HARTMANN-WULLSTEIN**  
Z-27-225-085



**HARTMANN**  
Z-27-226-085  
Z-27-227-140



**HARTMANN**  
Z-27-228-085  
Z-27-229-140



**HARTMANN-NOYES**  
Z-27-230-085



**DUCKBILL**  
Z-27-231-085



**WEINGÄRTNER**  
Z-27-232-085



**HARTMANN**  
Z-27-233-085 = 2.0 mm  
Z-27-234-140 = 2.5 mm  
Z-27-235-165 = 3.0 mm



**HARTMANN**  
Z-27-236-085 = 2.0 mm  
Z-27-237-140 = 2.5 mm  
Z-27-238-165 = 3.0 mm



**STRÜMPEL**  
Z-27-239-085



**HARTMAN**  
Z-27-240-085



**HARTMANN**  
Z-27-241-085



**HARTMANN-HOFFMANN**  
Z-27-242-085

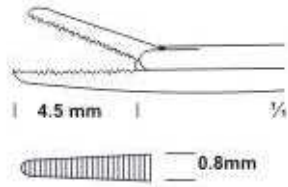

**Z-27-243-080**  
 8 cm, 3"  
 Straight-Serrated  
 4.5 x 0.8 mm

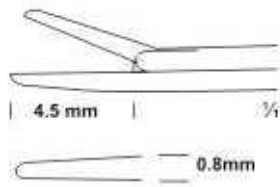

**Z-27-244-080**  
 8 cm, 3"  
 Straight-Smooth  
 4.5 x 0.8 mm

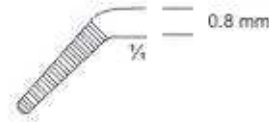

**Z-27-245-080**  
 left

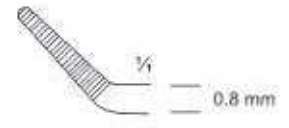

**Z-27-246-080**  
 right

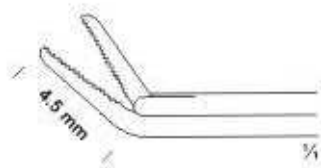

**Z-27-247-080**  
 curved up

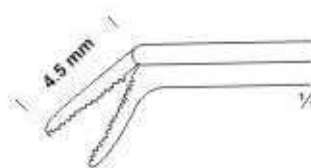

**Z-27-248-080**  
 curved down

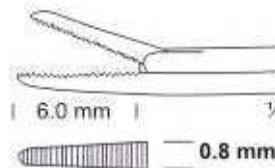

**Z-27-249-080**  
 8 cm, 3"  
 Straight-Serrated  
 6 x 0.8 mm

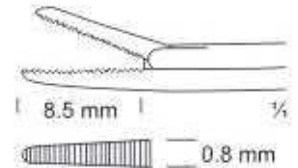

**Z-27-250-080**  
 8 cm, 3"  
 Straight-Serrated  
 8.5 x 0.8 mm

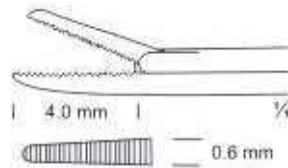

**Z-27-251-080**  
 8 cm, 3"  
 Straight-Serrated  
 4 x 0.6 mm

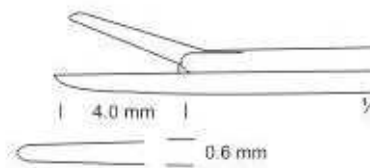

**Z-27-252-080**

**Z-27-253-001**  
 7.5 cm, 3"  
 With Stylus  
 1.0 mm

**Z-27-254-002**  
 7.5 cm, 3"  
 With Stylus  
 1.5 mm

**Z-27-255-003**  
 7.5 cm, 3"  
 With Stylus  
 2.0 mm



**MICRO-EAR FORCEPS**

**MICRO EAR FORCEPS, MASTOID RONGEURS**

Mikro-Ohrzängchen, Ohr-Knochenstanzen

Micro Pinzas Auriculares, Pinzas Cortantes Para Huesos

Micro Pincers Auriculaires, Ostéotomes Emporte-pièces

Micro Pinze Auricolari, Pinze Osteotomi

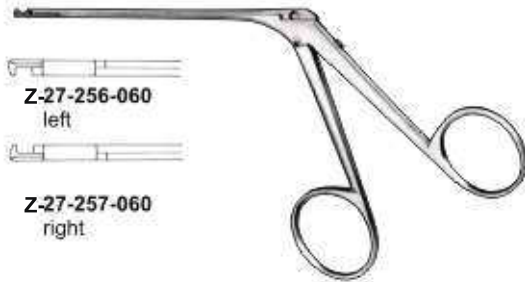
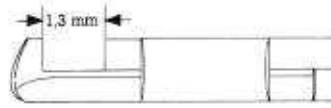

Z-27-256-060  
left

Z-27-257-060  
right

**HOUSE-DIETER**

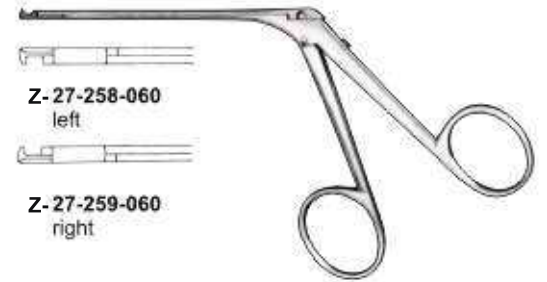

Z-27-258-060  
left

Z-27-259-060  
right

**HOUSE-DIETER**



**CITELLI**

- Z-27-260-060 6 cm, 2 1/2"
- Z-27-261-060 6 cm, 2 1/2"
- Z-27-262-060 6 cm, 2 1/2"



**BEYER**

- Z-27-263-090  
9 cm, 3 1/2"

# MICRO EAR FORCEPS, MASTOID RONGEURS



Mikro-Ohrzangchen, Ohr-Knochenstanzen  
 Micro Pinzas Auriculares, Pinzas Cortantes Para Huesos

Micro Pincas Auriculares, Ostetomes Emporte-pieces  
 Micro Pinze Auricolari, Pinze Osteotomi



**WULLSTEIN**

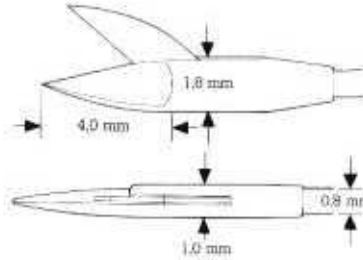
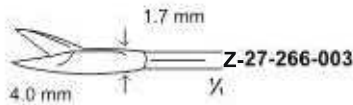
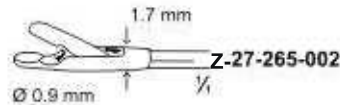
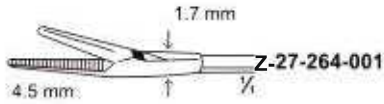

**Z-27-267-075**  
straight



**Z-27-268-075**  
curved up



**Z-27-269-075**  
right



**Z-27-270-075**  
left



**Z-27-271-001**  
Micro scissor  
straight, sharp / sharp



**BELLUCCI**  
**Z-27-272-002**  
Micro scissor  
curved up, blunt / blunt



**BELLUCCI**  
**Z-27-273-003**  
Micro scissor  
curved to the left,  
sharp / sharp



**BELLUCCI**  
**Z-27-274-004**  
Micro scissor  
curved to the right,  
sharp / sharp



**BELLUCCI**  
**Z-27-275-005**  
Micro scissor  
horizontal cutting

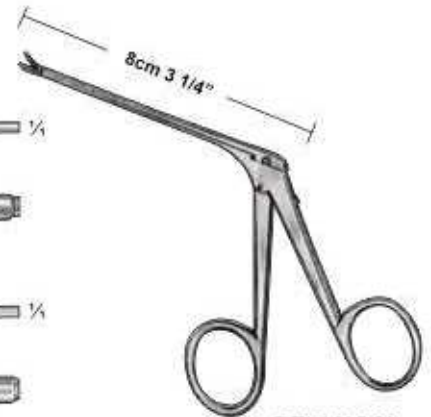

**BELLUCCI**  
8 cm, 3 1/4"

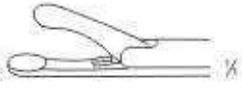

**Z-27-276-080**  
8 cm, 3 1/4"  
Straight

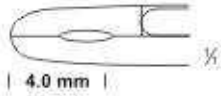

4.0 mm

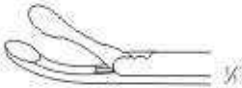
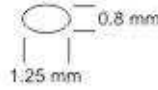

**Z-27-277-080**  
8 cm, 3 1/4"  
Curved right



**Z-27-279-080**  
8 cm, 3 1/4"  
Curved left

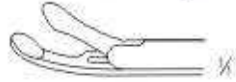

**Z-27-278-080**  
8 cm, 3 1/4"  
Curved up



**Z-27-279-080**  
8 cm, 3 1/4"  
Curved down



**CRURA-NIPPER**  
**Z-27-280-080**  
8 cm, 3 1/4"



**Z-27-282-080**  
8 cm, 3 1/4"  
0.8 x 3.5 mm

**Z-27-283-080**  
8 cm, 3 1/4"  
0.8 x 6.0 mm

**McGEE**  
**Z-27-281-080**  
8 cm, 3 1/4"



**TROELTSCH**  
Z-27-284-110  
11 cm, 4 1/2"



**TROELTSCH**  
Z-27-285-130  
13 cm, 5"



**TROELTSCH**  
Z-27-286-120  
12 cm, 5 3/4"



**LUCAE**  
Z-27-287-140  
14 cm, 5 1/2"



**JANSEN**  
Z-27-288-160  
16 cm, 6 1/4"



**TYDINGS TONSIL SEIZING FORCEPS**  
Z-27-289-184  
Two-prong jaws. With catch.  
18.4 cm, 7 1/4"



**TIVNEN TONSIL SEIZING FORCEPS**  
Z-27-290-216  
Guard on lock prevents over-riding of 3 x 3 prongs.  
21.6 cm, 8 1/2"



**KILLIAN**  
13 cm, 5 1/4"

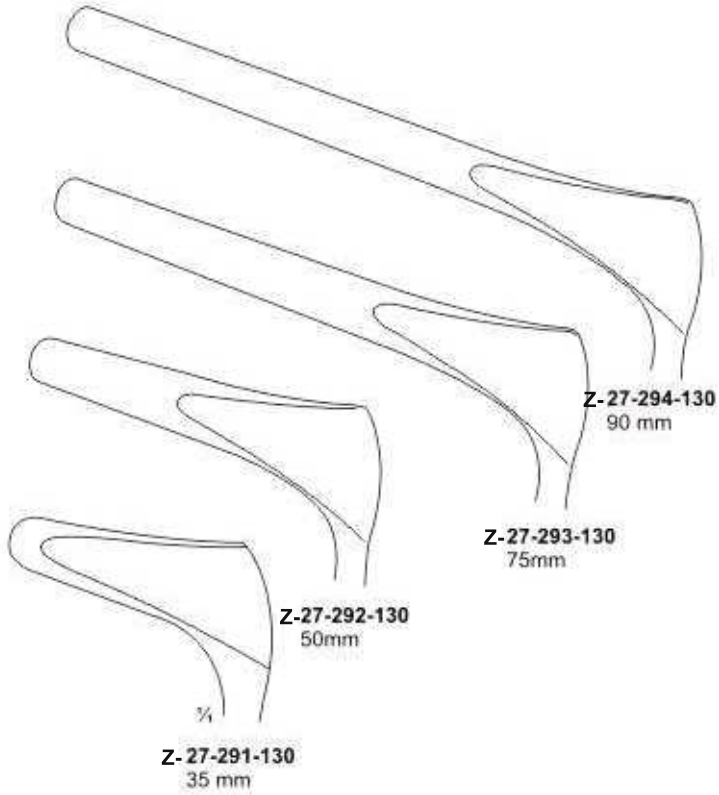

**MODIFIED WIEN**

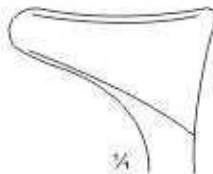

**Z-27-295-130**  
13.0 cm, 5 1/4"  
2.5 cm Tip

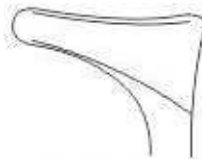

**Z-27-296-130**  
13.25 cm, 5 1/4"  
3 cm Tip



**COTTLE**  
Z-27-297-150  
15 cm, 6"



**COTTLE**  
15 cm, 6"

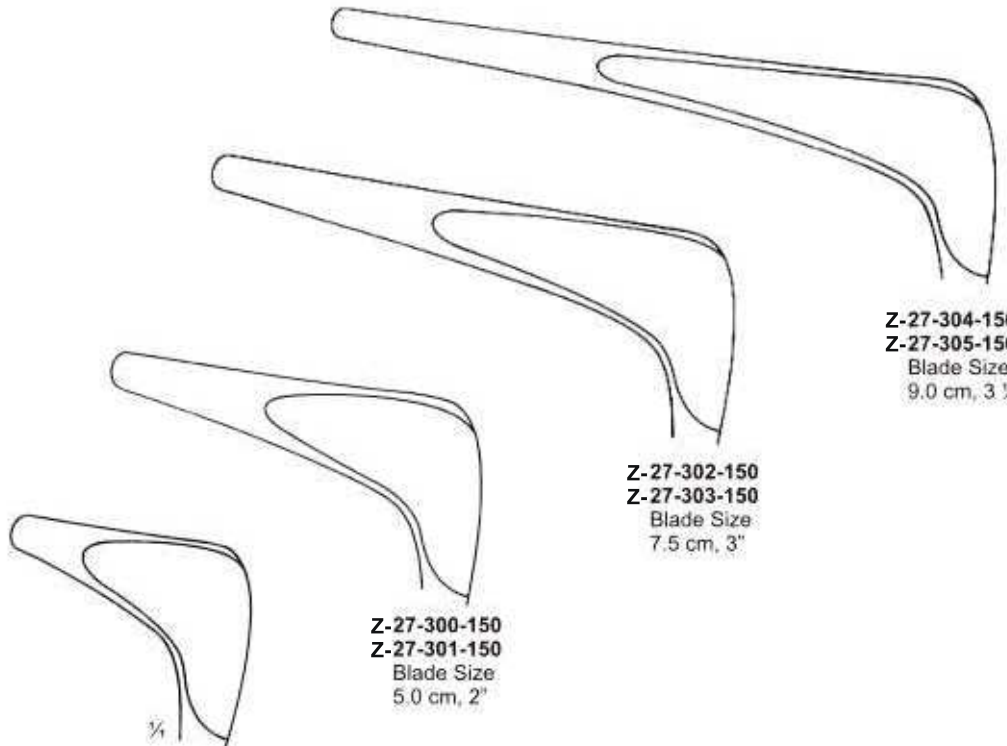

**Z-27-298-150**  
**Z-27-299-150**  
Blade Size  
3.5 cm, 1 ½"

**Z-27-300-150**  
**Z-27-301-150**  
Blade Size  
5.0 cm, 2"

**Z-27-302-150**  
**Z-27-303-150**  
Blade Size  
7.5 cm, 3"

**Z-27-304-150**  
**Z-27-305-150**  
Blade Size  
9.0 cm, 3 ½"

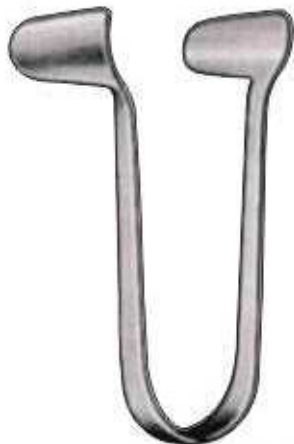

**THUDICHUM**  
(Golfsmith)



**Z-27-306-065**  
6.5 cm, 2 ½"

**Z-27-307-065**  
6.5 cm, 2 ½"

**Z-27-308-065**  
6.5 cm, 2 ½"



**VOLTOLINI**  
(Duplay)

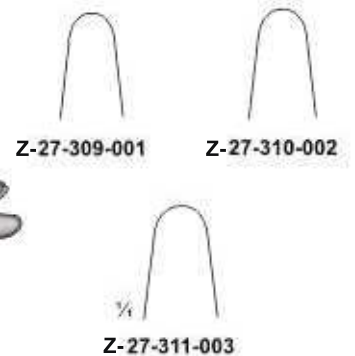

**Z-27-309-001**

**Z-27-310-002**

**Z-27-311-003**





Z-27-312-135  
13.5 cm, 5 1/2"

**TIECK-HALLE**



**BECKMANN**  
Z-27-313-130  
13 cm, 5"



**BECKMANN**  
15 cm, 6"



Z-27-314-150

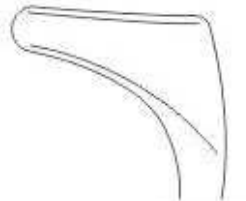

Z-27-315-150

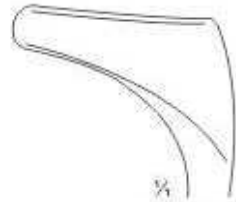

Z-27-316-150



**HARTMANN-HALLE**  
15 cm, 6"

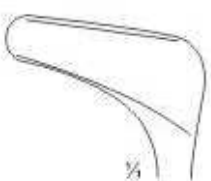

Z-27-317-150

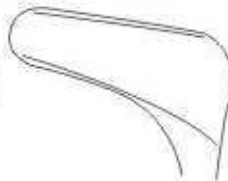

Z-27-318-150

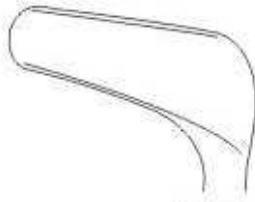

Z-27-319-150



**HARTMANN**  
15 cm, 6"

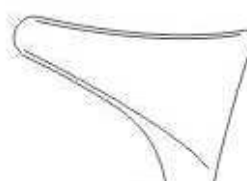

Z-27-320-150

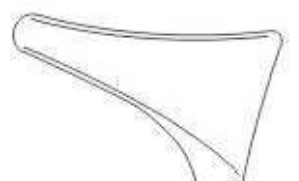

Z-27-321-150

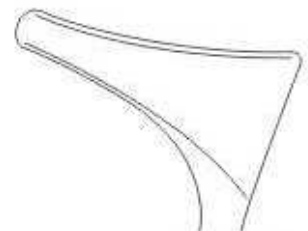

Z-27-322-150



**MODIFIED WIEN**  
14.5 cm, 5 3/4"

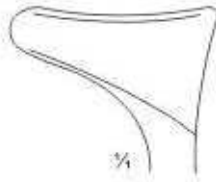

**Z-27-323-145**  
2.5 cm Tip

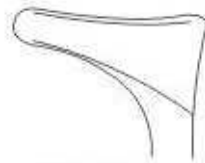

**Z-27-324-145**  
3 cm Tip



**VIENNA NASAL SPECULUM**

- Z-27-325-140 - Infant
- Z-27-326-140 - Child
- Z-27-327-140 - Adult
- 14 cm, 5 1/2"



**HALLE NASAL SPECULUM**

- Z-27-328-140 - Infant
- Z-27-329-140 - Adult
- 14 cm, 5 1/2"



**VIENNA NASAL SPECULUM**

- Z-27-330-140 - Adult
- 14 cm, 5 1/2"



**COTTLE SEPTAL SPECULUM**

- 27-331-150 15 cm, 6" Blade 2.8 cm
- 27-332-150 15 cm, 6" Blade 5 cm
- 27-333-150 15 cm, 6" Blade 7.5 cm
- 27-334-150 15 cm, 6" Blade 10 cm



**KILLIAN NASAL SPECULUM**

- Z-27-335-130 5 cm, 2" Small blade
- Z-27-336-130 7.5 cm, 3" Medium blade
- 13 cm, 5 1/4"

**SEPTUM FORCEPS**

Nasenpolyenzangen  
Pinzas Para Pólipos Nasaes

Pinces À Polypes Nasaux  
Pinze Per Polipi Nasali



**HARTMANN**  
Z-27-337-160  
16 cm, 6 1/4"  
Z-27-338-200  
20 cm, 8"



**HEYMANN-KNIGHT**  
Z-27-339-180  
18 cm, 7"



**LUBET-BARBON**  
Z-27-340-200  
20 cm, 8"



**KILLIAN**  
Z-27-341-170  
17 cm, 6 3/4"



**WESTMACOTT**



Z-27-342-200  
20 cm, 8"



Z-27-343-200  
20 cm, 8"

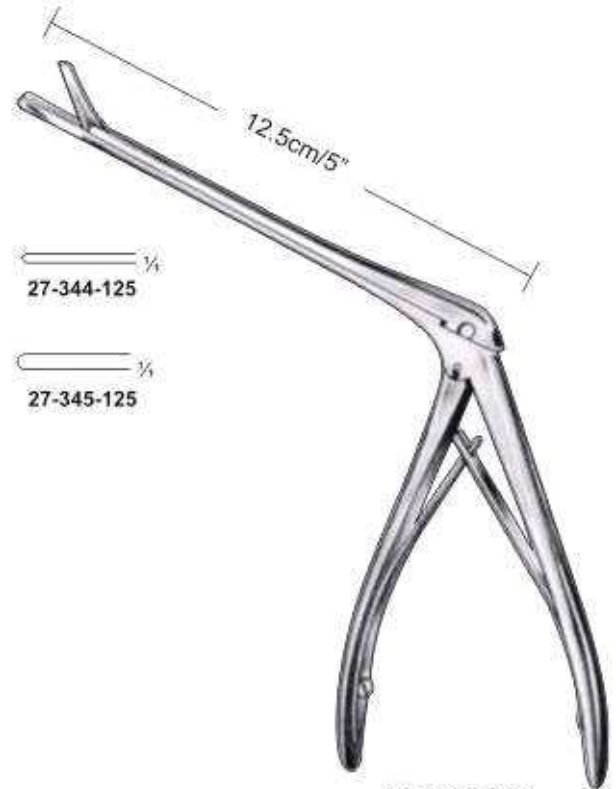

**STRUYCKEN**

27-344-125

27-345-125

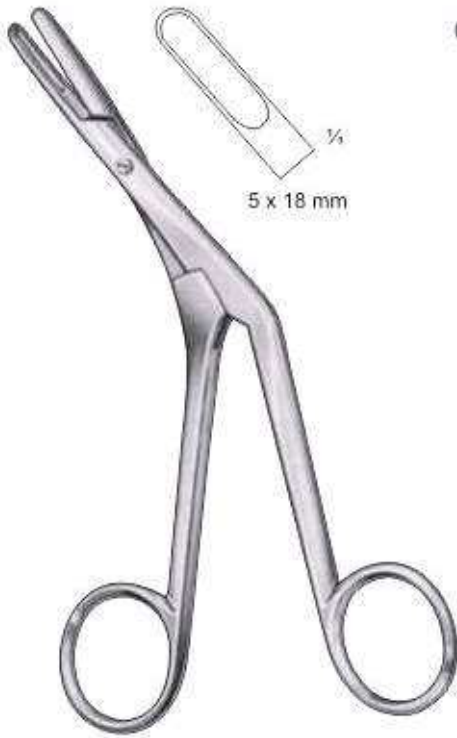

**GRAIG**  
Z-27-346-170  
18 cm, 7"

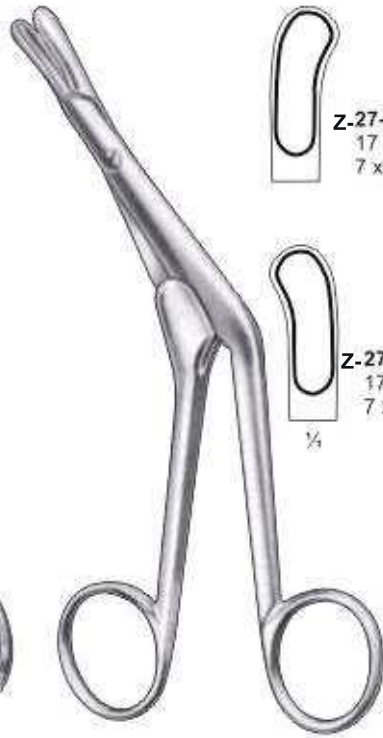

**GRAIG-DOMNICK**  
18 cm, 7"



**BRUENINGS**  
19 cm, 7 1/2"



**LUC**  
20 cm, 8"

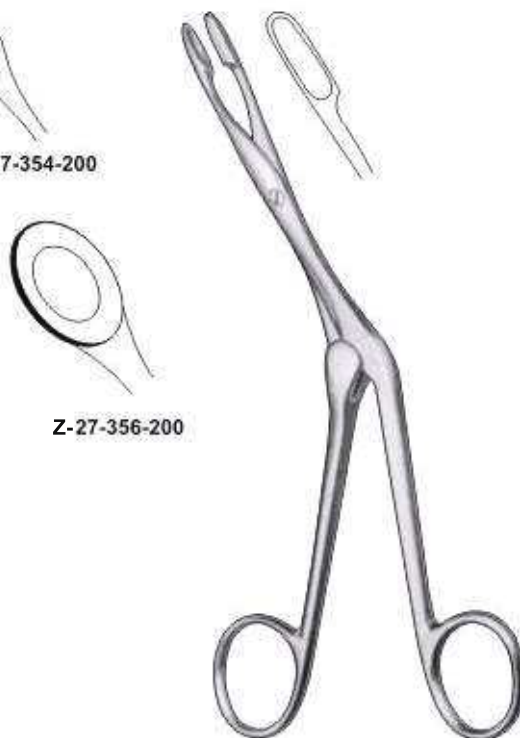

**KNIGHT**  
Z-27-357-180  
18 cm, 7"

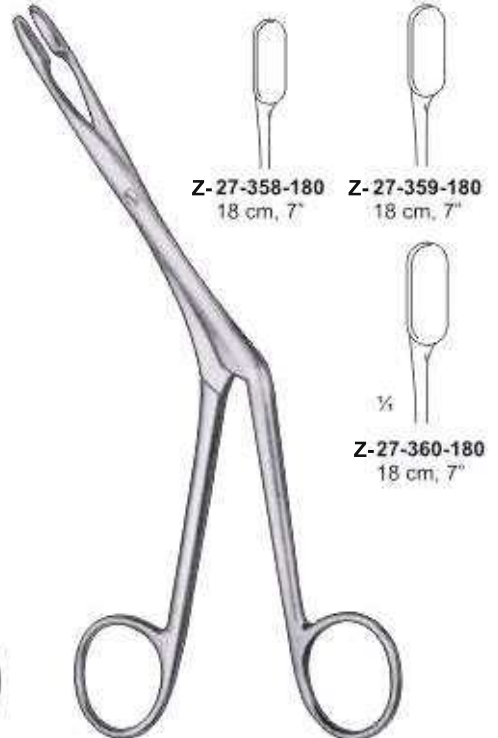

**HEYMANN**

# NASAL SCISSORS, NASAL TOMPON

Nasenscheren, Nasentamponinzetten  
Tijeras nasales, Septumzangen

Ciseaux nasaux, Pincesa à Pansements  
Forbici nasali, Pinces Pour La Cloison Nasale



**HEYMANN**  
**Z-27-361-200**  
Nasal Scissors  
20 cm, 8"

**KIRSTEIN**  
**Z-27-362-180**  
Nasal Scissors,  
blades serrated  
18 cm, 7"

**OLIVECRONE**  
**Z-27-363-225**  
Nasal Scissors,  
22.5 cm, 9"

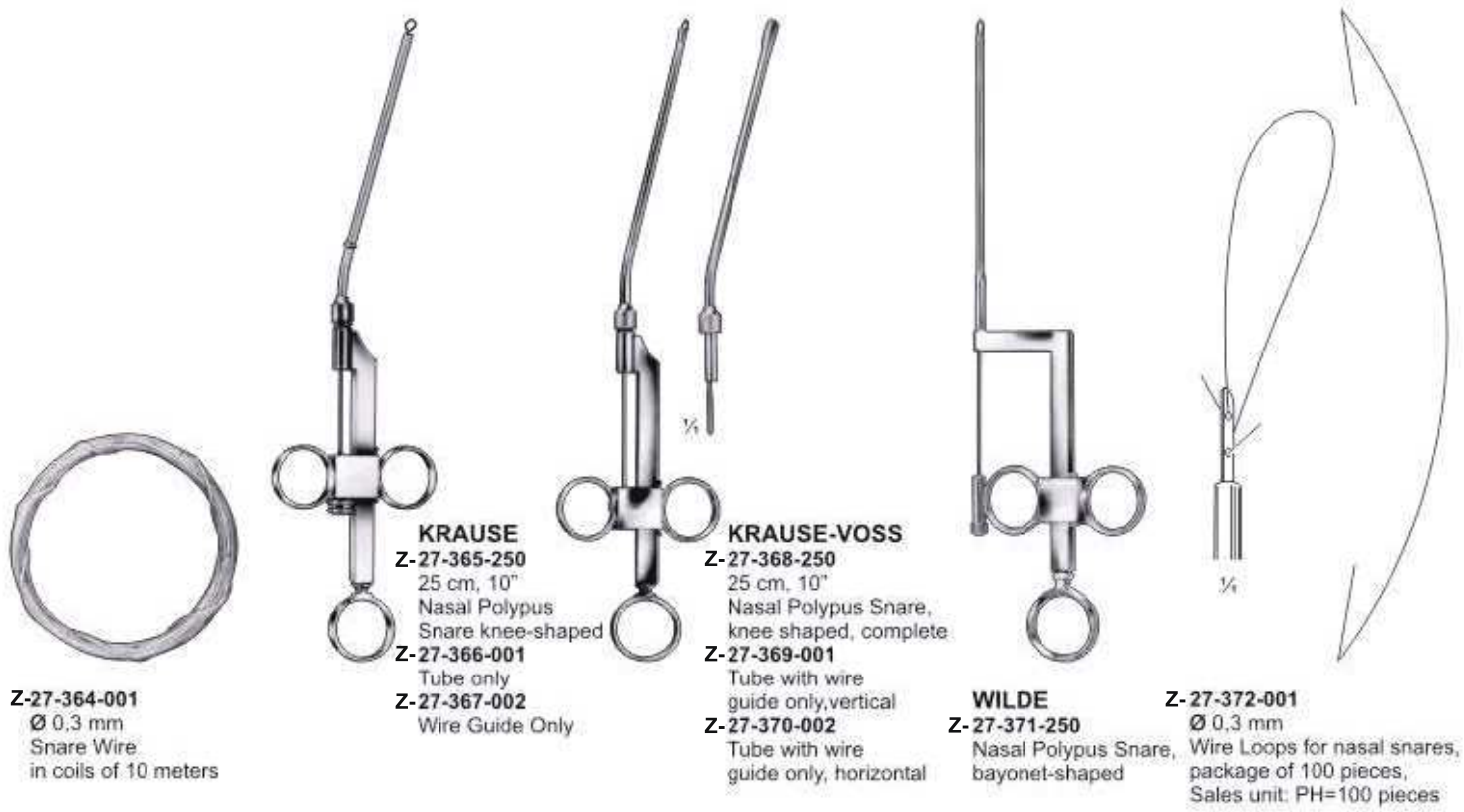

**Z-27-364-001**  
Ø 0.3 mm  
Snare Wire  
in coils of 10 meters

**KRAUSE**  
**Z-27-365-250**  
25 cm, 10"  
Nasal Polypus  
Snare knee-shaped  
**Z-27-366-001**  
Tube only  
**Z-27-367-002**  
Wire Guide Only

**KRAUSE-VOSS**  
**Z-27-368-250**  
25 cm, 10"  
Nasal Polypus Snare,  
knee shaped, complete  
**Z-27-369-001**  
Tube with wire  
guide only, vertical  
**Z-27-370-002**  
Tube with wire  
guide only, horizontal

**WILDE**  
**Z-27-371-250**  
Nasal Polypus Snare,  
bayonet-shaped

**Z-27-372-001**  
Ø 0.3 mm  
Wire Loops for nasal snares,  
package of 100 pieces,  
Sales unit: PH=100 pieces

# ALAR HOOKLETS, NASAL RETRACTORS



Nasenflügelhäkchen, Nasenhaken

Ganchitos Para Alas De Nariz, Separadores Nasales,

Crochets Pour Les Ailes Du Nez, Ecarteurs Nasaux

Uncini Per Le Pinne Nasali, Divaricatori Nasali



**COTTLE-NEIVERT**  
Z-27-373-200  
20 cm, 8"



**CONVERSE**  
Z-27-374-120  
12 cm, 5"



**MASING**  
Z-27-375-200  
20 cm, 8"



**COTTLE**  
Z-27-376-150  
15 cm, 6"



**COTTLE**  
Z-27-377-150  
15 cm, 6"



**JOSEPH**  
Z-27-378-150  
15 cm, 6"



**JOSEPH**  
15 cm, 6"

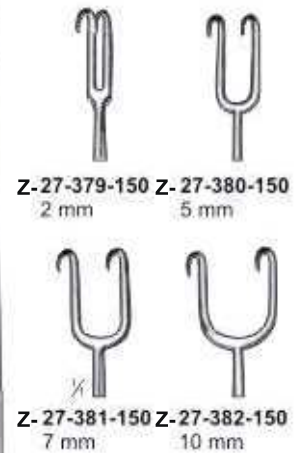

**JOSEPH**  
Z-27-383-150  
15 cm, 6"



**FOMON**  
Z-27-384-170  
17 cm, 6 3/4"



**LANGE**  
Z-27-385-220  
22 cm, 8 3/4"



**FOMON**  
Z-27-386-160  
16 cm, 6"



**FREER**  
Z-27-387-150  
15 cm, 6"



**COTTLE**  
14 cm, 5 1/2"



Z-27-388-140  
sharp/sharp



Z-27-389-140  
blunt/blunt



Z-27-390-140  
sharp/blunt



**COTTLE**  
Z-27-391-001



**KILNER**  
Z-27-392-001



**COTTLE**  
Z-27-393-140  
14 cm, 5 1/2"



**BALLENGER**

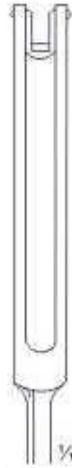

**Z-27-394-200**  
20 cm, 8"  
Swivel  
4mm



**BALLENGER**

**Z-27-395-200** 4 x 3 mm  
**Z-27-396-200** 5 x 4 mm  
**Z-27-397-200** 6 x 5 mm  
20 cm, 8"  
Swivel Knife,  
bayonet-shaped



3 mm



4 mm



5 mm



**JOSEPH**  
**Z-27-398-170**  
17 cm, 6 3/4"  
straight



**JOSEPH**  
**Z-27-399-170**  
17 cm, 6 3/4"  
bayonet shaped  
right curved



**JOSEPH**  
**Z-27-400-170**  
17 cm, 6 3/4"  
bayonet shaped  
left curved, nasal saws

SEPTUM CHISELS, SEPTUM GOUGES



Septummeißel, Septum-Hohlmeißel  
Cinceles Para Tabique Nasal, Gubias Para Tabique Nasal

Ciseaux-burins Pour La Cloison Nasale, Gouges Pour La Cloison Nasale  
Scalpello Per il Setto Nasale, Sgorbie Per il Setto Nasale



**FREER**  
Z-27-401-160  
16 cm, 6 1/4"  
4 mm wide  
Septum Chisel,  
straight



**FREER**  
Z-27-402-160  
16 cm, 6 1/4"  
4 mm wide  
Septum Chisel,  
curved



**FREER**  
Z-27-403-150  
15 cm, 6"  
6 mm wide  
Septum Gouge,  
straight



**BALLENGER**  
Z-27-404-155  
15.5 cm, 6"  
6 mm wide  
Septum Gouge



**KILLIAN-CLAUS**  
Z-27-405-170  
17 cm, 6 3/4"  
5 mm wide  
Septum Gouge



**KILLIAN**  
Z-27-406-170  
17 cm, 6 3/4"  
5 mm wide  
Septum Gouge



**MASING**  
Z-27-407-180  
18 cm, 7"



**MASING**  
Z-27-408-180  
18 cm, 7"



**MASING**  
Z-27-409-180  
18 cm, 7"



**MASING**  
Z-27-410-180  
18 cm, 7"



# SEPTUM CHISELS, SEPTUM GOUGES

Septummeißel, Septum-Hohlmeißel  
Cinceles Para Tabique Nasal, Gubias Para Tabique Nasal

Ciseaux-burins Pour La Cloison Nasale, Gouges Pour La Cloison Nasale  
Scalpello Per il Setto Nasale, Sgorbie Per il Setto Nasale



**SILVER**  
Z-27-411-180  
18 cm, 7"



**SILVER**  
Z-27-412-180  
18 cm, 7"



**SILVER**  
Z-27-413-180  
18 cm, 7"



**WALTER**  
Z-27-414-180  
chisel with notch,  
double guarded  
18 cm, 7"



**NEIVERT**  
Z-27-415-200  
20 cm, 8"



**ANDERSON-NEIVERT**  
Z-27-416-200  
20 cm, 8"



**ANDERSON-NEIVERT**  
Z-27-417-200  
20 cm, 8"



**CONVERSE**



**CONVERSE**  
Z-27-418-190  
19 cm, 7 1/2"



**CONVERSE**  
Z-27-419-190  
19 cm, 7 1/2"



27-420-140 5 mm  
27-421-140 7 mm  
27-422-140 9 mm



**GILLIES**  
Osteotome  
14 cm, 5 1/2"

Osteotome  
 Osteótomos



**COTTLE.**  
**Z-27-423-180**  
 fishtail osteotomes  
 with protected ends  
 double guarded  
 18 cm, 7"

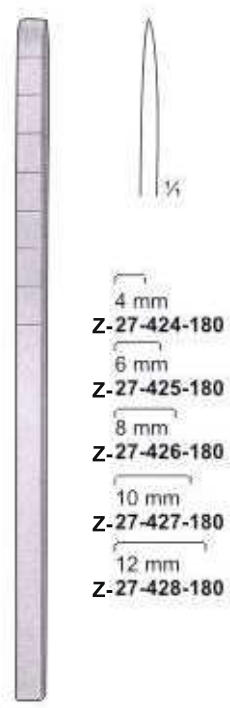

**COTTLE**  
 osteotomes with depth  
 markings 4 mm, 6 mm,  
 8 mm, 10 mm, 12 mm,  
 18 cm, 7"

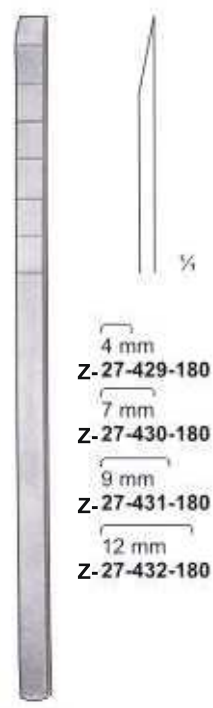

**COTTLE**  
 chisel with depth  
 markings  
 18 cm, 7"



**COTTLE**  
**Z-27-433-180**  
 osteotome, curved,  
 depth markings:  
 18 cm, 7"

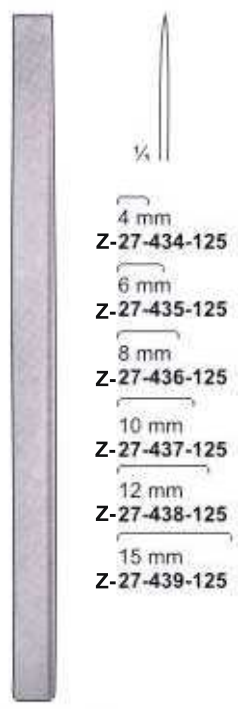

**LAMBOTTE**  
 4 mm, 6 mm, 8 mm,  
 10 mm, 12 mm, 15 mm  
 Osteotome  
 12.5 cm, 5"

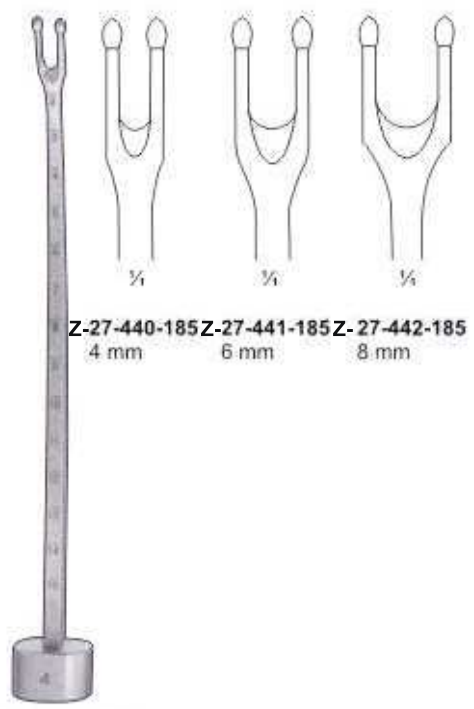

**OSTEOTOMES**  
**for septum**  
 18.5 cm, 7 1/4 "

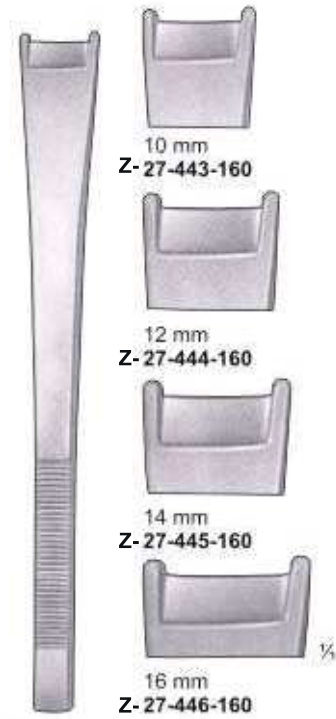

**CINELLI**  
 osteotome, double  
 guarded, straight  
 16 cm, 6 1/4 "



**FOMON**  
**Z-27-447-170** 5 mm  
**Z-27-448-170** 8 mm  
 17 cm, 6 3/4 "

# SEPTUM ELEVATORS, PERIOSTEAL ELEVATORS

Septum elevatorien, Periostelevatorien

Élévateurs Pour La Cloison Nasale, Élévateurs Pour Le Périoste

Elceadores Para Tabique Nasal, Lae gras Para Periostio Elevatori Per Il Setto Nasale, Elevatori Per il Periosto



**FREER**  
Z-27-449-155  
15.5 cm, 6 1/4"  
Mucous Knife



**BRUNINGS**  
Z-27-450-155  
15.5 cm, 6 1/4"  
Septatome



**HALLE**  
Z-27-451-180 18 cm, 7"  
3,3 mm  
Elevator blunt

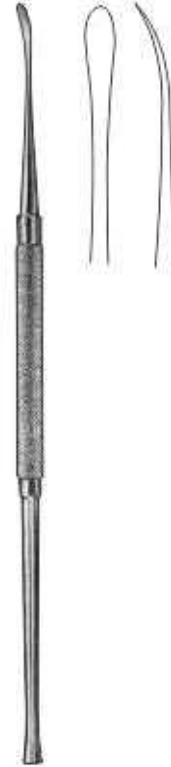

**FREER**  
Z-27-452-190 19 cm, 7 1/2"  
4 mm  
Respiratory sharp



**FREER**  
Z-27-453-190 19 cm, 7 1/2"  
4 mm  
Respiratory sharp



**FREER**  
Z-27-454-190 19 cm, 7 1/2"  
4 mm  
Elevator curved



**FREER**  
Z-27-455-175  
4 mm  
Raspatory Sharp  
17.5 cm, 7"

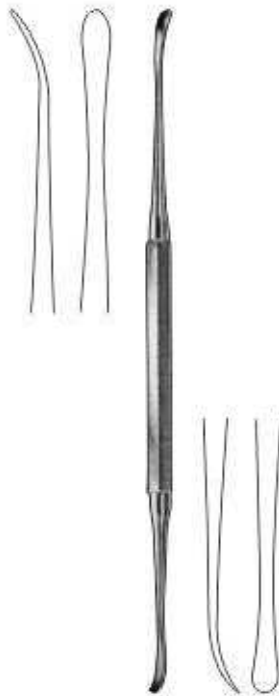

**FREER**  
Z-27-456-180  
18 cm, 7"  
Elevator, sharp / blunt



**FREER-YASARGIL**  
Z-27-457-180  
18 cm, 7"  
Dissector, sharp



**KILLIAN**  
Z-27-458-180  
18 cm, 7"  
Elevator, sharp / blunt

## SEPTUM ELEVATORS, PERIOSTEAL ELEVATORS

Septumelevatorien, Periostelevatorien

Élévateurs Pour La Cloison Nasale, Élévateurs Pour Le Périoste

Elceadores Para Tabique Nasal, Lae gras Para Periostio Elevatori Per Il Setto Nasale, Elevatori Per il Periosto



**HILL**  
Z-27-459-220  
22 cm, 8 3/4"  
Elevator, semi-sharp / blunt



**MACDONALD**  
Z-27-460-190  
19 cm, 7 1/2"  
Dissector, blunt / blunt



**WATRON-CHEYNE  
RASPATORY**  
19 cm, 7 1/2"

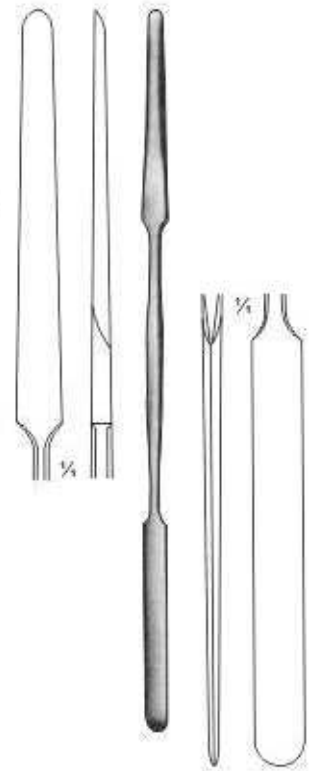
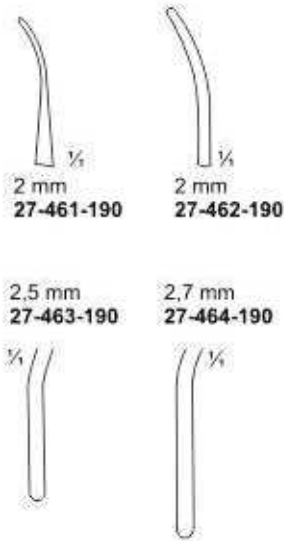

**KILLIAN**  
Z-27-465-185  
18.5 cm, 7 1/4"  
Elevator sharp / blunt



**Negus**  
Z-27-466-210  
6 mm  
suction dissector  
21 cm, 8 1/4"  
Ø 6 mm  
Olive



**Negus**  
Z-27-467-215  
21.5 cm, 8 1/4"  
6 mm  
suction dissector,  
insulated  
Ø 6 mm  
Olive  
0.4 mm



**HOWASTH**  
Z-27-468-215  
21.5 cm, 8 1/4"  
Elevator

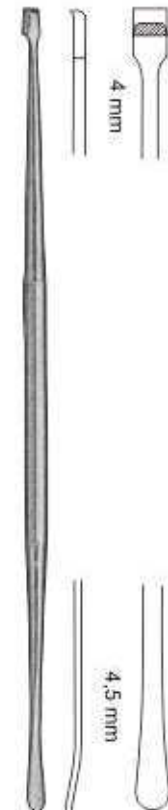

**FREER**  
Z-27-469-180  
separator &  
elevator  
180 cm, 7"  
4.5 mm

**SEPTUM, PERIOSTEAL ELEVATORS**

Septumelevatorien, Periostelevatorien

Elévateurs Pour La Cloison Nasale, Elévateurs Pour Le Périoste

Elceadores Para Tabique Nasal, Laegras Para Periostio

Elevatori Per Il Setto Nasale, Elevatori Per il Periosto



**ST CLAIR THOMPSON**  
 Z-27-470-160  
 sharp / blunt  
 Raspatory, periosteal elevator  
 16 cm, 6 1/4"



**FREER**  
 Z-27-471-160  
 sharp / blunt  
 Septum chisel,  
 straight  
 16 cm, 6 1/4"



**FREER**  
 Z-27-472-160  
 sharp / blunt  
 Septum chisel,  
 Curved  
 16 cm, 6 1/4"



**PENNINGTON**  
 Raspatory  
 Z-27-473-210  
 21 cm, 8 1/4"



**COTTLE**  
 Z-27-474-200  
 Elevator, double-  
 ended, graduated  
 20 cm, 8"



**COTTLE**  
 Z-27-475-200  
 Elevator, double-  
 ended, graduated  
 20 cm, 8"

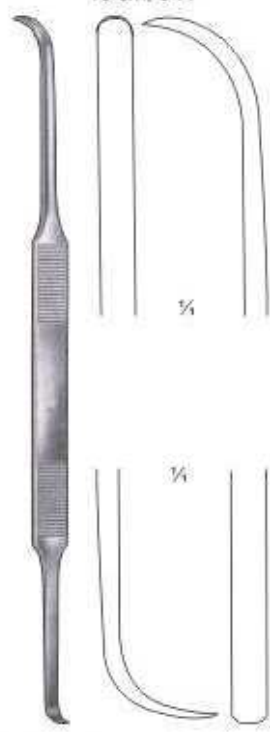

**COTTLE**  
 Z-27-476-200  
 Elevator, double-  
 ended, for tunneling  
 20 cm, 8"



**COTTLE**  
 Z-27-477-200  
 Periosteal Elevator,  
 curved, sharp  
 20 cm, 8"



**HALLE**  
 Z-27-478-180  
 Elevator, blunt  
 18 cm, 7"

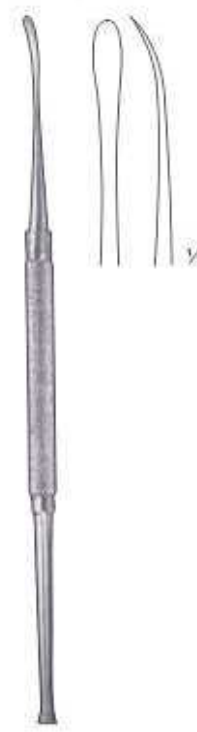

**FREER**  
 Z-27-479-180  
 Raspatory, sharp  
 18 cm, 7"

SEPTUM, PERIOSTEAL ELEVATORS



Septum elevatorien, Periostelevatorien  
 Elceadores Para Tabique Nasal, Lae gras Para Periostio

Elévateurs Pour La Cloison Nasale, Elévateurs Pour Le Périoste  
 Elevatori Per Il Setto Nasale, Elevatori Per il Periosto

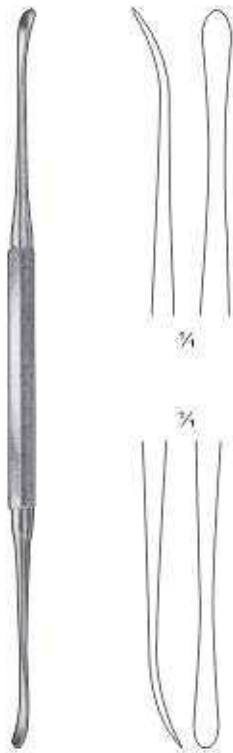

**FREER**  
**Z-27-480-180**  
 Elevator sharp blunt  
 18 cm, 7"

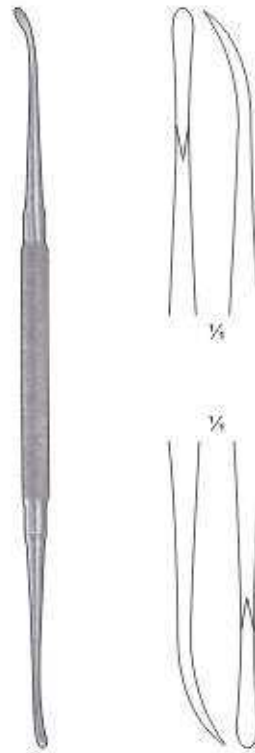

**FREER YASARGIL**  
**Z-27-481-180**  
 Dissector sharp  
 18 cm, 7"

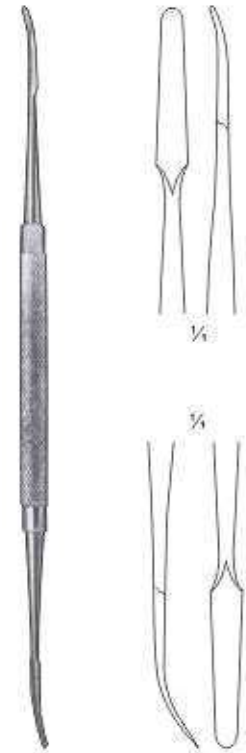

**FREER YASARGIL**  
**Z-27-482-180**  
 Dissector sharp/blunt  
 18 cm, 7"



**HOWARTH**  
**Z-27-483-215**  
 Elevator  
 21.5 cm 8 1/2"

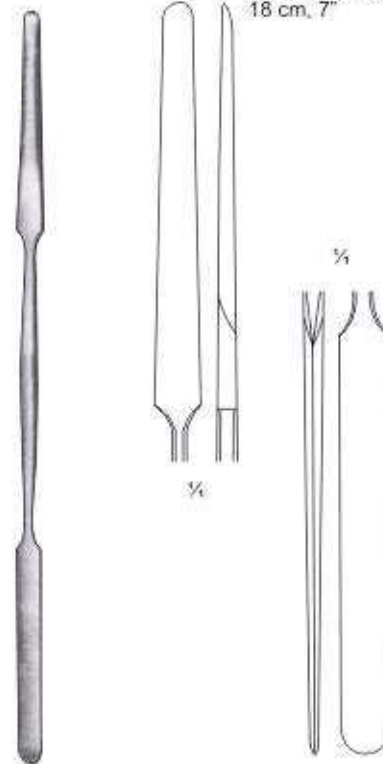

**KILLIAN**  
**Z-27-484-215**  
 Elevator sharp/blunt  
 21.5 cm 8 1/2"

Rhinoplastik-Messer, Septummesser, Schwingmesser  
Cuchillos Para Rinoplástica, Cuchillos Para Tabique Nasal

Couteaux Pour Plastic Du Nez, Bistouris Pour La Cloison Nasale  
Bisturi Per Plastica Nasale, Bisturi Per Il Setto Nasale



**FREER**  
Elevator, blunt  
Z-27-485-190  
19cm, 7 1/2"



**FREER**  
Z-27-486-185  
Knife curved  
18.5 cm, 7 1/4"



**FREER**  
Z-27-487-185  
Elevator sharp  
18.5 cm, 7 1/4"



**SAALFELD**  
Z-27-488-180  
18 cm, 7"  
Milium Knife and  
Comedone Extractor



**HERBA**  
Z-27-489-180  
18 cm, 7"  
Milium Knife and  
Comedone Extractor



**HERBA**  
Z-27-490-115  
11.5 cm, 4 1/2"  
Milium Knife and  
Comedone Extractor

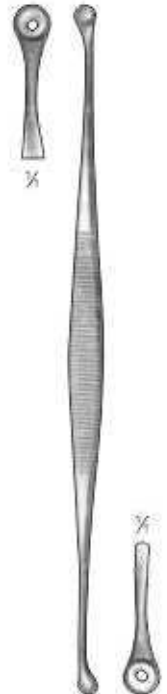

**UNNA**  
Z-27-491-140  
14 cm, 5 1/2"  
Comedone Extractor,  
double-ended



**Z-27-492-190**  
19 cm, 7 1/2"  
Double Action  
5 x 15mm tip

**JANSEN-MIDDLETON**

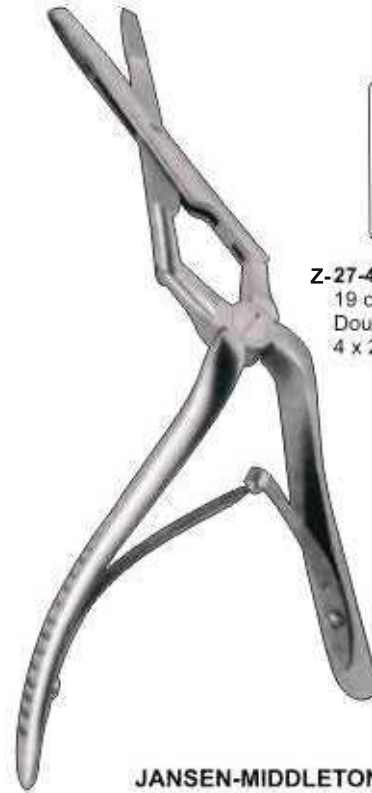

**Z-27-493-190**  
19 cm, 7 1/2"  
Double Action  
4 x 20 mm tip

**JANSEN-MIDDLETON**



**KILLIAN**  
**Z-27-494-200**  
20 cm, 8"



# GLABELLA RASPS, NASAL RASPS

Glabellaraspein Nasenraspein

Escofinas Para Glabella, Escofinas Nasaes, Escofinas Nasaes

Râpes Pour La Glabelle, Râpes Nasaes, Râpes Nasaes

Raspe Per Glabella, Raspe Nasali, Raspe Nasali

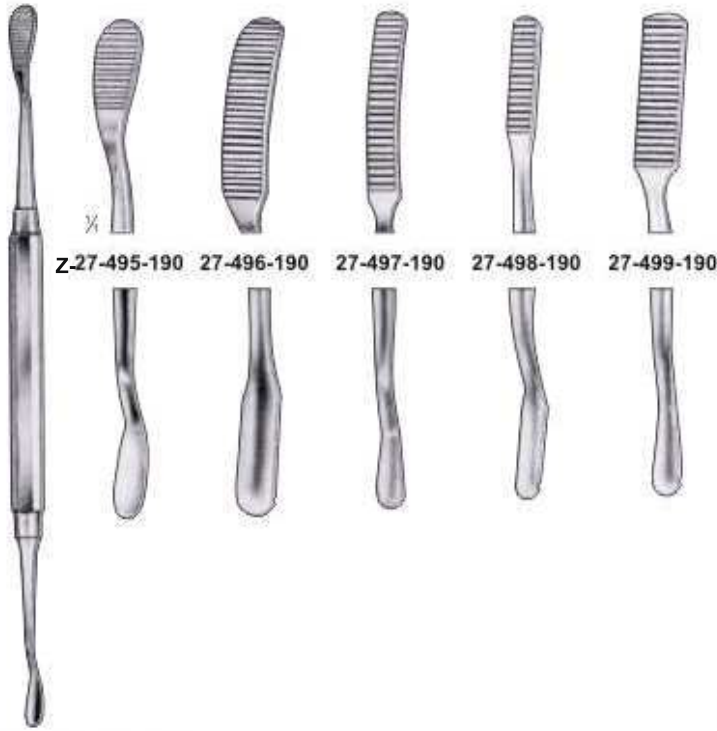

Z-27-495-190 27-496-190 27-497-190 27-498-190 27-499-190

**MILLER-COLBURN**  
19 cm, 7 1/2"



**MILLER**  
Rasps, set to cut on down stroke, fine teeth  
8 mm  
Rasps, set to cut on down stroke, coarse teeth  
18.5 cm, 7 1/4"



**AUFRICHT** 9 mm  
Rasps, set to cut on up stroke  
9 mm  
Rasps, set to cut on down stroke  
18.5 cm, 7 1/4"



**LEWIS**  
18 cm, 7"

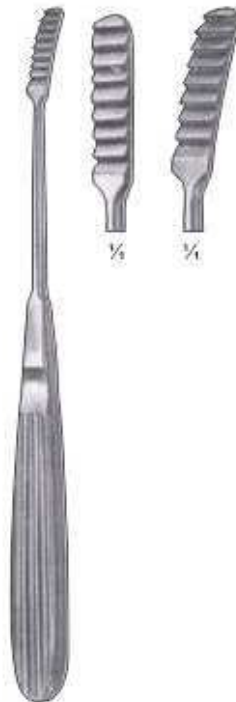

**MALTZ**  
Z-27-505-180  
straight  
Rasp  
18 cm, 7"



**MALTZ**  
Z-27-506-180  
Rasp, teeth set to cut on down stroke  
18 cm, 7"

**GLABELLA RASPS, NASAL RASPS**



Glbellaraspeln Nasenraspeln Escofinas Para Glabella, Râpes Pour La Glabelle, Râpes Nasaes, Râpes Nasaes  
 Escofinas Nasaes, Escofinas Nasaes Raspe Per Glabella, Raspe Nasali, Raspe Nasali

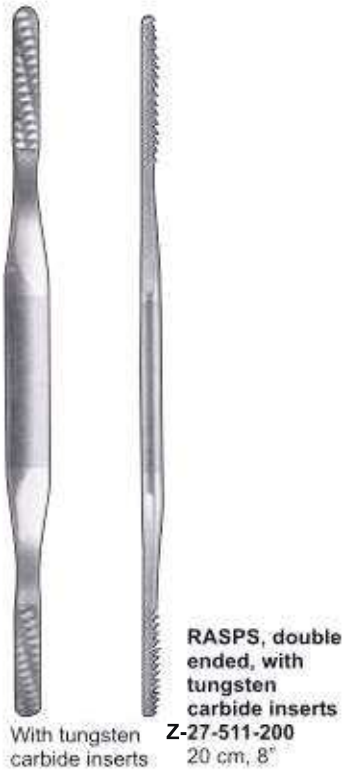
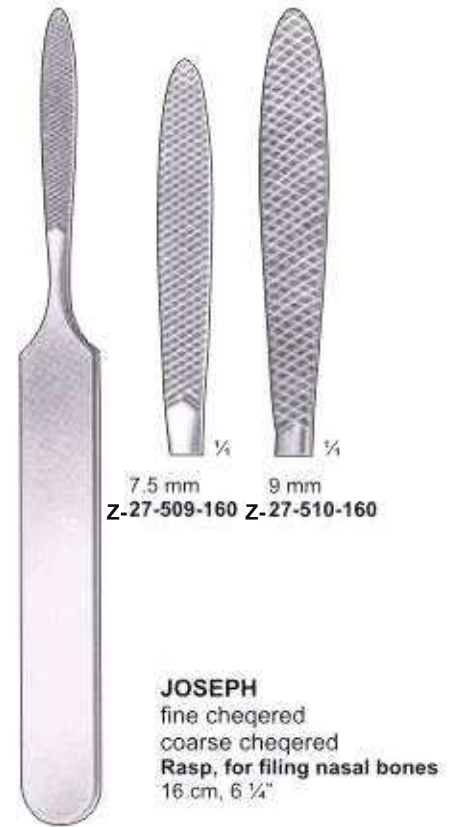
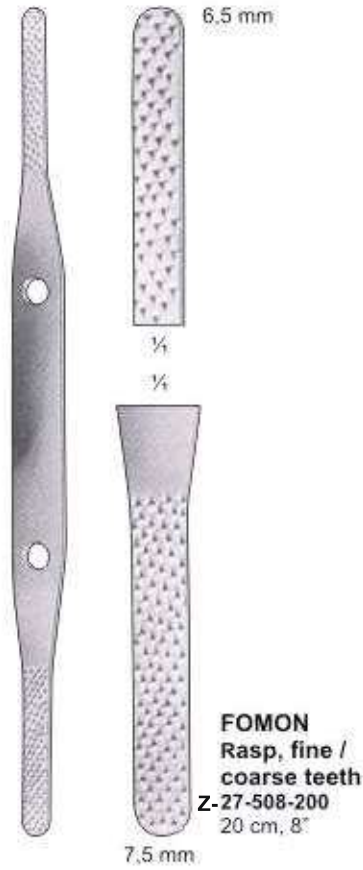
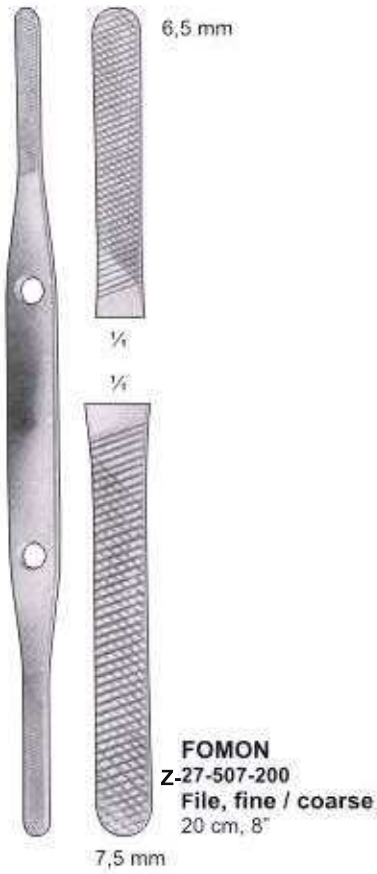

# SPHENOID BONE PUNCHES

Pinzas Sacabocadas Para Esfenoides,  
Pinzas Sacabocadas Para Seno Maxilar

Pinze Taglienti Per Seno Sfenoidale,  
Pinze Taglienti Per Seno Mascellare

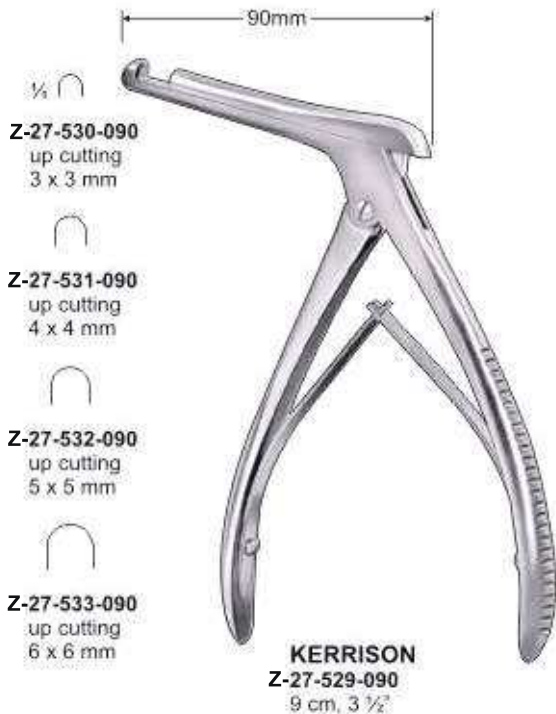
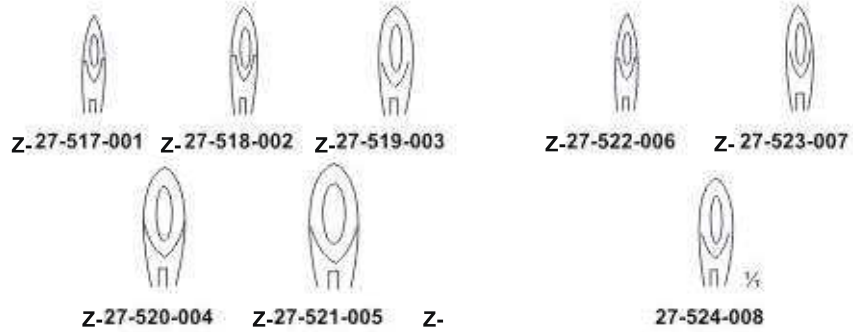

Tonsillenzangen  
 Pinzas Para Amígdalas

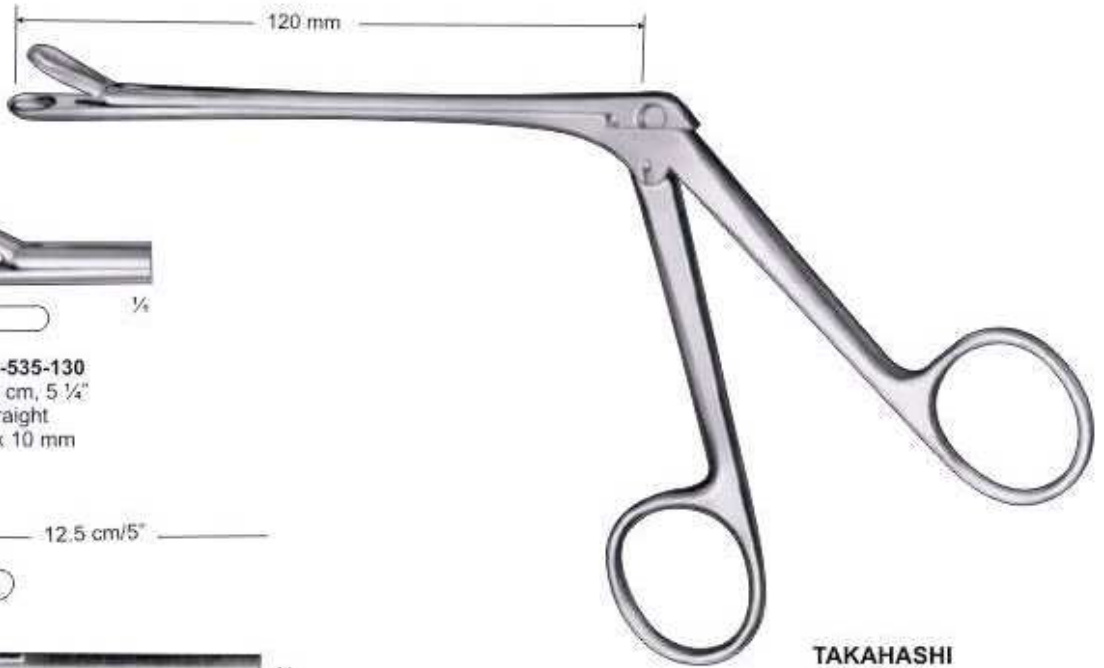

**TAKAHASHI**  
 19 cm, 7 1/2"



**Z-27-535-130**  
 13 cm, 5 1/4"  
 Straight  
 5 x 10 mm

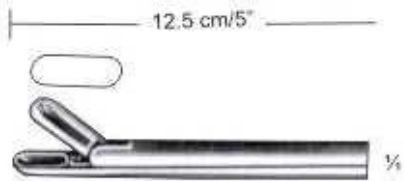

**WATSON-WILLIAMS**  
**Z-27-536-125**

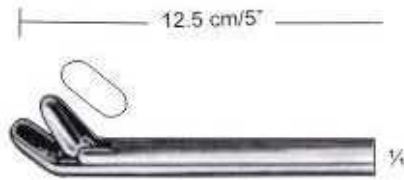

**WATSON-WILLIAMS**  
**Z-27-537-125**



**GRUENWALD-HENKE**  
 Nasal Cutting Forceps



**Z-27-538-125**



**Z-27-539-125**



**Z-27-540-125**





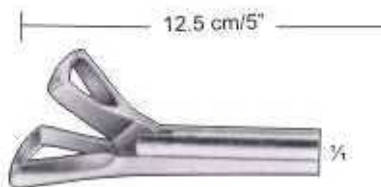

**Z-27-541-125**

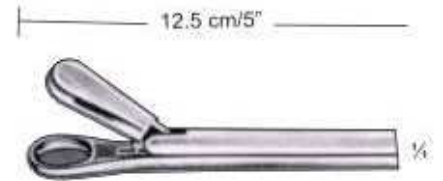

**SCHMEDEN**  
 Nasal Cutting Forceps



**WATSON-WILLIAMS**  
**Z-27-542-125**

-  27-543-125
-  27-544-125
-  27-545-125
-  27-546-125

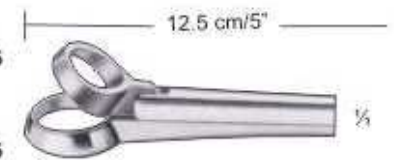

**HARTMANN**  
 Nasal Cutting Forceps

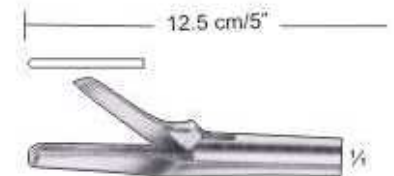

**STRUYCKEN**  
 Nasal Cutting Forceps  
**Z-27-547-125**

# CARTILAGE CRUSHER, SEPTUM FORCEPS

Knorpelquetsche, Septumzangen  
Machacadora, Septumrichtzangen

Pinces-gouge à Cartilage, Pincas Pour La Cloison Nasale,  
Torchio Per Cartilagine, Pinze Per il Setto Nasale



**ASCH**  
27-548-230  
23 cm, 9"

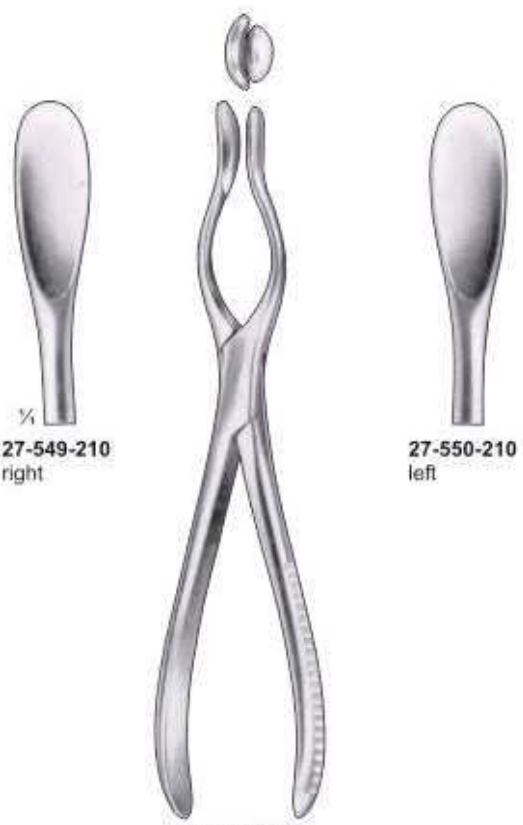

**WALSHAM**  
21 cm, 8 1/4"



**BOIES**  
27-551-180  
18 cm, 7"



Cottle Bone



**27-552-001**  
Cottle Cartilage Crusher



**FERGUSSON**

- Z-27-553-180 Ø 2.0 mm, 6 F.G.
  - Z-27-554-180 Ø 2.5 mm, 7-8 F.G.
  - Z-27-555-180 Ø 3.0 mm, 9 F.G.
  - Z-27-556-180 Ø 4.0 mm, 12 F.G.
  - Z-27-557-180 Ø 5.0 mm, 15 F.G.
- 18 cm, 7"



**PLESTER**

- Z-27-558-195 Ø 1.5 mm, 4-5 F.G.
  - Z-27-559-195 Ø 2.0 mm, 6 F.G.
  - Z-27-560-195 Ø 2.5 mm, 7-8 F.G.
  - Z-27-561-195 Ø 3.0 mm, 9 F.G.
- Z-19.5 cm, 8"



**NASAL SUCTION TUBES**

- Z-27-562-160 Ø 5 mm
- 16 cm, 6 1/4"



**FRAZIER**

- Z-27-563-180 Ø 3 mm
  - Z-27-564-180 Ø 5 mm
- 18 cm, 7"



**FRAZIER**



- Z-27-565-175
- Outside 4,5 diam.  
17,5 cm, 7"



- Z-27-566-175
- Outside 5,5 diam.  
17,5 cm, 7"



2mm Ø  
Z-27-567-001

3mm Ø  
Z-27-568-002

4mm Ø  
Z-27-569-003

5mm Ø  
Z-27-570-004

6mm Ø  
Z-27-571-005

7mm Ø  
Z-27-572-006

**KEYES**  
Z-27-567-001 — 27-572-006  
Dermal Punches

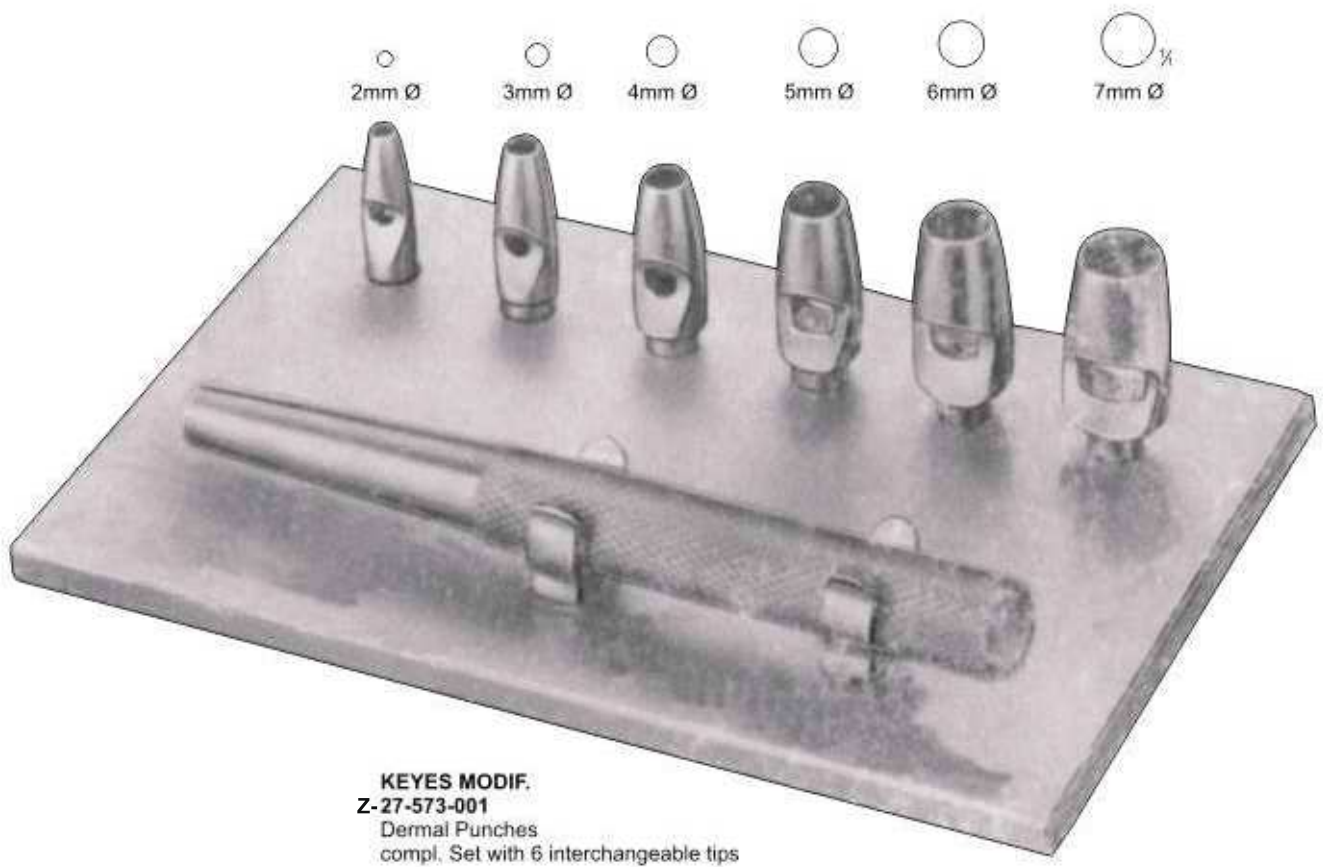

**KEYES MODIF.**  
Z-27-573-001  
Dermal Punches  
compl. Set with 6 interchangeable tips



**BOETTCHER**  
Tonsil scissors  
27-574-180 18 cm, 7"



**DEAN**  
Tonsil scissors, with angled,  
serrated blades  
Z-27-575-170 17 cm, 6 3/4"

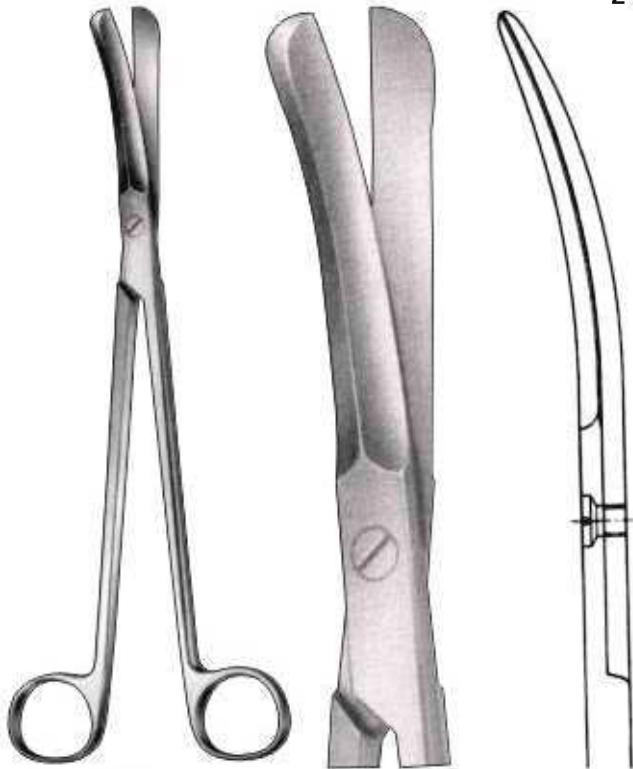

**GOOD**  
Tonsil scissors  
Z-27-576-195 19.5 cm, 7 3/4"

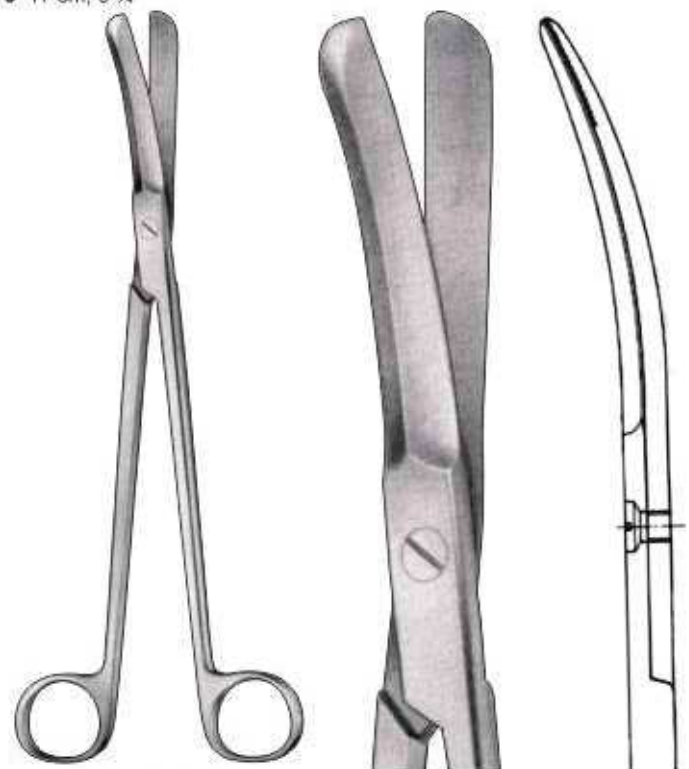

**SCHWECKENDIEK**  
Tonsil scissors  
Z-27-577-195 19.5 cm, 7 3/4"





**TOBOLD**  
Z-27-578-145  
14.5 cm, 5 3/4"



**27-579-145**  
14.5 cm, 5 1/2"  
serrated 28 mm

**27-580-145**  
14.5 cm, 5 1/2"  
serrated 32 mm

**WEIDER**



**TONGUE DEPRESSOR**  
Z-27-581-145  
14.5 cm, 5 3/4"



**TONGUE DEPRESSOR**  
Z-27-582-145  
14.5 cm, 5 3/4"



**BUCHWALD**  
Z-27-583-180  
Tongue Depressor  
18 cm, 7"



**BRUENINGS**  
Z-27-584-190  
Tongue Depressor  
19 cm, 7 1/2"



**FRENZEL**  
Z-27-585-165  
Tongue Depressor  
16.5 cm, 6 1/2"



**M-SCHMIDT**  
Z-27-586-190  
Tongue Depressor  
19 cm, 7 1/2"  
hollow

# MOUTH GAG, LIP & CHEEK RETRACTORS

Mundsperrer, Lippen- u. Wangenhalter  
Abrebocas, Separadores Para Labios y Mejillas

Ouvre-bouche, Ecarteurs Des Lèvres et Joues  
Apribocca, Separatori Per Labbra e Guancia



**FERGUSON-ACKLAND**  
Z-27-587-145  
14.5 cm, 5 3/4"



**DENHARDT**  
Z-27-588-125  
12.5 cm, 5"  
Mouth Gag  
with silicon inserts,  
interchangeable



**ROSER-KONIG**  
Z-27-589-160  
16 cm, 6 1/4"  
Mouth Gag



**DOYEN-COLLIN**  
Z-27-590-120 12 cm, 5"  
Z-27-591-140 14 cm, 5 1/2"  
Mout Gag



**MOLT**  
Z-27-592-110  
Z-11 cm, 4 1/2"

Mundsperrerr, Lippen- u. Wangenhalter  
Abre bocas, Separadores Para Labios y Mejillas

Ouvre-bouche, Ecarteurs Des Lèvres et Joues  
Apribocca, Separatori Per Labbra e Guancia



**HEISTER**  
Z-27-593-130 13 cm, 5"  
Mouth Gag



**WHITEHEAD**  
Z-27-594-090 9 cm, 3 1/2"  
Z-27-595-110 11 cm, 4 1/4"  
Z-27-596-130 13 cm, 5"  
Z-27-597-150 15 cm, 6"  
Mouth Gag



**WHITEHEAD**  
Z-27-598-110 11 cm, 4 1/4"  
Z-27-599-130 13 cm, 5"  
Z-27-600-150 15 cm, 6"  
Mouth Gag  
with tongue depressor



**WHITEHEAD-JENNINGS**  
Z-27-601-090 9 cm, 3 1/2"  
Z-27-602-110 11 cm, 4 1/4"  
Z-27-603-130 13 cm, 5"  
Z-27-604-150 15 cm, 6"  
Mouth Gag



**DAVIS-BOYLE**  
Z-27-605-001  
Complete Set  
Double Bite-Lift Side  
Gag only left side



27-606-001



Z-27-607-002



Z-27-608-003



Z-27-609-004



Z-27-610-005

**DAVIS-BOYLE**  
Z-27-606-001 20 X 25mm  
Z-27-607-002 22 X 60mm  
Z-27-608-003 25 X 75mm  
Z-27-609-004 25 X 90mm  
Z-27-610-005 27 X 105mm  
Tongue Blades only.



27-611-001  
Gag Only

**MCIVOR**



Z-27-612-001  
Complete Set  
with 3 Blades

**MCIVOR**  
blade



**MODELL WURZBURG**  
Z-27-613-001 66 x 28 mm  
Z-27-614-002 75 x 32 mm  
Z-27-615-003 83 x 34 mm  
Z-27-616-004 93 x 37 mm  
Z-27-617-005 100 x 38 mm



- RUSSEL-DAVIS**
- Z-27-618-001 29 x 67 mm
  - Z-27-619-002 33 x 75 mm
  - Z-27-620-003 38 x 85 mm
  - Z-27-621-004 40 x 92 mm
  - Z-27-622-005 46 x 100 mm



- RUSSEL-DAVIS**
- Z-27-623-001 18 x 57 mm
  - Z-27-624-002 22 x 67 mm
  - Z-27-625-003 25 x 75 mm



Z-27-626-001  
Gag only

**KILNER-DOUGHTY**  
Z-27-627-002  
complete



1/2  
Z-27-628-003



1/2  
Z-27-629-004



Z-27-630-005



1/2  
Z-27-631-006

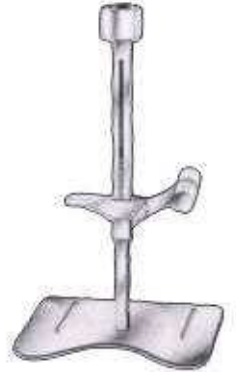

**NEGUS**  
Z-27-632-001  
Chest support for Mouth Gag



Z-27-635-003  
55 x 25 mm



Z-27-636-004  
60 x 27 mm



Z-27-637-005  
70 x 30 mm

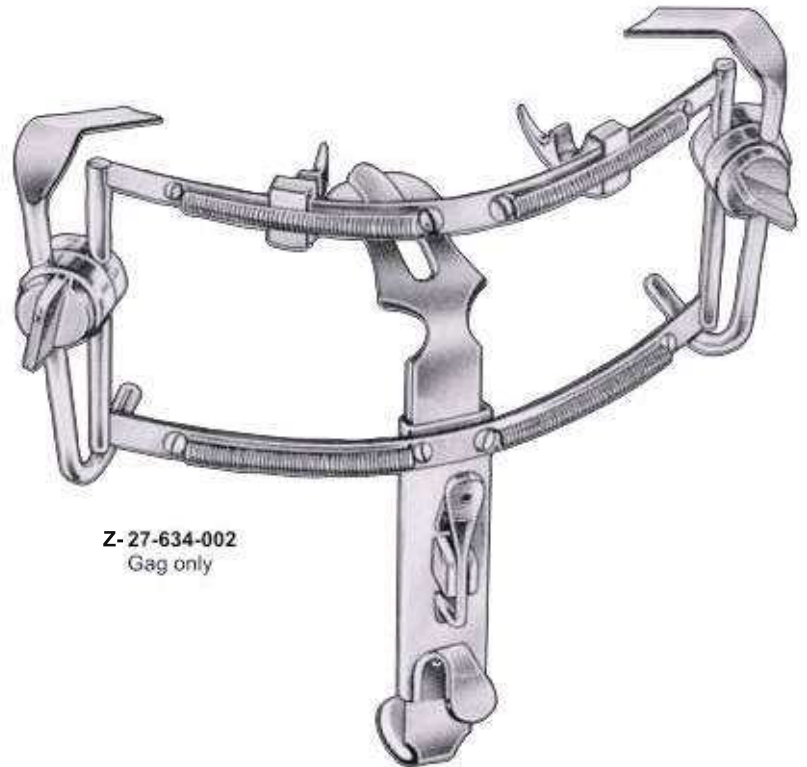

Z-27-634-002  
Gag only

**DINGMANN**  
Z-27-633-001  
complete

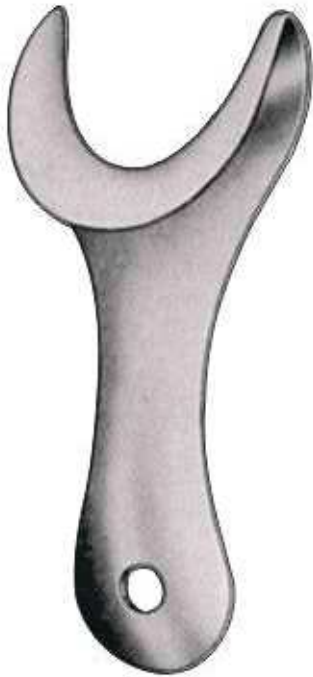

**SIMPLEX**  
Z-27-638-110  
11 cm, 4 1/4"



**STERNBERG**  
Z-27-639-120 12 cm, 5"  
Z-27-640-140 14 cm, 5 1/2"  
Z-27-641-160 16 cm, 6 1/4"

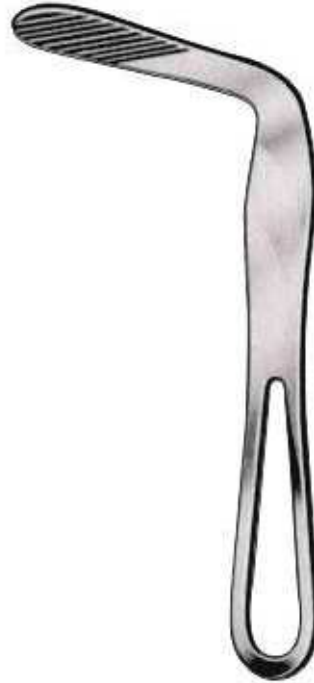

**HARTMANN**  
Z-27-642-150  
15 cm, 6"



**UNIV. MINNESOTA**  
Z-27-643-140  
14 cm, 5 1/2"



Z-27-644-190  
19 cm, 7 1/2"



**ROUX**  
Z-27-645-150  
15 cm, 6"  
Cheek Retractor

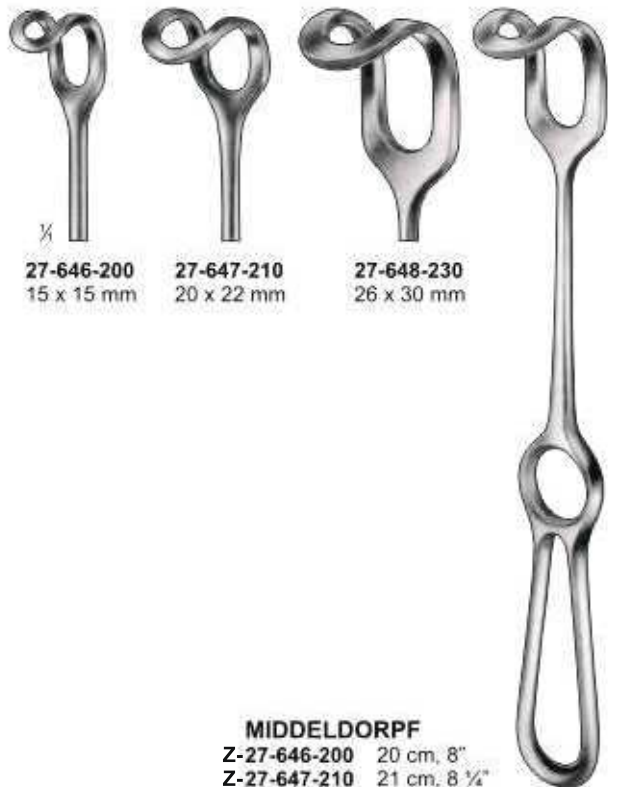

27-646-200 15 x 15 mm  
27-647-210 20 x 22 mm  
27-648-230 26 x 30 mm

**MIDDELDORPF**  
Z-27-646-200 20 cm, 8"  
Z-27-647-210 21 cm, 8 1/4"  
Z-27-648-230 23 cm, 9"

# TONSIL GRASPING FORCEPS, TONSIL FORCEPS

Tonsillenfasszangen, Tonsillenklemmen  
Pinzas Para Amigdalas

Pinces Pour Amygdalas  
Pinze Per Tonsille



**MARSCHIK-KRONE**  
Tonsil holding forceps  
Z-27-649-200 20 cm, 8"



**BLOHMKE**  
Tonsil holding forceps  
Z-27-650-200 20 cm, 8"



**ABRAHAM**  
Tonsil holding forceps  
Z-27-651-200 20 cm, 8"



**BLOHMKE**  
Tonsil holding forceps  
Z-27-652-200 20 cm, 8"



# TONSIL GRASPING FORCEPS, TONSIL FORCEPS

Tonsillenfasszangen, Tonsillenklemmen  
Pinzas Para Amigdalas

Pinces Pour Amygdalas  
Pinze Per Tonsille



**WHITE**  
Z-27-653-180 18 cm, 7"  
Z-27-654-230 23 cm, 9"



**COLVER**  
19 cm, 7 1/2"

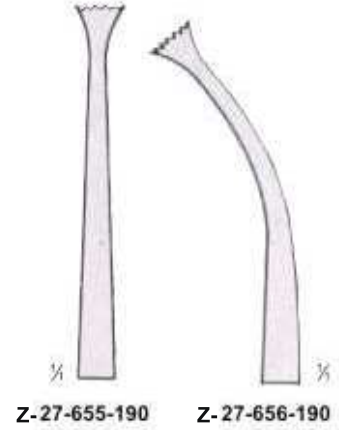

**SCHROEDER**  
Z-27-657-240  
24 cm, 9 1/2"



**LAHEY**

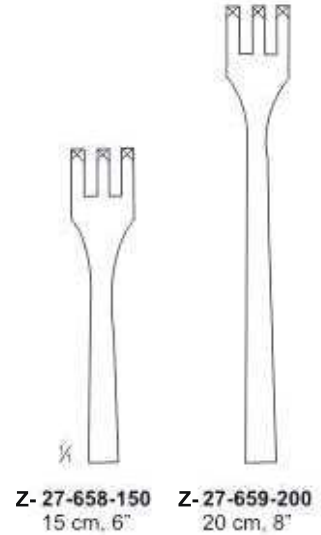



**STAUDE-MOORE**  
Z-27-660-170  
17 cm, 6 1/2"  
strong pattern



**POZZI**  
Z-27-661-170  
25.5 cm, 10 1/4"



**SCHROEDER**  
Z-27-662-250  
25 cm, 10"



**BRAUN**  
Z-27-663-250  
25 cm, 10"



**DUPLAY**  
Z-27-664-280  
28 cm, 11"



**BEACHAM**  
Z-27-665-260  
26 cm, 10 1/4"



**SKENE**  
Z-27-666-240  
24 cm, 9 1/2"

# TONSIL FORCEPS

Tonsillenklemmen  
Pinzas Para Amigdalas

Pinces Pour Amygdalas  
Pinze Per Tonsille

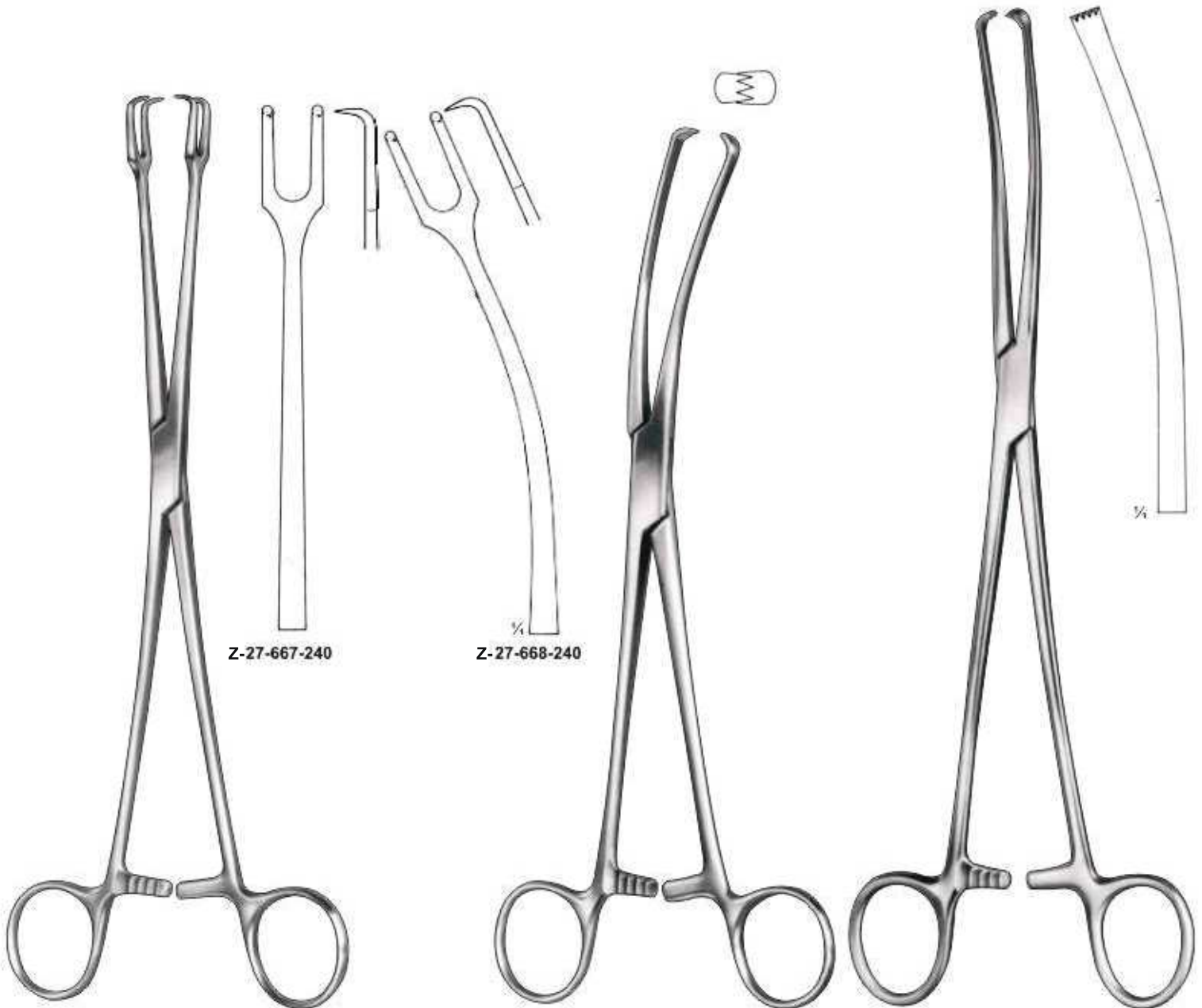

**SCHROEDER**  
24 cm, 9 1/2"

**TEALE**  
Z-27-669-230  
23 cm, 9"

**IOWA**  
Z-27-670-260  
26 cm, 10 1/4"  
for the amnion  
bladder

Tonsillenklemmen  
Pinzas Para Amigdalas

**TONSIL FORCEPS** **ZIANA**  
Pincas Pour Amygdalas  
Pinze Per Tonsille **INDUSTRIES**



**MUSEUX**  
24 cm, 9 1/2"



**JACOBS**  
Z-27-674-210  
21 cm, 8 1/4"

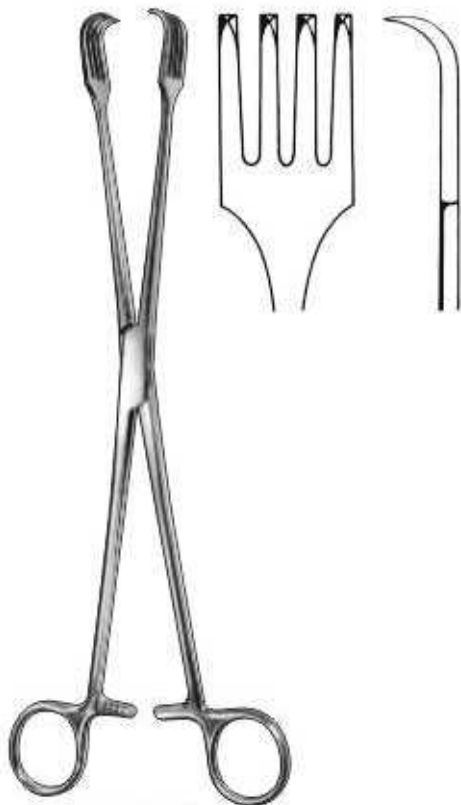
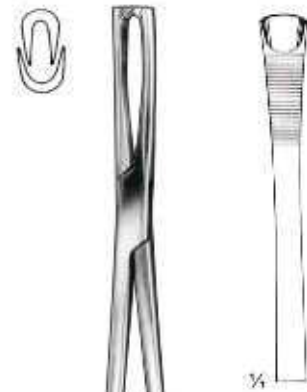

**Z-27-675-260**  
26 cm, 10 1/4"



**BRAUN**  
Z-27-676-155  
15.5 cm, 6 1/4"



**CZERNY**  
Z-27-677-205  
20.5 cm, 8 1/4"

**TONSIL DISSECTOR**

Tonsillenelevator/Retraktor  
Disector/Reparador Para Amígdalas

Dissecteur/Rétracteur Pour Amygdales  
Disettori/Retrattori Per Tonsille



**HENKE**  
Tonsil dissector  
and retractor  
Z-27-678-230  
23 cm 9"

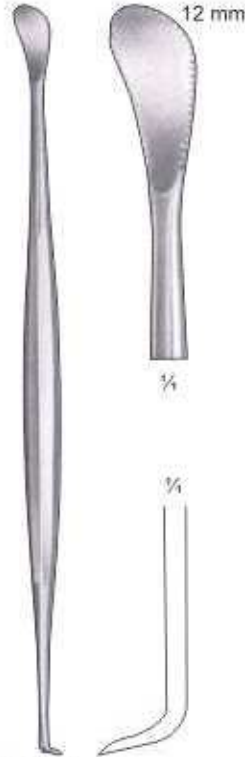

**HENKE**  
Tonsil dissector and  
pillar retractor  
Z-27-679-230  
23 cm 9"



**GAYNE EVANS**  
Tonsil dissector,  
double ended  
Z-27-680-200  
20 cm 8"



**SYME**  
Tonsil dissector, blunt  
and semi-sharp  
Z-27-681-185  
18.5 cm 7 1/4"



**MOLLINSON**  
Tonsil dissector and  
pillar retractor, sharp  
semi  
Z-27-682-225 22.5 cm 9"



**LUNIATSCHECK**  
Z-27-683-190  
19 cm, 7 1/2"

Tonsillenelevator/Retraktor  
Disector/Reparador Para Amígdalas

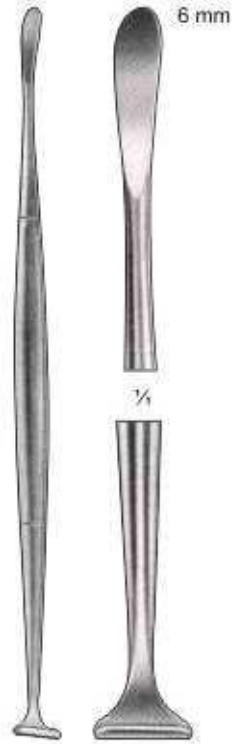

**HARD**  
Tonsil dissector and  
pillar retractor  
Z-27-684-215 21.5 cm 8 1/2"

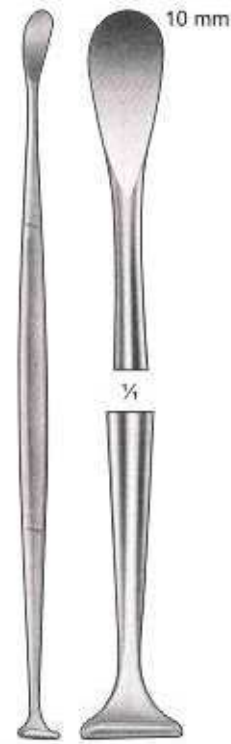

**HARD**  
Tonsil dissector and  
pillar retractor  
Z-27-685-215 21.5 cm 8 1/2"



**LORER-REINKE**  
Tonsil suction dissector  
Z-27-686-235 23.5 cm 9 1/4"



**KOCHER**



Z-27-687-150  
15 cm, 6"  
Z-27-688-160  
16 cm, 6 1/4"



Z-27-689-150  
15 cm, 6"  
Z-27-690-160  
16 cm, 6 1/4"

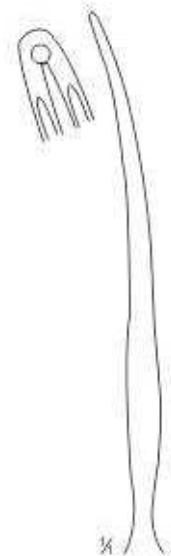

Z-27-691-180  
18 cm, 7"

**TONSIL SNARES**

Tonsillenschnürer  
Cierra-nudos Para Amigdalas

Serre-noeuds Pour Amygdalas  
Serranodi Per Tonsille



**EVES**  
Z-27-692-280  
28 cm, 11"



**EVES**  
Z-27-693-280  
28 cm, 11"

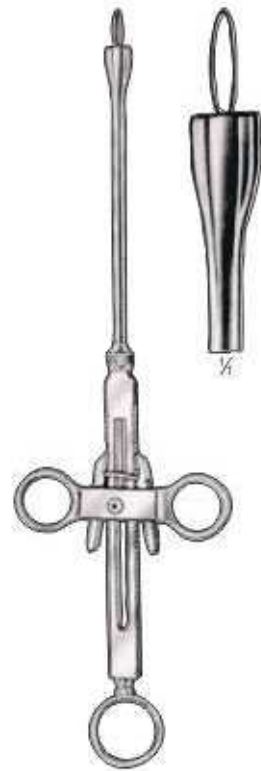

**BRUENINGS**  
Z-27-694-280  
28 cm, 11"



Pack. Of 100 pcs.  
Z-27-695-001 = 40mm  
Z-27-696-002 = 50mm



Pack. Of 12 pcs.  
Z-27-697-001 = 0.3mm Ø

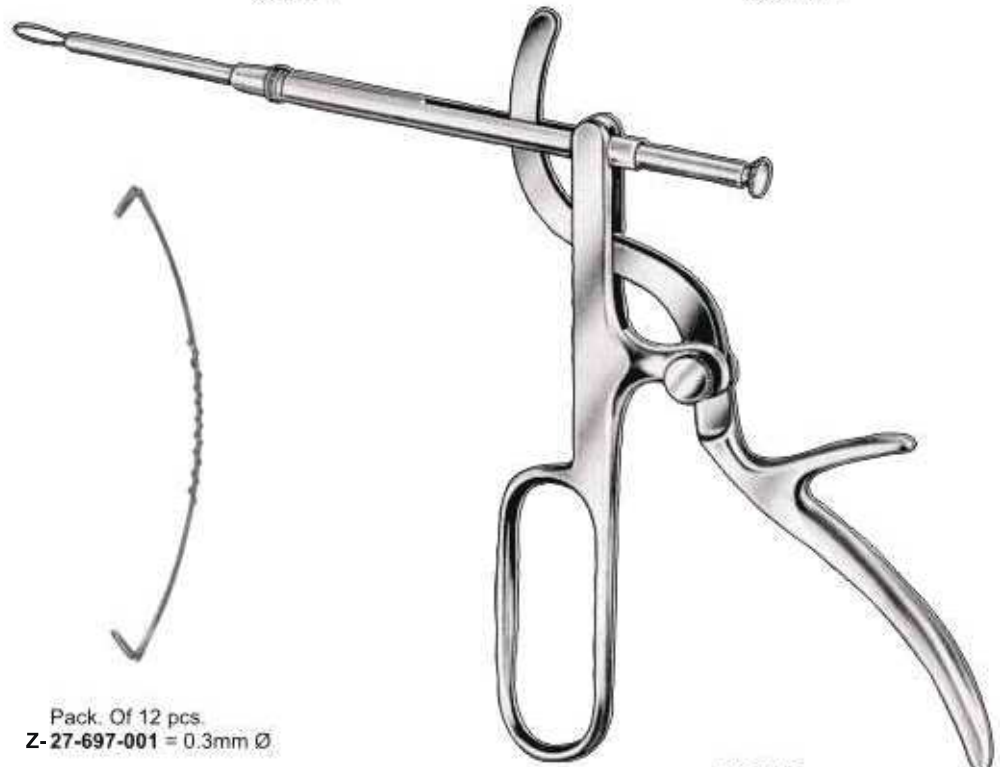

**TYDING**  
Z-27-698-001

Tonsillenschnürer  
Cierra-nudos Para Amígdalas

**TONSIL SNARES** **ZIANA**  
Serre-noeuds Pour Amygdalas  
Serranodi Per Tonsille **INDUSTRIES**

Complete, with 3 tips fig. 1-3



Z-27-699-001



Z-27-700-002



Z-27-701-003

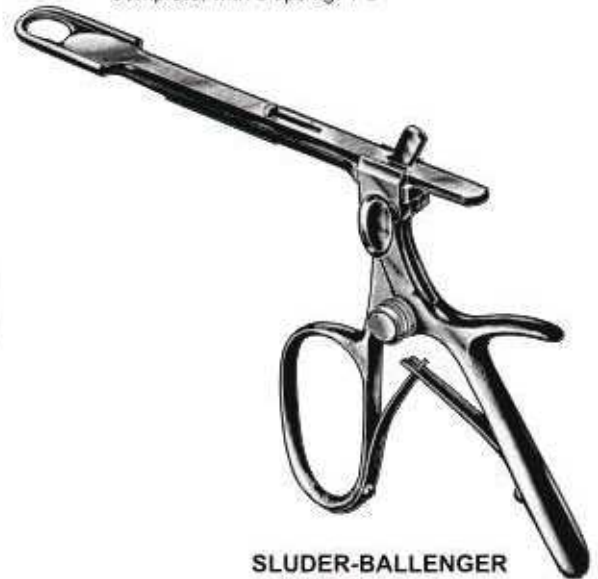

**SLUDER-BALLENGER**  
Z-27-702-004  
complete, with 3 tips fig. 1-3  
Blades For Tonsillotome Handle



**RODER**  
Z-27-703-265  
26.5 cm, 10 1/2"



**HOFER**  
Z-27-704-240  
24 cm, 9 1/2"



**NAGER**  
Z-27-705-230  
23 cm, 9"



**LOVE**  
Z-27-706-180 18 cm, 7"  
Z-27-707-200 20 cm, 8"  
Z-27-708-220 22 cm, 8 1/2"



**HASLINGER**  
Z-27-709-170  
17 cm, 6 3/4"



**MATIN**  
Z-27-710-170  
17 cm, 6 3/4"



# SINUS AND ETHMOID CURETTES

Curettes pour sinus et ethmoïde  
Nasennebenhöhlen- und siebbeinküretten

Curette per etmoide e seni nasali  
Curetas para la etmoides y el seno nasal



**Z-27-711-165**  
Slightly angled  
16.5 cm, 6 1/2"



**Z-27-712-165**  
Slightly angled 45°  
16.5 cm, 6 1/2"



**Z-27-713-150**  
Slightly angled 90°  
15 cm, 6"



**Z-27-714-150**  
Straight oval jaw.  
15 cm, 6"



**Z-27-715-165**  
angled 45°  
16.5 cm, 6 1/2"



**Z-27-716-150**  
Slightly angled  
15 cm, 6"



**COAKLEY SINUS CURETTES**

Up

Down



**Z-27-717-245**  
Straight angled 45°  
24.5 cm, 10"



**Z-27-718-250**  
angled 45°  
25.0 cm, 10"

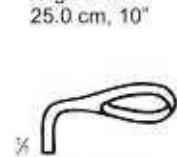

**Z-27-719-235**  
angled 90°  
23.5 cm, 9 1/2"

**COAKLEY SINUS CURETTES**



**PRATT ETHMOID CURETTES**  
**Z-27-720-220**  
22 cm, 8 3/4"

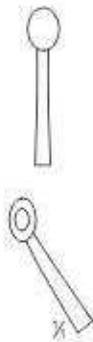

**FAULKNER ETHMOID CURETTES**  
**Z-27-721-222**  
22.2 cm, 8 3/4"



**Beckmann**  
22 cm, 8 3/4"



Z-27-722-001



Z-27-723-002



**Beckmann (Negus)**  
22 cm, 8 3/4"



Z-27-728-001



Z-27-729-002



Z-27-724-003



Z-27-725-004



Z-27-730-003



Z-27-731-004



Z-27-726-005



Z-27-727-006



Z-27-732-006



Z-27-733-006



**BARNHILL**  
22 cm, 8 3/4"



Z-27-734-220

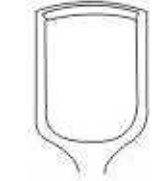

Z-27-735-220



Z-27-736-220

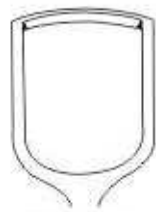

Z-27-737-220



**ST. CLAIR-THOMSON**  
21cm, 8 1/4"



Z-27-738-210



Z-27-739-210



Z-27-740-210



Z-27-741-210



**LA FORCEPS**  
Adenotomes  
23 cm, 9"



Z-27-742-230



Z-27-743-230



Z-27-744-230

*Kehlkopfspiegel, Kehlkopfspiegel-griffe*

*Espejos Laringeos, Mangos Para Espejos Laringeos*

*Miroirs Laryngiens, Manche Pour Miroirs Laryngiens*

*Specchi Laringei, Manico Per Specchi Laringei*



**LARYNGEAL  
MIRROR**  
with Handle



**Z-27-745-001**  
fig 00 = 8mm



**Z-27-746-002**  
fig 0 = 10mm



**Z-27-747-003**  
fig 1 = 12mm

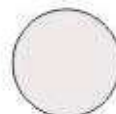

**Z-27-748-004**  
fig 2 = 14mm

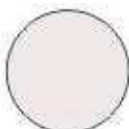

**Z-27-749-005**  
fig 3 = 16mm



**Z-27-750-006**  
fig 4 = 18mm

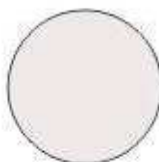

**Z-27-751-007**  
fig 5 = 20mm

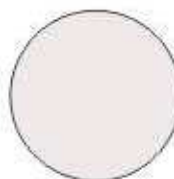

**Z-27-752-008**  
fig 6 = 22mm

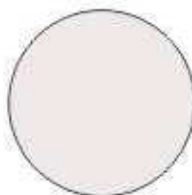

**Z-27-753-009**  
fig 7 = 24mm

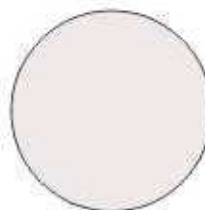

**Z-27-754-010**  
fig 8 = 26mm



LUER

Fig.	mm ø	N	M	R
		46-90 mm	95 mm	46-90 mm
0	4 mm	27-755-004		
1	5 mm	27-756-005		
2	6 mm	27-757-006		
3	7 mm	27-758-007		
4	8 mm	27-759-008	Z-27-765-008	Z-27-771-008
5	9 mm	27-760-009	Z-27-766-009	Z-27-772-009
6	10 mm	27-761-010	Z-27-767-010	Z-27-773-010
7	11 mm	27-762-011	Z-27-768-011	Z-27-774-011
8	12 mm	27-763-012	Z-27-769-012	Z-27-775-012
9	13 mm	27-764-013	Z-27-770-013	Z-27-776-013



CHEVALIER-JACKSON

Fig.	mm ø	N
		46-90 mm
0	4 mm	Z-27-777-004
1	5 mm	Z-27-778-005
2	6 mm	Z-27-779-006
3	7 mm	Z-27-780-007
4	8 mm	Z-27-781-008
5	9 mm	Z-27-782-009
6	10 mm	Z-27-783-010
7	11 mm	Z-27-784-011
8	12 mm	Z-27-785-012
9	13 mm	Z-27-786-013



**SPEAKING TUBE**  
outer tube closed  
inner tube closed  
Z-27-787-001

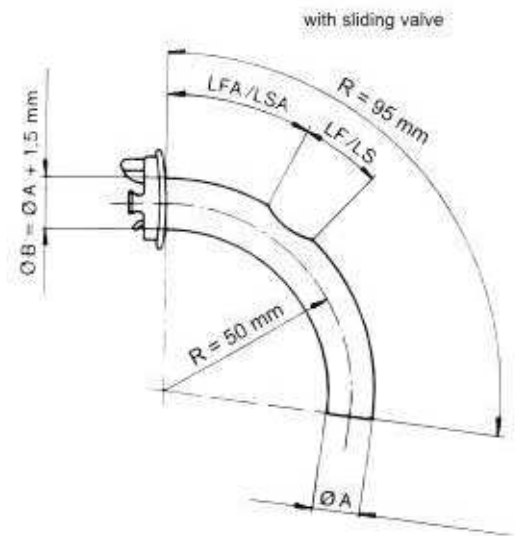
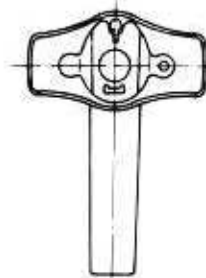

Fig.	Item	Ø A	L	Radius
A	27-788-008	08mm	95mm	50mm
A	27-789-009	09mm	95mm	50mm
A	27-790-010	10mm	95mm	50mm
A	27-791-011	11mm	95mm	50mm
A	27-792-012	12mm	95mm	50mm
A	27-793-013	13mm	95mm	50mm

**TONGUE HOLDING FORCEPS, TRACHEOTOMY TROCAR**

Zungenzangen, Trachealtrokar  
Pinzas Tira-lengua, Traqueótomio

Pinces Tire-langue, Trocart Pour La Trachéotomie  
Pinze Per Lingua, Trocarto Per Tracheotomia



Z-27-794-130  
7.5mm

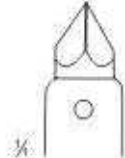

Z-27-795-130  
9mm

**UCKERMANN**  
13 cm, 5 1/4"



**LABORDE**  
Z-27-796-140  
14 cm, 5 1/2"



**TROUSSEAU**  
Z-27-797-140  
14 cm, 5 1/2"



27-799-001  
pair

**YOUNG**  
Z-27-798-170  
16 cm, 6 1/4"

# ALAR HOOKLETS, NASAL RETRACTORS

Nasenflügelhäkchen, Nasenhaken

Ganchitos Para Alas De Nariz, Separadores Nasaes,

Crochets Pour Les Ailes Du Nez, Ecarteurs Nasaux

Uncini Per Le Pinne Nasali, Divaricatori Nasali



**HOOK RETRACTOR,**  
**Z-27-800-160**  
 single, blunt  
 16 cm, 6 1/4"

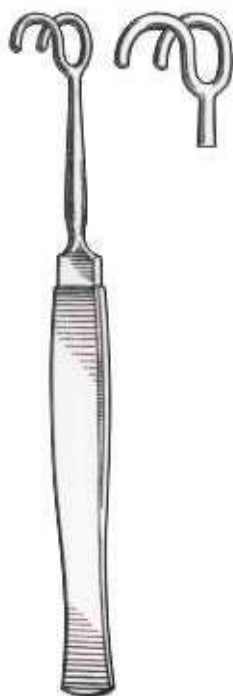

**HOOK RETRACTOR,**  
**Z-27-801-160**  
 double, blunt  
 16 cm, 6 1/4"



**ROSE**  
**Z-27-802-130**  
 13 cm, 5 1/4"



**LUER**  
**Z-27-803-110**  
 11 cm, 4 1/4"



**JACKSON**  
**Z-27-804-150**  
 15 cm, 6"



**NEWS**  
**Z-27-805-150**  
 15 cm, 6"



Left

**BOSE**  
**Z-27-806-160**  
 16 cm, 6 1/4"



Right

**BOSE**  
**Z-27-807-160**  
 16 cm, 6 1/4"



**ITERSON**  
**Z-16 cm, 6 1/4"**



**27-808-160**  
 Sharp



**27-809-160**  
 Blunt



**SCHOENBORN**  
**Z-27-810-210**  
 21 cm, 8 1/4"



**LUKENS**  
**Z-27-811-170**  
 17 cm, 6 3/4"

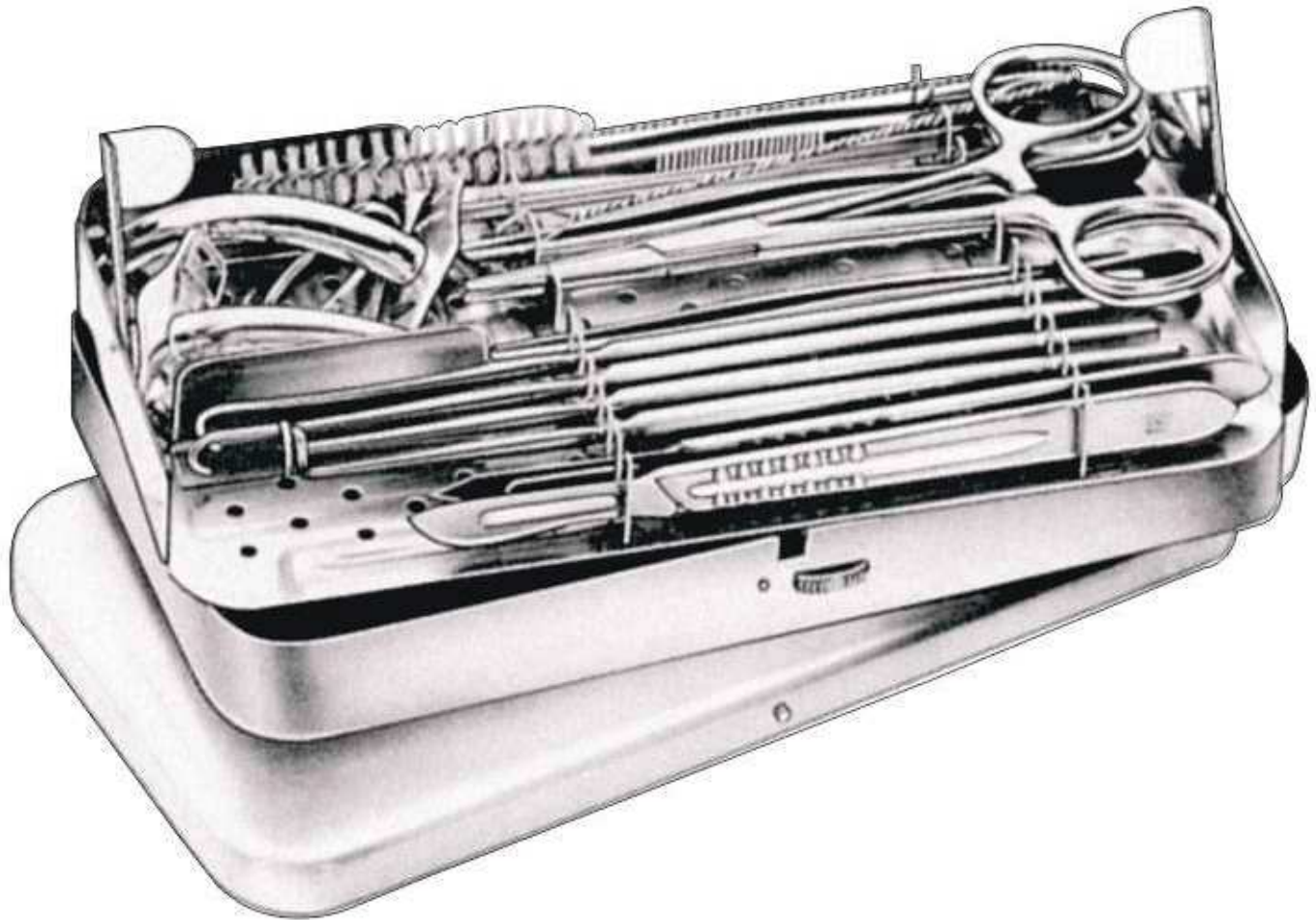

- Z-27-812-001 1 Metal Case
- In Metal Case Consisting Of:
- Z-27-813-002 1 Handle With 1 Blade Fig. 20
- Z-27-814-003 1 Handle With 1 Blade Fig. 23
- Z-27-815-004 1 Thumb Forceps 13cm
- Z-27-816-005 1 Tissue Forceps 13cm, 1 x 2 teeth
- Z-27-817-006 2 Pean Artery Forceps 13cm
- Z-27-818-007 1 Grooved Director 13cm
- Z-27-819-008 1 Trachea Dilator
- Z-27-820-009 2 Trachea Retractors, Iterson, Blunt
- Z-27-821-010 1 Trachea Retractor, Bose, Sharp, Left
- Z-27-822-011 1 Trachea Retractor, Bose, Sharp, Right
- Z-27-823-012 1 Luer Trachea Tube Standard
- Z-27-824-013 1 Luer Trachea Tube Standard
- Z-27-825-014 1 Cleaning Brush

Manche laryngien universel  
Kehlkopf-universalgriffe

# UNIVERSAL LARYNGEAL **ZIANA** INDUSTRIES

Manici, tubi e punte universali per strumenti chirurgici per laringe  
Mangos, tubos y puntas universales para lalaringe



**Z-27-826-001**  
Chest Support and **LARYNGOSCOPE HOLDER**,  
complete, for adults and children

**Z-27-827-180**  
18 cm, 7"  
Operating Laryngoscope,  
for adults, large



**Z-27-828-180**  
18 cm, 7"  
Operating Laryngoscope,  
for adults, medium



**Z-27-829-130**  
13 cm, 5"  
Operating Laryngoscope,  
for children



**Z-27-830-180**  
18 cm, 7"  
Operating Laryngoscope,  
for adults, small



**Z-27-831-001**  
Light guide for use  
**LARYNGOSCOPES**



**Z-27-832-001**  
Light guide for use  
**LARYNGOSCOPES**





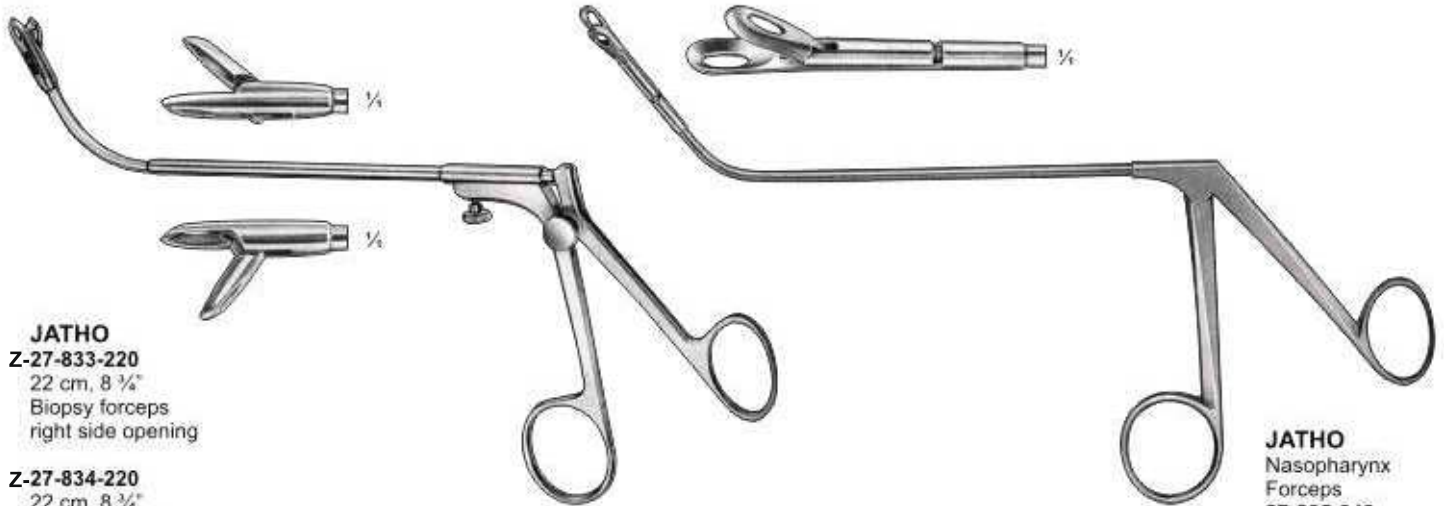

**JATHO**  
Z-27-833-220  
22 cm, 8 1/4"  
Biopsy forceps  
right side opening

Z-27-834-220  
22 cm, 8 1/4"  
Biopsy forceps  
left side opening

**JATHO**  
Nasopharynx  
Forceps  
Z-27-835-240  
24 cm, 9 1/2"

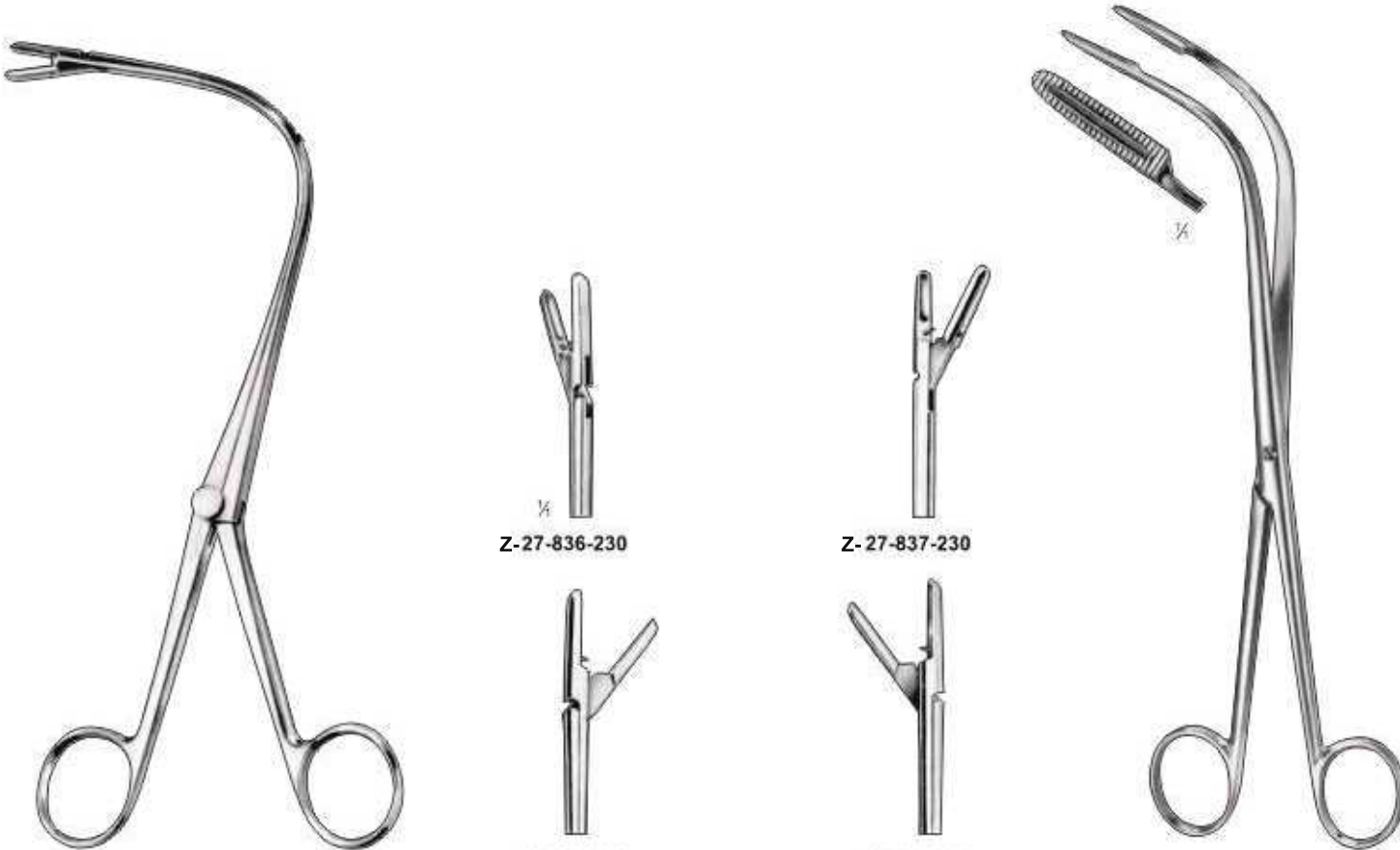

Z-27-836-230

Z-27-837-230

Z-27-838-230

Z-27-839-230

**JURASZ**  
Z-27-836-230 lateral biting to the right  
Z-27-837-230 lateral biting to the left  
Z-27-838-230 downwards biting  
Z-27-839-230 upwards biting  
23 cm, 9"  
Laryngeal Polypus Forceps

**TOBOLD**  
Z-27-840-230  
Laryngeal polypus forceps,  
curved sideways  
23 cm, 9"

Broncho-Oesophagoskopiezangen  
Pinzas Para Broncho-Esofagoscopia

Pinces Pour Broncho-Esophagoscopie  
Pinze Per Broncho-Esofagoscopia



**BRÜNINGS**  
Z-27-841-001  
Universal handle, with lever  
on the left, for use with  
tubes  
Z-27-842-200 to  
Z-27-843-500



**AESCULAP**  
Z-27-844-001  
14 cm, 5 1/2"  
Universal handle, with lever  
on the right, for use with  
tubes  
Z-27-845-200 to  
Z-27-846-500

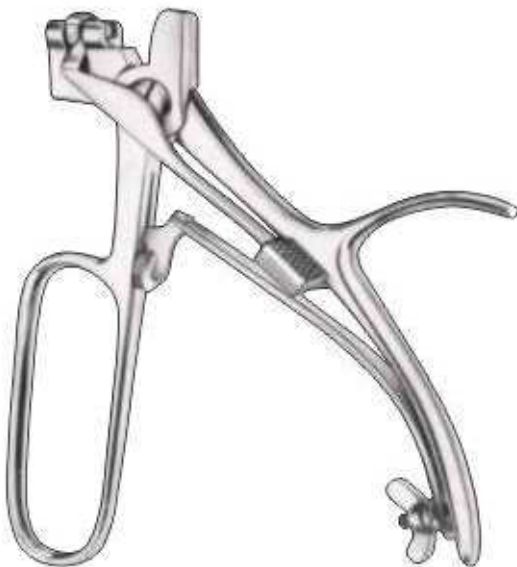

**HUBER**  
Z-27-847-001  
14 cm, 5 1/2"  
Universal handle, with lever  
on the right, for use with  
tubes  
Z-27-848-200 to  
Z-27-849-500



**BRÜNINGS**  
Z-27-850-200  
20 cm, 8"  
Curved Tube with Stylet,



**BRÜNINGS**  
Z-27-851-200 20 cm, 8"  
Z-27-852-250 25 cm, 10"  
Z-27-853-300 30 cm, 12"  
Z-27-854-350 35 cm, 14"  
Z-27-855-400 40 cm, 16"  
Z-27-856-500 50 cm, 20"  
Straight Tubes with  
Stylet, stiff

# EXCHANGEABLE TIPS FOR BRONCHO-ESOPHAGOSCOPY FORCEPS

Auswechselbare Zangenaufsätze, Broncho-Oesophagoskopiezangen  
Pinzas Intercambiables, Pinzas Para Broncho-Esofagoscopia

Embouts Interchangeables, Pinces Pour Broncho-Esophagoscopie  
Pinze Intercambiabili, Pinze Per Broncho-Esofagoscopia

Z-27-857-001



**LANGE**  
Z-27-869-013



27-858-002



**KRAUSE**  
Z-27-870-014  
Z-27-871-015

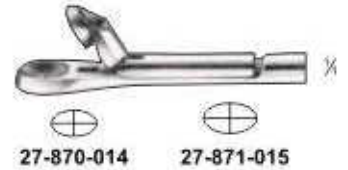

27-870-014    27-871-015

**KAHLER**  
Z-27-859-003



**EICKEN**  
Z-27-860-004



**SCHEINMANN**  
Z-27-872-016



**FRAENKEL**  
Z-27-861-005



**SCHEINMANN**  
Z-27-873-017



**FRAENKEL**  
Z-27-862-006



**SCHEINMANN**  
Z-27-863-007



**CORDES**  
Z-27-874-018



**BRÜNINGS**  
Z-27-864-008 Ø 2 mm.  
Z-27-865-009 Ø 3 mm.  
Z-27-866-010 Ø 4 mm.



**CORDES**  
Z-27-875-019



**BRÜNINGS**  
Z-27-867-011



**ROSENBRG**  
Z-27-876-020



**LANGE**  
Z-27-868-012



**STRUYCKEN**  
Z-27-877-021



- KIDNEY TRAYS
- INSTRUMENTS BOXES
- STERILIZING DRUMS

- MESH BASKETS
- JARS





**STERILIZING DRUMS**

	Ø mm	h mm
Z-35-001-001	80	80
Z-35-002-002	120	120
Z-35-003-003	160	120
Z-35-004-004	190	140
Z-35-005-005	190	200
Z-35-006-006	240	120
Z-35-007-007	240	160
Z-35-008-008	240	240
Z-35-009-009	290	120
Z-35-010-010	290	160
Z-35-011-011	290	240
Z-35-012-012	340	160
Z-35-013-013	340	240
Z-35-014-014	390	145
Z-35-015-015	390	200
Z-35-016-016	390	290



**STERILIZING DRUM**

	Ø mm	h mm
Z-35-017-001	150	150
Z-35-018-002	175	175
Z-35-019-003	190	190
Z-35-020-004	200	140
Z-35-021-005	200	200
Z-35-022-006	240	120
Z-35-023-007	225	225
Z-35-024-008	240	240
Z-35-025-009	290	160
Z-35-026-010	280	240
Z-35-027-011	230	150
Z-35-028-012	300	250
Z-35-029-013	340	250
Z-35-030-014	350	250
Z-35-031-015	390	200



**STERILIZING DRUM**

	Ø mm	h mm
Z-35-032-001	150	150
Z-35-033-002	175	175
Z-35-034-003	190	190
Z-35-035-004	200	140
Z-35-036-005	200	200
Z-35-037-006	240	120
Z-35-038-007	225	225
Z-35-039-008	240	240
Z-35-040-009	290	160
Z-35-041-010	280	240
Z-35-042-011	230	150
Z-35-043-012	300	250
Z-35-044-013	340	250
Z-35-045-014	350	250
Z-35-046-015	390	200



**STERILIZING DRUM**

	Ø mm	h mm
Z-35-047-001	150	150
Z-35-048-002	175	175
Z-35-049-003	190	190
Z-35-050-004	200	140
Z-35-051-005	200	200
Z-35-052-006	240	120
Z-35-053-007	225	225
Z-35-054-008	240	240
Z-35-055-009	290	160
Z-35-056-010	280	240
Z-35-057-011	230	150
Z-35-058-012	300	250
Z-35-059-013	340	250
Z-35-060-014	350	250
Z-35-061-015	390	200



**STERILIZING DRUM**

	Ø mm	h mm
Z-35-062-001	150	150
Z-35-063-002	175	175
Z-35-064-003	190	190
Z-35-065-004	200	140
Z-35-066-005	200	200
Z-35-067-006	240	120
Z-35-068-007	225	225
Z-35-069-008	240	240
Z-35-070-009	290	160
Z-35-071-010	280	240
Z-35-072-011	230	150
Z-35-073-012	300	250
Z-35-074-013	340	250
Z-35-075-014	350	250
Z-35-076-015	390	200



**G LOVES BOX**  
35-077-001  
300 x 150 mm



**INSTRUMENT TRAY WITH COVER**  
35-078-001



**INSTRUMENT TRAY**  
35-079-001



**CATHER TRAY**  
Size:  
35-080-001 230 x 75 mm  
35-081-002 350 x 90 mm  
35-082-003 430 x 100 mm  
35-083-004 200 x 100 mm  
35-084-005 300 x 100 mm  
35-085-006 350 x 100 mm



**PERFORATED BOX**

	Size
Z-35-087-001	100 x 50 mm
Z-35-088-002	165 x 65 mm
Z-35-089-003	250 x 100 mm
Z-35-090-004	250 x 150 mm
Z-35-091-005	250 x 200 mm
Z-35-092-006	150 x 65 mm
Z-35-093-007	170 x 70 mm
Z-35-094-008	200 x 100 mm
Z-35-095-009	250 x 125 mm
Z-35-096-010	300 x 150 mm
Z-35-097-011	300 x 200 mm
Z-35-098-012	300 x 130 mm
Z-35-099-013	320 x 150 mm
Z-35-100-014	420 x 180 mm
Z-35-101-015	460 x 125 mm
Z-35-102-016	355 x 180 mm
Z-35-103-017	300 x 180 mm
Z-35-104-018	400 x 200 mm
Z-35-105-019	510 x 200 mm

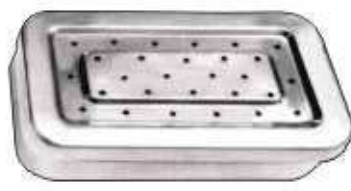

**BOX WITH FILTER**

	Size
Z-35-106-001	100 x 50 mm
Z-35-107-002	165 x 65 mm
Z-35-108-003	250 x 100 mm
Z-35-109-004	250 x 150 mm
Z-35-110-005	250 x 200 mm
Z-35-111-006	150 x 65 mm
Z-35-112-007	170 x 70 mm
Z-35-113-008	200 x 100 mm
Z-35-114-009	250 x 125 mm
Z-35-115-010	300 x 150 mm
Z-35-116-011	300 x 200 mm
Z-35-117-012	300 x 130 mm
Z-35-118-013	320 x 150 mm
Z-35-119-014	420 x 180 mm
Z-35-120-015	460 x 125 mm
Z-35-121-016	355 x 180 mm
Z-35-122-017	300 x 180 mm
Z-35-123-018	400 x 200 mm
Z-35-124-019	510 x 200 mm



**INSTRUMENTS BOX**  
Without Clip

	Size
Z-35-125-001	100 x 50 mm
Z-35-126-002	165 x 65 mm
Z-35-127-003	250 x 100 mm
Z-35-128-004	250 x 150 mm
Z-35-129-005	250 x 200 mm
Z-35-130-006	150 x 65 mm
Z-35-131-007	170 x 70 mm
Z-35-132-008	200 x 100 mm
Z-35-133-009	250 x 125 mm
Z-35-134-010	300 x 150 mm
Z-35-135-011	300 x 200 mm
Z-35-136-012	300 x 130 mm
Z-35-137-013	320 x 150 mm
Z-35-138-014	420 x 180 mm
Z-35-139-015	460 x 125 mm
Z-35-140-016	355 x 180 mm
Z-35-141-017	300 x 180 mm
Z-35-142-018	400 x 200 mm
Z-35-143-019	510 x 200 mm



**INSTRUMENT BOX**  
With Clip

	Size
Z-35-144-001	100 x 50 mm
Z-35-145-002	165 x 65 mm
Z-35-146-003	250 x 100 mm
Z-35-147-004	250 x 150 mm
Z-35-148-005	250 x 200 mm
Z-35-149-006	150 x 65 mm
Z-35-150-007	170 x 70 mm
Z-35-151-008	200 x 100 mm
Z-35-152-009	250 x 125 mm
Z-35-153-010	300 x 150 mm
Z-35-154-011	300 x 200 mm
Z-35-155-012	300 x 130 mm
Z-35-156-013	320 x 150 mm
Z-35-157-014	420 x 180 mm
Z-35-158-015	460 x 125 mm
Z-35-159-016	355 x 180 mm
Z-35-160-017	300 x 180 mm
Z-35-161-018	400 x 200 mm
Z-35-162-019	510 x 200 mm



**INSTRUMENT BOILER**

	Size
Z-35-163-001	180 x 80 x 40 mm
Z-35-164-002	200 x 100 x 50 mm
Z-35-165-003	250 x 125 x 40 mm
Z-35-166-004	300 x 150 x 60 mm
Z-35-167-005	350 x 175 x 75 mm
Z-35-168-006	400 x 200 x 100 mm



**PERFORATED TRAY**

	Size
Z-35-169-001	180 x 80 x 40 mm
Z-35-170-002	200 x 100 x 50 mm
Z-35-171-003	250 x 125 x 40 mm
Z-35-172-004	300 x 150 x 60 mm
Z-35-173-005	350 x 175 x 75 mm
Z-35-174-006	400 x 200 x 100 mm



**INSTRUMENT BOILER WITH STAND**

	Size
Z-35-175-001	180 x 80 x 40 mm
Z-35-176-002	200 x 100 x 50 mm
Z-35-177-003	250 x 125 x 40 mm
Z-35-178-004	300 x 150 x 60 mm
Z-35-179-005	350 x 175 x 75 mm
Z-35-180-006	400 x 200 x 100 mm



**INSTRUMENT BOILER ELECTRIC**

	Size
Z-35-181-001	180 x 80 x 40 mm
Z-35-182-002	200 x 100 x 50 mm
Z-35-183-003	250 x 125 x 40 mm
Z-35-184-004	300 x 150 x 60 mm
Z-35-185-005	350 x 175 x 75 mm
Z-35-186-006	400 x 200 x 100 mm



**NEEDLE CASE**  
Z-35-187-001  
230 x 125 mm

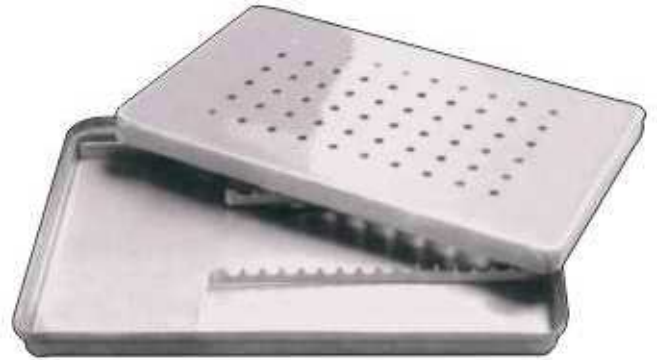

**SCALER BOX**  
Z-35-188-001  
300 x 180 mm



**SCALER TRAY**  
Z-35-189-001  
100 x 200 mm



**INDO BOX WITH SILVER FRAME**  
Z-35-191-001



**Autoclaveable**  
Z-35-190-001



**INSTRUMENT TRAY WITHOUT COVER**

	Size		Size
Z-35-192-001	240 x 240 mm	Z-35-203-012	230 x 125 mm
Z-35-193-002	355 x 400 mm	Z-35-204-013	200 x 150 mm
Z-35-194-003	300 x 150 mm	Z-35-205-014	250 x 200 mm
Z-35-195-004	300 x 180 mm	Z-35-206-015	300 x 250 mm
Z-35-196-005	300 x 240 mm	Z-35-207-016	350 x 300 mm
Z-35-197-006	340 x 320 mm	Z-35-208-017	400 x 350 mm
Z-35-198-007	230 x 180 mm	Z-35-209-018	450 x 300 mm
Z-35-199-008	250 x 130 mm	Z-35-210-019	300 x 200 mm
Z-35-200-009	200 x 130 mm	Z-35-211-020	350 x 250 mm
Z-35-201-010	180 x 130 mm	Z-35-212-021	250 x 125 mm
Z-35-202-011	150 x 100 mm	Z-35-213-022	200 x 100 mm
		Z-35-214-023	400 x 200 mm

**INSTRUMENT TRAY WITHOUT COVER**

	Size		Size
Z-35-215-001	240 x 240 mm	Z-35-226-012	230 x 125 mm
Z-35-216-002	355 x 400 mm	Z-35-227-013	200 x 150 mm
Z-35-217-003	300 x 150 mm	Z-35-228-014	250 x 200 mm
Z-35-218-004	300 x 180 mm	Z-35-229-015	300 x 250 mm
Z-35-219-005	300 x 240 mm	Z-35-230-016	350 x 300 mm
Z-35-220-006	340 x 320 mm	Z-35-231-017	400 x 350 mm
Z-35-221-007	230 x 180 mm	Z-35-232-018	450 x 300 mm
Z-35-222-008	250 x 130 mm	Z-35-233-019	300 x 200 mm
Z-35-223-009	200 x 130 mm	Z-35-234-020	350 x 250 mm
Z-35-224-010	180 x 130 mm	Z-35-235-021	250 x 125 mm
Z-35-225-011	150 x 100 mm	Z-35-236-022	200 x 100 mm
		Z-35-237-023	400 x 200 mm





**KIDNEY TRAY WITH COVER**  
(English Pattern)

	Size
Z-35-238-001	150 mm
Z-35-239-002	200 mm
Z-35-240-003	240 mm
Z-35-241-004	300 mm



**KIDNEY TRAY (German Pattern)**  
(without cover)

	Size
Z-35-242-001	150 mm
Z-35-243-002	200 mm
Z-35-244-003	240 mm
Z-35-245-005	300 mm



**SPLIT LAMP**  
Z-35-246-001  
100 ml.



**BOWL**

	Size
Z-35-247-001	80 mm
Z-35-248-002	100 mm
Z-35-249-003	125 mm
Z-35-250-004	150 mm
Z-35-251-005	200 mm
Z-35-252-006	250 mm
Z-35-253-007	300 mm
Z-35-254-008	350 mm
Z-35-255-009	400 mm



**WASH BASIN**

	Size
Z-35-256-001	80 mm
Z-35-257-002	100 mm
Z-35-258-003	125 mm
Z-35-259-004	150 mm
Z-35-260-005	200 mm
Z-35-261-006	250 mm
Z-35-262-007	300 mm
Z-35-263-008	350 mm
Z-35-264-009	400 mm



**BOWL**

	Size
35-265-001	80 mm
35-266-002	100 mm
35-267-003	125 mm
35-268-004	150 mm
35-269-005	200 mm
35-270-006	250 mm
35-271-007	300 mm
35-272-008	350 mm
35-273-009	400 mm



**DRESSING JAR WITH KNOB**

	Size
Z-35-274-001	80 x 80 mm
Z-35-275-002	100 x 100 mm
Z-35-276-003	125 x 125 mm
Z-35-277-004	150 x 150 mm
Z-35-278-005	200 x 200 mm



**DRESSING JAR**

	Size
Z-35-279-001	80 x 80 mm
Z-35-280-002	100 x 100 mm
Z-35-281-003	125 x 125 mm
Z-35-282-004	150 x 150 mm
Z-35-283-005	200 x 200 mm



**DRESSING JAR**

	Size
Z-35-284-001	80 x 80 mm
Z-35-285-002	100 x 100 mm
Z-35-286-003	125 x 125 mm
Z-35-287-004	150 x 150 mm
Z-35-288-005	200 x 200 mm



**DRESSING JAR**

	Size
Z-35-289-001	80 x 80 mm
Z-35-290-002	100 x 100 mm
Z-35-291-003	125 x 125 mm
Z-35-292-004	150 x 150 mm
Z-35-293-005	200 x 200 mm



**FORCEPS JAR**

	Size
Z-35-294-001	55 x 100 mm
Z-35-295-002	55 x 140 mm
Z-35-296-003	55 x 170 mm
Z-35-297-004	55 x 180 mm
Z-35-298-005	80 x 100 mm



**FORCEPS JAR**

	Size
Z-35-299-001	55 x 100 mm
Z-35-300-002	55 x 140 mm
Z-35-301-003	55 x 170 mm
Z-35-302-004	55 x 180 mm
Z-35-303-005	80 x 100 mm



**FORCEPS JAR**

	Size
Z-35-304-001	55 x 100 mm
Z-35-305-002	55 x 140 mm
Z-35-306-003	55 x 170 mm
Z-35-307-004	55 x 180 mm
Z-35-308-005	80 x 100 mm



**FORCEPS JAR**

	Size
Z-35-309-001	55 x 100 mm
Z-35-310-002	55 x 140 mm
Z-35-311-003	55 x 170 mm
Z-35-312-004	55 x 180 mm
Z-35-313-005	80 x 100 mm



**FORCEPS JAR**

	Size
Z-35-314-001	55 x 100 mm
Z-35-315-002	55 x 140 mm
Z-35-316-003	55 x 170 mm
Z-35-317-004	55 x 180 mm
Z-35-318-005	80 x 100 mm



**COTTON HOLDER**  
Z-35-319-001



**GALIPOTS**

	Capacity
Z-35-320-001	2 Ounces
Z-35-321-002	3 Ounces
Z-35-322-003	4 Ounces
Z-35-323-004	5 Ounces
Z-35-324-005	6 Ounces
Z-35-325-006	7 Ounces
Z-35-326-007	8 Ounces



**GALIPOTS**

	Capacity
Z-35-327-001	2 Ounces
Z-35-328-002	3 Ounces
Z-35-329-003	4 Ounces
Z-35-330-004	5 Ounces
Z-35-331-005	6 Ounces
Z-35-332-006	7 Ounces
Z-35-333-007	8 Ounces



**SPRIT LAMP**  
Z-35-334-001  
100 ml.



**INDO BOX ROUND**  
Z-35-335-001

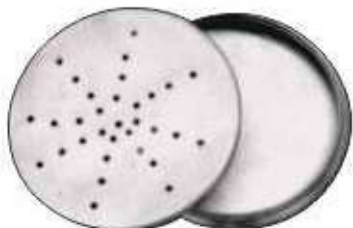

**NEEDLE CASE**  
Z-35-336-001



**MEASURING JUG**

	Capacity
Z-35-337-001	1.00 Ltr
Z-35-338-002	1.50 Ltr
Z-35-339-003	2.00 Ltr



**MEDICINE CUP GRADUATED**

	Capacity
Z-35-340-001	50 ml
Z-35-341-002	60 ml
Z-35-342-003	100 ml



**BUCKET WITH LID**

	Capacity
Z-35-343-001	10 Ltr
Z-35-344-002	12 Ltr
Z-35-345-003	15 Ltr



**SPUTUM MUG**  
Z-35-346-001  
100 x 50 mm



**ENEMA CANE**  
Capacity  
Z-35-347-001 0.5 Ltr  
Z-35-348-002 1.5 Ltr  
Z-35-349-003 2.0 Ltr



**DUST BIN**  
Z-35-350-001  
20 Lit



**ROUND BADPAN**  
Z-35-351-001  
300 x 85 mm



**BEDPAN**  
Z-35-352-001  
Size: Adult, Child



**BEDPAN**  
Z-35-353-001  
Size: Adult, Child



**FURNAL**  
Z-35-354-001  
100 mm



**URINAL - FEMALE**  
Z-35-355-001



**URINAL - MALE**  
Z-35-356-001



**SHAVING MUG**  
Z-35-357-001  
100 mm

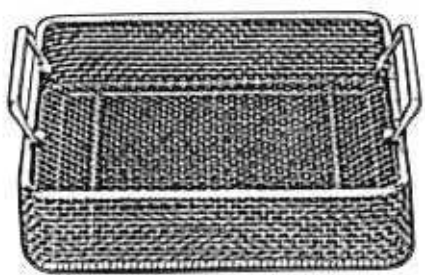

**MESH BASKET**  
**Z-35-358-001** 240 x 258 x 50 mm  
**Z-35-359-002** 250 x 240 x 100 mm  
**Z-35-360-003** 240 x 250 x 60mm

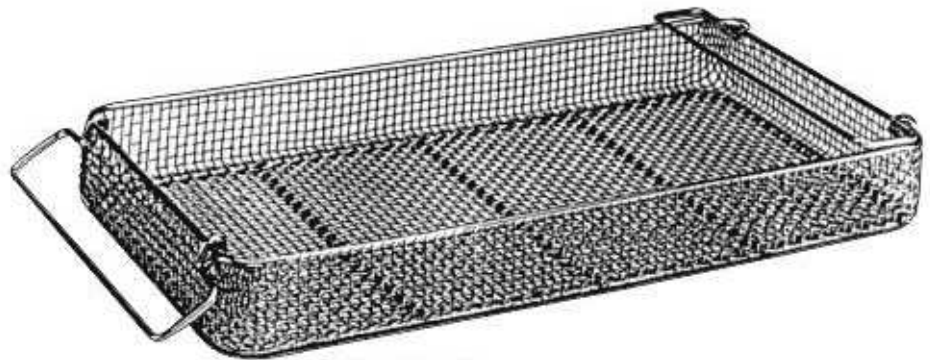

**MESH BASKET**  
**Z-35-361-001** 480 x 258 x 50 mm  
**Z-35-362-002** 480 x 258 x 100 mm  
**Z-35-363-003** 520 x 258 x 60mm  
**Z-35-364-004** 520 x 258 x 70mm  
**Z-35-365-005** 450 x 340 x 70mm  
**Z-35-366-006** 320 x 230 x 70mm

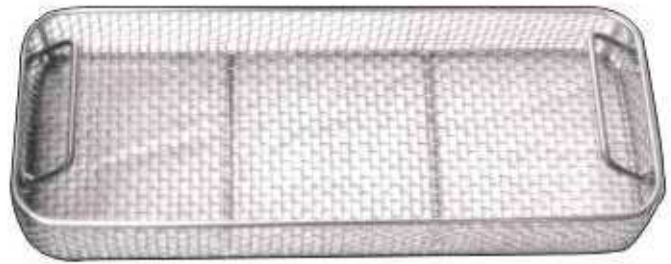

**MESH BASKET**  
 With Perforated Sheet Side  
**Z-35-367-001** 230 x 130 x 50 mm  
**Z-35-368-002** 230 x 130 x 60 mm  
**Z-35-369-003** 240 x 130 x 50 mm  
**Z-35-370-004** 240 x 130 x 60 mm  
**Z-35-371-005** 240 x 250 x 50 mm  
**Z-35-372-006** 240 x 250 x 60 mm  
**Z-35-373-007** 480 x 250 x 50 mm  
**Z-35-374-008** 480 x 250 x 60 mm  
**Z-35-375-009** 480 x 250 x 70 mm  
**Z-35-376-010** 300 x 300 x 50 mm  
**Z-35-377-011** 350 x 350 x 60 mm  
**Z-35-378-012** 470 x 400 x 60 mm  
**Z-35-379-013** 480 x 480 x 50 mm  
**Z-35-380-014** 480 x 480 x 60 mm  
**Z-35-381-015** 500 x 300 x 50 mm  
**Z-35-382-016** 520 x 300 x 50 mm  
**Z-35-383-017** 520 x 300 x 60 mm  
**Z-35-384-018** 550 x 430 x 50 mm  
**Z-35-385-019** 600 x 300 x 60 mm

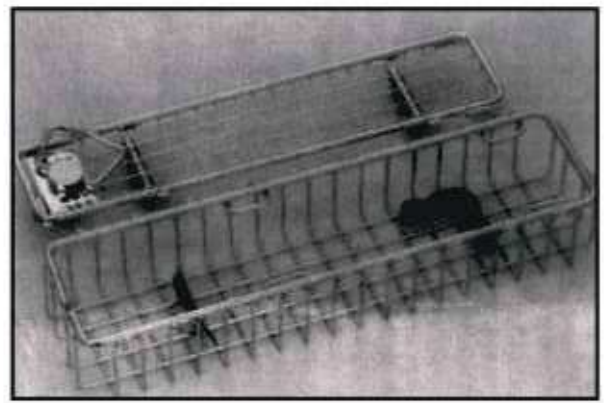

**ARTHROSCOPE BASKET**  
**Z-35-386-001** 290 x 80 x 52 mm

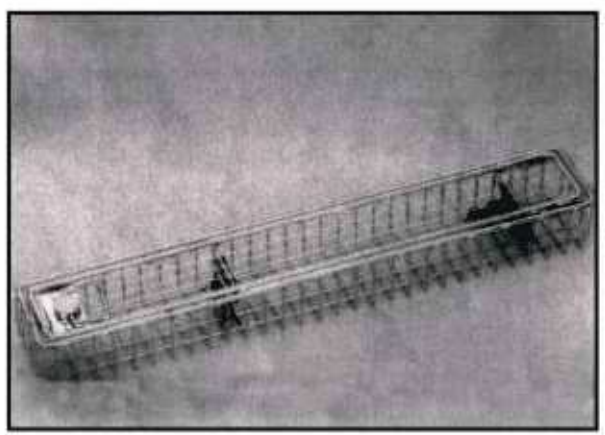

**ENDOSCOPE BASKET**  
**Z-35-387-001** 460 x 80 x 52 mm  
**Z-35-388-002** 660 x 80 x 52 mm  
**Z-35-389-003** 670 x 80 x 52 mm



**DAVIS**  
Z-35-390-160 16 cm, 6 1/4"  
Z-35-391-200 20 cm, 8"  
Z-35-392-240 24 cm, 9 1/2"

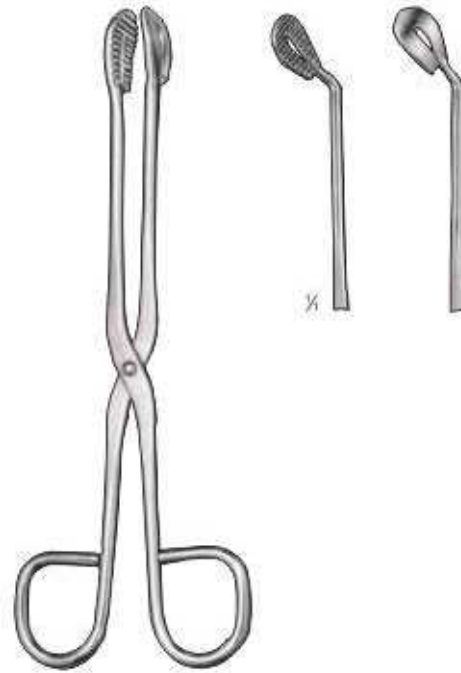

**UTILITY**  
Z-35-393-200 20 cm, 8"  
Z-35-394-280 28 cm, 11"



Z-35-395-200 20 cm, 8"  
Z-35-396-250 25 cm, 10"  
Z-35-397-300 30 cm, 11 3/4"



**ROGGE**  
Z-35-398-270  
27 cm, 11"



**CHEATEL**  
Box Joint  
Z-35-399-270  
27 cm, 11"



**CHEATEL**  
Screw Joint  
Z-35-400-270  
27 cm, 11"

**SURGICAL  
INSTRUMENT SETS**

---

## MAJOR BASIC SET

QTY .	DESCRIPTION	
2 each	MAYO DISSECTING SCISSORS, STRAIGHT	6 3/4"
1 each	MAYO DISSECTING SCISSORS, CURVED	5 1/2"
2 each	MAYO DISSECTING SCISSORS, CURVED	6 3/4"
12 each	HALSTED MOSQUITO FORCEPS, CURVED	5"
6 each	KELLY FORCEPS, STRAIGHT	5 1/2"
18 each	KELLY FORCEPS, CURVED	5 1/2"
18 each	ROCHESTER-PEN FORCEPS, CURVED	6 1/4"
6 each	ROCHESTER-PEN FORCEPS, CURVED	7 1/4"
12 each	ROCHESTER-OCHSNER FORCEPS, STRAIGHT	6 1/4"
2 each	DRESSING FORCEPS, SERRATED	5 1/2"
1 each	DRESSING FORCEPS, SERRATED	8"
2 each	TISSUE FORCEPS 1 X 2 TEETH	5 1/2"
1 each	TISSUE FORCEPS 1 X 2 TEETH	8"
2 each	CRILE-WOOD T.C. NEEDLE HOLDERS	6"
2 each	MAYO-HEGAR T.C.NEEDLE HOLDERS	7"
2 each	MAYO-HEGAR T.C.NEEDLE HOLDERS	8"
1 each	METZENBAUM SCISSORS, CURVED	5 3/4"
1 each	WIRE SCISSORS, ANGULAR	4 3/4"
1 each	DIRECTOR AND TONGUE TIE, PROBE END	6"
1 each	PROBE, W/ EYE	6"
1 each	OCHSNER TROCER, 20 FR	
1 each	POOLE SUCTION TUBE, ANGULAR, 23 FR	
1 each	POOLE SUCTION TUBE, STRAIGHT, 30 FR	
4 each	BABCOCK FORCEPS	6 1/4"
4 each	BABCOCK FORCEPS	7 3/4"
12 each	ALLIS FORCEPS, 4 X 5 TEETH	6"
4 each	ALLIS FORCEPS, 6 X 7 TEETH	7 1/2"
1 each	U.S. ARMY RETRACTOR, DOUBLE ENDED, SET OF 2	
2 each	PARKER RETRACTORS, D.E, SET OF 2	5/8" X 5"
6 each	KELLY RETRACTORS, MEDIUM	
1 each	RICHARSON RETRACTORS, MEDIUM	
1 each	RICHARSON-EASTMAN RETRACTOR, SMALL	
1 each	RICHARSON-EASTMAN RETRACTOR, LARGE	
1 each	DEAVER RETRACTOR	1" X 12"
1 each	DEAVER RETRACTOR	2" X 12"
2 each	DEAVER RETRACTOR	3" X 12"
2 each	MALLEABLE RETRACTOR	1 1/2" X 13"
2 each	VOLKMAN RETRACTOR, SHARP POINTS, 4 PROG	
1 each	BALFOUR RETRACTOR	
12 each	METZENBAUM SCISSORS, CURVED	7"
8 each	BACKHAUS TOWEL CLAMP	5 1/4"
1 each	SPONGE FORCEPS, STRAIGHT, SERRATED	9 1/2"
1 each	DEAVER RETRACTOR	1" X 9 12"
1 each	DEAVER RETRACTOR	1" X 13"
1 each	DEAVER RETRACTOR	1" X 14 1/2"
1 each	DEAVER RETRACTOR	1 1/2" X 12"

**MAJOR BASIC SET**

QTY .	DESCRIPTION	
1 each	MAYO DISSECTING SCISSORS, STRAIGHT.....	5"
1 each	MAYO DISSECTING SCISSORS, CURVED.....	5 ½"
12 each	HALSTED MOSQUITO FORCEPS, CURVED.....	5"
6 each	KELLY FORCEPS, STRAIGHT.....	5 ½"
12 each	KELLY FORCEPS, CURVED.....	5 ½"
6 each	ROCHESTER-OCHSNER FORCEPS, STRAIGHT.....	6 1/4"
1 each	DRESSING FORCEPS, SERRATED.....	4 ½"
1 each	DRESSING FORCEPS, SERRATED.....	5 ½"
1 each	TISSUE FORCEPS 1 X 2 TEETH.....	4 ½"
1 each	TISSUE FORCEPS 1 X 2 TEETH.....	5 ½"
2 each	CRILE-WOOD T.C. NEEDLE HOLDERS.....	6"
2 each	MAYO-HEGAR T.C.NEEDLE HOLDERS.....	7"
1 each	METZENBAUM SCISSORS, CURVED.....	5 3/4"

**INTESTINAL INSTRUMENT SET**

USED WITH MAJOR BASIC SET

QTY .	DESCRIPTION	
1 each	DRESSING FORCEPS.....	10"
2 each	MAYO-HEGAR NEEDLE HOLDER.....	7"
1 each	PAYR PYLORUS CLAMP.....	5 3/4"
6 each	PERCY INTESTINAL FORCEPS.....	6"
6 each	BABCOCK INTESTINAL FORCEPS.....	7 3/4"
3 each	ALLIS TISSU FORCEPS, 5 X 6 TEETH.....	7 3/4"
2 each	PEAN G.I. FORCEPS, STRAIGHT.....	9"
2 each	PEAN G.I. FORCEPS, CURVED.....	9"
2 each	ALLEN INTESTINAL CLAMPS, STRAIGHT.....	8"
2 each	DOYEN FORCEPS, STRAIGHT.....	8 3/4"
2 each	DOYEN FORCEPS.CURVED.....	8 3/4"
1 each	PAYR PYLORUS CLAMP.....	8"
1 each	PAYR PYLORUS CLAMP.....	11"
1 each	PAYR PYLORUS CLAMP.....	13 3/4"
1 each	DEAVER RETRACTOR.....	2"+12"
2 each	SPONGE FORCEPS, STRAIGHT, SERRATED.....	9 ½"

**CAESAREAN SECTION SET**

USED WITH MAJOR BASIC SET

QTY .	DESCRIPTION	
1 each	BANDAGE SCISSORS.....	7 1/4"
8 each	PENNINGTON CLAMPS, STRAIGHT.....	5 3/4"
1 each	DELEE O.B. FORCEPS,SHORT.....	12"



## GALL BLADDER SET

QTY .	DESCRIPTION	USED WITH MAJOR BASIC SET
2 each	CRILE- WOOD NEEDLE HOLDER .....	7"
1 each	MAYO CYSTIC DUCT SCOOP	
1 each	MAYO COMMON DUCT SCOOP, SMALL	
1 each	MAYO COMMON DUCT SCOOP, MEDIUM	
1 each	MAYO COMMON DUCT SCOOP, LARGE	
4 each	BAKES COMMON DUCT DILATORS, 3MM-11 MM, SET OF 9	
4 each	JOHNS HOPKINS GALL BLADDER FORCEPS .....	8"
6 each	LAHEY GALL DUCT FORCEPS .....	7 1/2"
1 each	LAHEY GALL DUCT FORCEPS .....	9"
1 each	GREY CYSTIC DUCT FORCEPS, WITHOUT TEETH, SET OF 2	
1 each	GREY-CYSTIC DUCT FORCEPS, WITH TEETH, SET OF 2	
1 each	BLAKE GALL STONE FORCEPS. CURVED .....	8"
1 each	DESJARDIN GALL STONE FORCEPS .....	9 1/2"
1 each	OCHSNER TROCAR. SIZE 16 (FOR 12 FR. CATHETER)	
1 each	OCHSNER TROCAR. SIZE 20 (FOR 16 FR. CATHETER)	
1 each	OCHSNER TROCAR, SIZE 22 (FOR 18 FR. CATHETER)	
1 each	POOLE SUCTION TUBE. ANGULAR, 23 FR.	
3 each	ALLIS FORCEPS, 5*6 TEETH .....	7 3/4"
8 each	PEAN FORCEPS, CURVED .....	9"
1 each	NELSON-METZENBAUM SCISSORS, CURVED .....	9"
2 each	SPONGE FORCEPS. STRAIGHT. SERRATED .....	9 1/2"
4 each	PEANUT SPONGE FORCEPS, STRAIGHT, SERRATED .....	9 1/2"

## THYROIDECTOMY SET

QTY .	DESCRIPTION	
24 each	PROVIDENCE HOSPITAL FORCEPS, STRAIGHT .....	5 1/2"
24 each	PROVIDENCE HOSPITAL FORCEPS, CURVED .....	5 1/2"
6 each	LAHEY GOITER FORCEPS .....	6 1/4"
4 each	MASTIN MUSCLE CLAMPS .....	6 3/4"
2 each	LAHEY RETRACTOR .....	7 3/4"
1 each	GREEN RETRACTOR .....	8 1/2"

## VAGOTOMY SET

QTY .	DESCRIPTION	
2 each	DRESSING FORCEPS, SERRATED .....	12"
2 each	MASSON NEEDLE HOLDERS. T.C JAW .....	10 1/2"
2 each	LOWER GALL DUCT FORCEPS .....	7"
2 each	LAHEY GALL DUCT FORCEPS .....	7 1/2"
6 each	ALLIS FORCEPS, 5*6 TEETH .....	6"
1 each	MAYO DISSECTING SCISSORS. CURVED .....	9"
1 each	NELSON-MEZTENBAUM THORACIC SCISSORS. CVD .....	9"
1 each	NELSON-MEZTENBAUM THORACIC SCISSORS. STR .....	9"
1 each	PARKER-MOTT RETRACTORS. DOUBLE ENDED, SET OF 2	
2 each	DEAVER RETRACTOR .....	2" * 12"
2 each	GREEN RETRACTOR .....	8 1/2"
2 each	SPONGE FORCEPS. STRAIGHT. SERRATED .....	9 1/2"

**NEUROSURGICAL LAMINECTOMY INSTRUMENTS**

QTY.	DESCRIPTION	
1 each	CUSHING BRAIN FORCEPS, SERRATED	7"
1 each	CUSHING BRAIN FORCEPS. W/MOUSE TEETH	7"
2 each	ADSON BRAIN FORCEPS, W/MOUSE TEETH	4 3/4"
2 each	ADSON BRAIN FORCEPS, SERRATED	4 3/4"
1 each	ADSON FORCEPS. BAYONET. SERRATED	7 1/2"
1 each	SMITHWICK CLIP APPLYING FORCEPS	10 1/2"
1 each	SWEET CLIP APPLYING FORCEPS	9 1/4"
1 each	SWEET CLIP APPLYING FORCEPS	11"
1 each	STRULLY SCISSORS, CURVED	8 3/4"
2 each	SENN RETRACTORS, DOUBLE ENDED. SHARP	6 1/4"
10 each	BACKHAUS TOWEL CLAMP	5 1/2"
8 each	SPONGE FORCEPS, STRAIGHT, SERRATED	9 1/2"
1 each	YABKAUER SUCTION TUBE	
2 each	OPERATING SCISSORS, STRAIGHT, SHARP/BLUNT	5 1/2"
2 each	MAYO DISSECTING SCISSORS, STRAIGHT	5 1/2"
2 each	MAYO DISSECTING SCISSORS, STRAIGHT	6 3/4"
2 each	MAYO DISSECTING SCISSORS, CURVED	5 1/2"
2 each	MAYO DISSECTING SCISSORS, CURVED	6 3/4"
24 each	CRILE FORCEPS, CURVED	5 1/2"
2 each	CRILE-WOOD NEEDLE HOLDERS, T.C. JAW	6"
1 each	SUTURE WIRE CUTTING SCISSORS, ANGULAR	
1 each	GROOVED DIRECTOR	6"
2 each	PROBES, W/EYE, SILVER	6"
12 each	ALLIS FORCEPS. 5X6 TEETH	7 3/4"
1 each	STILLE-LISTON BONE FORCEPS, STRAIGHT	10 1/2"
1 each	STILLE-LUER BONE RONGEUR, CURVED	8 1/2"
1 each	STILLE-LUER BONE RONGEUR, ANGULAR	9"
1 each	GERZOG BONE Mallet	
1 each	ARMY PATTERN OSTEOTOME, 6mm	
1 each	ARMY PATTERN OSTEOTOME, 12mm	
1 each	ARMY PATTERN OSTEOTOME, 18mm	
1 each	LANGENBECK ELEVATOR, NARROW	7 1/2"
1 each	LANGENBECK ELEVATOR, BROAD	7 1/2"
1 each	SAYRE ELEVATOR, BLUNT, DOUBLE ENDED	
1 each	CUSHING DECOMPRESSION RETRACTOR	8"
1 each	CUSHING NERVE AND VEIN RETRACTOR	9"
1 each	WEITLANER RETRACTOR, SHARP	6 1/2"
24 each	DANDY SCALP HEMOSTATS	5 1/2"
6 each	ADSON FORCEPS, STRAIGHT	7 1/4"
6 each	ADSON FORCEPS, CURVED	7 1/4"
1 each	ADSON DURA HOOK, SHARP	
1 each	FRAZIER BRAIN SUCTION TUBE, 6FR.	
4 each	GIGLI SAW, STILLE PATTERN	20"
1 each	HANDLES, SOLID, FOR GIGLI SAWS, IN PAIRS	

## CARDIAC ARREST SET

QTY .	DESCRIPTION	
1 each	MAYO DISSECTING SCISSORS, STRAIGHT.....	6 3/4"
1 each	MAYO DISSECTING SCISSORS, CURVED.....	6 3/4"
6 each	HALSTEAD MOSQUITO FORCEPS, STRAIGHT.....	5"
6 each	ROCHESTER-PEAN FORCEPS, CURVED.....	6 1/4"
1 each	DRESSING FORCEPS.....	6"
1 each	TISSUE FORCEPS, 1x2 TEETH.....	4 1/2"
1 each	MAYO-HEGER NEEDLE HOLDER, T.C. JAW.....	7"
2 each	ALLIS INTESTINAL FORCEPS, 4x5 TEETH.....	6"
4 each	BACKHAUS TOWEL CLAMP.....	5 1/2"
2 each	SPONGE FORCEPS, STRAIGHT, SERRATED.....	9 1/2"

## THORACIC AND CARDIOVASCULAR INSTRUMENTS

QTY .	DESCRIPTION	
2 each	YANKAUER SUCTION TUBES.....	6 3/4"
2 each	MAYO DISSECTING SCISSORS, STRAIGHT.....	6 3/4"
2 each	MAYO DISSECTING SCISSORS, CURVED.....	5"
36 each	HALSTEAD MOSQUITO FORCEPS, STRAIGHT.....	5"
36 each	HALSTEAD MOSQUITO FORCEPS, CURVED.....	6 1/4"
36 each	ROCHESTER-PEAN FORCEPS, CURVED.....	6 1/4"
18 each	ROCHESTER-OCHSNER FORCEPS, STRAIGHT.....	8"
12 each	ROCHESTER-OCHSNER FORCEPS, STRAIGHT.....	5 1/2"
36 each	CRILE FORCEPS, CURVED.....	5 1/2"
2 each	DRESSING FORCEPS, SERRATED.....	8"
2 each	DRESSING FORCEPS, SERRATED.....	10"
2 each	DRESSING FORCEPS, SERRATED.....	5 1/2"
2 each	TISSUE FORCEPS 1x2 TEETH.....	6"
1 each	RUSSIAN TISSUE FORCEPS.....	8"
2 each	RUSSIAN TISSUE FORCEPS.....	7"
2 each	CRILE-WOOD NEEDLE HOLDER.....	7"
2 each	MAYO-HEGAR NEEDLE HOLDER.....	8"
1 each	HEGAR NEEDLE HOLDER, T.C. JAW.....	10 1/2"
2 each	MASSON NEEDLE HOLDER, T.C. JAW.....	
1 each	SUTURE WIRE CUTTING SCISSORS, ANGULAR.....	6"
2 each	GROOVED DIRECTOR.....	6"
2 each	PROBES W/EYE, SILVER.....	
1 each	OCHSNER TROCAR, SIZE 20.....	6 1/4"
6 each	BABCOCK FORCEPS.....	7 3/4"
10 each	BABCOCK FORCEPS.....	9 1/4"
2 each	BABCOCK FORCEPS.....	6"
12 each	ALLIS FORCEPS, 5x6 TEETH.....	10"
10 each	ALLIS FORCEPS, 5x6 TEETH.....	9"
6 each	PEAN FORCEPS, STRAIGHT.....	10 1/2"
1 each	STILLE-LISTON BONE FORCEPS, CURVED.....	10 1/2"
1 each	STILLE-HORSLEY BONE FORCEPS, BAYONET.....	8 1/2"
1 each	STILLE-LUER BONE RONGEUR, CURVED.....	7 1/2"
1 each	POTTS-SMITH SCISSORS, 45 DEGREE ANGLE.....	7 1/4"
1 each	POTTS-SMITH SCISSORS, 60 DEGREE ANGLE.....	9 1/2"
2 each	POTTS-SMITH DRESSING FORCEPS, SERRATED.....	7"
1 each	POTTS-SMITH TISSUE FORCEPS, 1x2 TEETH.....	14"
1 each	BETHUNE RIB SHEARS.....	8 1/2"
1 each	STILLE RIB SHEARS.....	10"
1 each	LEBSCHKE STERNUM KNIFE.....	1 1/2"
2 each	MIXTER CLAMPS, CURVED.....	

**THORACIC AND CARDIOVASCULAR INSTRUMENTS**

QTY .	DESCRIPTION	
6 each	DUVAL LUNG GRASPING FORCEPS, 1" JAW	8"
1 each	MATSON RIB STRIPPER	8 3/4"
1 each	ALEXANDER COSTAL PERIOSTEOTOME	8 1/2"
1 each	DOYEN RIB RASPATORY AND ELEVATOR, RIGHT	6"
1 each	DOYEN RIB RASPATORY AND ELEVATOR, LEFT	6"
1 each	HARRINGTON SPLANCHNIC RETRACTOR, LARGE	12 1/2"
2 each	HIBBS RETRACTOR, BLADE	3" x 1"
1 each	DEAVER RETRACTOR	1" x 12"
1 each	DEAVER RETRACTOR	1" x 13"
2 each	DEAVER RETRACTOR	1 1/2" x 12"
2 each	RIBBON MALLEABLE RETRACTOR	1 1/2" x 13"
2 each	VOLKMAN RAKE RETRACTOR, 4 SPONG SHARP	
18 each	BACKHAUS TOWEL CLAMP	5 1/2"
18 each	SPONGE FORCEPS, SERRATED, STRAIGHT	9 1/2"
2 each	DEAVER RETRACTOR	2" x 12"
2 each	NELSON-MEZTENBAUM SCISSORS, CURVED	9"
2 each	NELSON-MEZTENBAUM SCISSORS, CURVED	11"
2 each	GREEN RETRACTOR	8 1/2"
1 each	PARKER RETRACTORS, SET OF 2	5" x 3/4"
2 each	LANGENBECK RETRACTOR	3/8" x 1 1/2"
2 each	DEAVER RETRACTOR, 1" BLADE	9 1/2"
1 each	ADSON FORCEPS, MOUSE TEETH	4 3/4"
1 each	ADSON FORCEPS, SERRATED	4 3/4"
1 each	SATINSKY VENA CAVA CLAMP	10 1/4"
1 each	POTTS-SMITH SCISSORS, 25 DEGREE ANGLE	7 1/2"
<b>TONSIL INSTRUMENT SET</b>		

QTY.	DESCRIPTION	
1 each	YANKAUER SUCTION TUBE	
1 each	MAYO-HEGAR NEEDLE HOLDER, T.C. JAW	6"
1 each	LAFORCE ADENOTOME, LARGE	
1 each	LAFORCE ADENOTOME, MEDIUM	
1 each	LAFORCE ADENOTOME, SMALL	
3 each	BLADES FOR LAFORCE ADENOTOME, LARGE	
3 each	BLADES FOR LAFORCE ADENOTOME, MEDIUM	
3 each	BLADES FOR LAFORCE ADENOTOME, SMALL	
1 each	BARNHILL ADENOID CURETTE, SIZE 1	
1 each	BARNHILL ADENOID CURETTE, SIZE 2	
2 each	LARYNGEAL MIRRORS, W/HANDLE, SIZE 4	
1 each	DENHARDT MOUTH GAG	
1 each	JENNINGS MOUTH GAG, LARGE	
1 each	JENNINGS MOUTH GAG, SMALL	
1 each	WIEDER TONGUE DEPRESSOR, SMALL	
3 each	FOERSTER SPONGE FORCEPS, SERRATED, CVD	7"
1 each	WHITE TONSIL FORCEPS, CURVED	9"
2 each	SCHNIDT TONSIL FORCEPS, HALF CURVED JAW	7 1/2"
1 each	BOETTCHER TONSIL SCISSORS, CURVED	7"
1 each	METZENBAUM SCISSORS, CURVED	7"
1 each	HURD DISSECTOR AND RETRACTOR	
1 each	ABRAHAM DOUBLE EDGED TONSIL KINFE	8"
1 each	FISHER TONSIL KNIFE, SERRATED EDGE	9"
1 each	BECK- SCHENCK TONSIL SNARE, COMPLETE	
1 each	TYDING TONSIL SNARE, COMPLETE	
2 each	BACKHAUS TOWEL CLAMP	5 1/4"

## TRACHEOTOMY SET

QTY.	DESCRIPTION	
1 each	OPERATING SCISSORS, STRAIGHT, S/B	5 1/2"
1 each	MAYO DISSECTING SCISSORS, CURVED	5 1/2"
6 each	HALSTEAD MOSQUITO FORCEPS, CURVED	5"
2 each	ROCHESTER-PEAN FORCEPS, CURVED	5 1/2"
10 each	CRILE FORCEPS, STRAIGHT	5 1/2"
2 each	DRESSING FORCEPS, SERRATED	5"
2 each	TISSUE FORCEPS, 2 x 3 TEETH	5 1/2"
1 each	CRILE-WOOD T.C. JAW NEEDLE HOLDER	6"
2 each	ALLIS FORCEPS, 4 x 5 TEETH	6"
1 each	METZENBAUM SCISSORS, CURVED	7"
1 each	TRACHEAL RETR. SHARP, 1 PRONG	
1 each	LABORDE DILATOR, TRI-VALVE	
4 each	BACKHAUS TOWEL CLAMP	5 1/2"
4 each	SPONGE FORCEPS, STRAIGHT, SERRATED	9 1/2"

## OBSTETRICAL FORCEPS

QTY .	DESCRIPTION	
2 each	DELEE FORCEPS, STANDARD	14"
1 each	SIMPSON FORCEPS, SHORT	12"
1 each	SIMPSON FORCEPS, LONG	14"
2 each	KIELAND LUIKART FORCEPS	15 3/4"
2 each	SIMPSON LUIKART FORCEPS	14"
1 each	PIPER FORCEPS	17 1/2"

## OBSTETRICAL INSTRUMENTS

QTY.	DESCRIPTION	
2 each	OPERATING SCISSORS, STRAIGHT, BLUNT/BLUNT	15 1/2"
6 each	MAYO SCISSORS, STRAIGHT 6 3/4"	6 3/4"
6 each	MAYO SCISSORS, CURVED	6 3/4"
12 each	HALSTEAD MOSQUITO FORCEPS, STRAIGHT	
1 each	HALSTEAD MOSQUITO FORCEPS, CURVED	
12 each	KELLY FORCEPS, STRAIGHT	
12 each	KELLY FORCEPS, CURVED	
12 each	ROCHESTER-PEAN FORCEPS, STRAIGHT	6 1/4"
12 each	DRESSING FORCEPS	6"
12 each	TISSUE FORCEPS, 2 x 3 TEETH	6"
4 each	MAYO-HEGAR NEEDLE HOLDERS, T.C. JAW	7"
4 each	MAYO-HEGAR NEEDLE HOLDERS, T.C. JAW	7"
2 each	PROBE W/EYE, SILVER	6"
12 each	ALLIS TISSUE FORCEPS, 5 x 6 TEETH	6"
24 each	BACKHAUS TOWEL CLAMP 5 1/4"	5 1/4"
24 each	SPONGE FORCEPS, STRAIGHT, SERRATED	9 1/2"
2 each	MAYO SCISSORS, CURVE	9"
2 each	JACKSON VAGINAL RETRACTORS, MEDIUM	
2 each	JACKSON VAGINAL RETRACTORS, SMALL	
1 each	AUVARD WEIGHTED SPECULUM, MEDIUM	
2 each	GELPI RETRACTOR	7"
2 each	GRAVES VAGINAL SPECULUM, SMALL	

**OBSTETRICAL INSTRUMENTS**

<b>QTY.</b>	<b>DESCRIPTION</b>
3 each	GRAVES VAGINAL SPECULUM, MEDIUM
2 each	GRAVES VAGINAL SPECULUM, LARGE
1 each	PEDERSON VAGINAL SPECULUM, NARROW
4 each	BOZEMAN UTERINE DRESSING FORCEPS, STR..... 10"
2 each	SCHROEDER UTERINE TENACULUM
2 each	IOWA MEMBRANE PUNCTURING FORCEPS
1 each	COLLYER PELVIMETER

**DILATON AND CURETTAGE SET**

<b>QTY .</b>	<b>DESCRIPTION</b>
1 each	OPERATING SCISSORS, STR., SHARP/BLUNT..... 5 1/2"
6 each	BACKHAUS TOWEL CLAMP..... 5 1/2"
4 each	SPONGE FORCEPS., SERRATED..... 9 1/2"
1 each	JACKSON RETRACTOR, LARGE BLADE..... 4" x 1 1/2"
1 each	JACKSON RETRACTOR, MEDIUM BLADE..... 3 1/2" x 1 1/2"
1 each	JACKSON RETRACTOR SMALL, BLADE..... .3" x 1 1/2"
1 each	SIMS RETRACTOR, DOUBLE ENDED, NO. 4
1 each	SIMS RETRACTOR, DOUBLE ENDED, NO. 6
1 each	AUVARD WEIGHTED SPECULUM, MEDIUM
1 each	GRAVES SPECULUM, MEDIUM
1 each	GOODELL UTERINE DILATOR, LARGE..... 13"
1 each	GOODELL UTERINE DILATOR, SMALL..... 11"
1 each	HEGAR DILATORS, SET OF 8
1 each	SIMS SOUND, PLAIN
1 each	SIMPSON SOUND, GRADUATED
1 each	SIMS CURETTE, SIZE 1, SHARP
1 each	SIMS CURETTE, SIZE 2
1 each	SIMS CURETTE, SIZE 3
1 each	SIMS CURETTE, SIZE 4
1 each	SIMS CURETTE, SIZE 5
1 each	SIMS CURETTE, SIZE 6
1 each	THOMAS UTERINE CURETTE, SIZE 1, BLUNT
1 each	THOMAS UTERINE CURETTE, SIZE 2
1 each	THOMAS UTERINE CURETTE, SIZE 3
1 each	THOMAS UTERINE CURETTE, SIZE 4
1 each	THOMAS UTERINE CURETTE, SIZE 5
1 each	THOMAS UTERINE CURETTE, SIZE 6
1 each	THOMS-GAYLOR BIOPSY FORCEPS, IMPROVED JAW..... 8 1/2"
1 each	BOZEMAN UTERINE DRESSING FORCEPS, CVD..... 10"
2 each	SCHROEDER TENACULUM..... 9"

**MISCELLANEOUS INSTRUMENTS**

<b>QTY .</b>	<b>DESCRIPTION</b>
1 each	FINGER RING CUTTER
1 each	FINGER NAIL DRILL W/THREE DRILLS
6 each	YANKAUER SUCTION TUBES

## MISCELLANEOUS INSTRUMENTS

QTY .	DESCRIPTION	
6 each	STERILIZER UTILITY FORCEPS, STRAIGHT	11"
12 each	LISTER BANDAGE SCISSORS	5 1/2"
6 each	LISTER BANDAGE SCISSORS	7 1/4"
6 each	OPERATING SCISSORS, STR., SHARP/SHARP	5 1/2"
12 each	OPERATING SCISSORS, STR., SHARP/BLUNT	5 1/2"
6 each	OPERATING SCISSORS, STR., BLUNT/BLUNT	5 1/2"
6 each	OPERATING SCISSORS, STR., SHARP/BLUNT	6 1/2"
6 each	MAYO DISSECTING SCISSORS, STRAIGHT	5 1/2"
12 each	MAYO DISSECTING SCISSORS, STRAIGHT	6 3/4"
12 each	MAYO DISSECTING SCISSORS, CURVED	5 1/2"
12 each	MAYO DISSECTING SCISSORS, CURVED	6 3/4"
24 each	HALSTEAD MOSQUITO FORCEPS, STRAIGHT	5"
48 each	HALSTEAD MOSQUITO FORCEPS, CURVED	5"
24 each	ROCHESTER-PEAN FORCEPS, CURVED	7 1/4"
24 each	CRILE FORCEPS, STRAIGHT	5 1/2"
12 each	CRILE FORCEPS, CURVED	5 1/2"
1 each	DRESSING FORCEPS, SERRATED	5 1/2"
12 each	VIRTUS SPLINTER FORCEPS	6"
12 each	BAUMGARTNER NEEDLE HOLDERS, T.C. JAW	5 1/2"
6 each	MAYO-HEGAR NEEDLE HOLDER, T.C. JAW	6"
6 each	MAYO-HEGAR NEEDLE HOLDER, T.C. JAW	7"
12 each	MAYO-HEGAR NEEDLE HOLDER, T.C. JAW	8"
12 each	METZENBAUM SCISSORS, CURVED	5 3/4"
2 each	ADSON FORCEPS, SERRATED	4 3/4"
4 each	MALLEABLE RETRACTOR	1" X 13"
2 each	MALLEABLE RETRACTOR	1 3/4" x 13"
2 each	MALLEABLE RETRACTOR	2" x 13"
2 each	VOLKMAN RETRACTOR, BLUNT, 2 PRONG	
2 each	VOLKMAN RETRACTOR, BLUNT, 4 PRONG	
2 each	VOLKMAN RETRACTOR, BLUNT, 6 PRONG	
6 each	STRABISMUS SCISSORS, STRAIGHT	4 1/4"
6 each	STRABISMUS SCISSORS, CURVED	4 1/4"
6 each	IRIS SCISSORS, CURVED	4 1/2"
6 each	IRIS SCISSORS, STRAIGHT	4 1/2"
1 each	COAKLEY CURETTE, SET OF 6	
1 set	VAN BUREN SOUNDS, SET OF 12, SIZES 8-30 FR.	
1 each	JONES TOWEL CLAMP, CROSS ACTION	3"
12 each	SPONGE FORCEPS, STRAIGHT, SERRATED	9 1/2"
12 each	SPONGE FORCEPS, STRAIGHT, SERRATED	7"
6 each	GRAVES SPECULUM, SMALL	
1 each	GRAVES SPECULUM, MEDIUM	
6 each	GRAVES SPECULUM, LARGE	
6 each	SUTURE WIRE CUTTING SCISSORS, ANGULAR	
2 each	OCHSNER GALL BLADDER TROCAR, 14 FR.	
2 each	OCHSNER GALL BLADDER TROCAR, 20 FR.	
2 each	OCHSNER GALL BLADDER TROCAR, 24 FR.	
24 each	BACKHAUS TOWEL CLAMP	3 1/2"
36 each	BACKHAUS TOWEL CLAMP	5 1/2"
12 each	ADSON FORCEPS, MOUSE TEETH	4 3/4"
2 each	PEDERSON SPECULUM, SMALL	3 1/2" x 7 1/2"
6 each	BOZEMAN UTERINE DRESSING FORCEPS, CVD	10"

**PELVIC SET**

USED WITH MAJOR BASIC SET	
QTY.	DESCRIPTION
1 each	MAYO DISSECTING SCISSORS, STRAIGHT..... 6 3/4"
1 each	MAYO DISSECTING SCISSORS, CURVED..... 6 3/4"
12 each	KELLY FORCEPS, CURVED..... 5 1/2"
10 each	OCHSNER FORCEPS, CURVED..... 8"
6 each	OCHSNER FORCEPS, STRAIGHT..... 6 1/4"
6 each	OCHSNER FORCEPS, STRAIGHT..... 8"
1 each	DRESSING FORCEPS..... 6"
1 each	TISSUE FORCEPS, 1 x 2 TEETH..... 6"
2 each	MASSON NEEDLE HOLDER, T.C. JAW..... 10 1/2"
6 each	PEAN FORCEPS, CURVED..... 9"
6 each	PEAN FORCEPS, CURVED..... 10"
4 each	BACKHAUS TOWEL CLAMP..... 5 1/2"
2 each	SPONGE FORCEPS, STRAIGHT, SERRATED..... 9 1/2"
6 each	HEANEY-BALLANTINE HYSTERECTOMY FORCEPS, CVD..... 8"
2 each	HEANEY NEEDLE HOLDERS, T.C. JAWS..... 8 1/4"
1 each	SCHROEDER TENACULUM..... 9"
1 each	SCHROEDER VULSELLUM FORCEPS, STRAIGHT..... 9"

**PLASTIC SET**

QTY .	DESCRIPTION
1 each	MAYO DISSECTING SCISSORS, STRAIGHT..... 5 1/2"
1 each	MAYO DISSECTING SCISSORS, CURVED..... 5 1/2"
6 each	HALSTEAD MOSQUITO FORCEPS, STRAIGHT..... 5"
12 each	HALSTEAD MOSQUITO FORCEPS, CURVED..... 5"
4 each	ROCHESTER-OCHSNER FORCEPS, STRAIGHT..... 5 1/2"
2 each	CRILE-WOOD NEEDLE HOLDER..... 6"
2 each	BAUMGARTNER NEEDLE HOLDERS..... 5"
4 each	ALLIS FORCEPS, 4 x 5 TEETH..... 6"
4 each	SENN RETRACTOR, SHARP
1 each	STEVENS TEOTOMOY SCISSORS, CVD., BLUNT
1 each	STEVENS TEOTOMOY SCISSORS, STR., BLUNT
1 each	VIENNA NASAL SPECULUM, ADULT
6 each	BACKHAUS TOWEL CLAMP..... 3 1/2"

**BASIC ORTHOPEDIC SET**

QTY.	DESCRIPTION
2 each	MAYO DISSECTING SCISSORS, STRAIGHT..... 5 1/2"
1 each	MAYO DISSECTING SCISSORS, STRAIGHT..... 6 3/4"
2 each	MAYO DISSECTING SCISSORS, CURVED..... 5 1/2"
1 each	MAYO DISSECTING SCISSORS, CURVED..... 6 3/4"
12 each	ROCHESTER-PEAN FORCEPS, CURVED..... 6 1/4"
10 each	ROCHESTER-OCHSNER FORCEPS, STRAIGHT..... 6 1/4"
18 each	CRILE FORCEPS, CURVED..... 5 1/2"



## BASIC ORTHOPEDIC SET

QTY .	DESCRIPTION	
2 each	DRESSING FORCEPS, SERRATED.....	5 1/2"
2 each	TISSUE FORCEPS, 1 x 2 TEETH.....	5 1/2"
1 each	CRILE-WOOD NEEDLE HOLDER, T.C. JAW.....	6"
2 each	MAYO-HEAGAR NEEDLE HOLDER, T.C. JAW.....	7"
1 each	SUTURE WIRE CUTTING SCISSORS, ANGULAR.....	4 3/4"
1 each	GROOVED DIRECTOR.....	6"
2 each	PROBES, W/EYE, SILVER.....	6"
10 each	ALLIS FORCEPS, 5 x 6 TEETH.....	6"
1 each	LANE SCREW DRIVER	
1 each	VAN BUREN SEQUESTERUM FORCEPS, BAYONET.....	8 1/2"
1 each	LANE BONE HOLDING FORCEPS, W/RATCHET.....	13"
1 each	KERN BONE HOLDING FORCEPS, W/RATCHET.....	8 1/2"
1 each	LAMBOTTE BONE FORCEPS.....	8 3/4"
1 each	LOWMAN CLAMP, LARGE	
1 each	LOWMAN CLAMP, LARGE	
1 each	LISTON BONE CUTTING FORCEPS, STRAIGHT.....	7 3/4"
1 each	STILLE-LISTON BONE FORCEPS, STRAIGHT.....	10 1/2"
1 each	STILLE-LISTON BONE FORCEPS, CURVED.....	10 1/2"
1 each	STILLE-LUER BONE RONGEUR, STRAIGHT.....	8 1/2"
1 each	STILLE-LUER BONE RONGEUR, ANGULAR.....	9"
2 each	GIGLI BONE SAWS, STILLE PATTERN.....	12"
2 each	GIGLI BONE SAWS, STILLE PATTERN.....	20"
2 each	GIGLI BONE SAWS, STILLE PATTERN.....	30"
1 pair	HANDLES FOR GIGLI SAW, SOLID	
1 each	SAYRE ELEVATOR, SHARP DOUBLE ENDED.....	6 1/2"
1 each	MURPHY BONE SKID, DOUBLE ENDED.....	12"
1 each	BONE FILE.....	9 1/2"
2 each	HIBBS RETRACTOR, BLADE 3" x 1" LENGTH.....	9 1/4"
2 each	GREEN RETRACTOR.....	8 1/2"
1 each	MAYO-COLLINS RETRACTOR, SET OF 2	
1 each	PARKER RETRACTOR, SET OF 2	
2 each	LANGENBECK RETRACTOR, MEDIUM	
2 each	VOLKMAN RETRACTOR, BLUNT, 4 PRONG.....	8 1/2"
1 each	LUCAE BAYONET FORCEPS.....	5 1/2"
1 each	METZENBAUM SCISSORS, CURVED.....	7"
10 each	BACKHAUS TOWER CLAMP.....	5 1/2"
8 each	SPONGE FORCEPS, STR., SERRATED.....	9 1/2"
1 each	VOLKMAN BONE CURETTES, OVAL, # 000.....	6 3/4"
1 each	VOLKMAN BONE CURETTES, OVAL, # 00.....	6 3/4"
1 each	VOLKMAN BONE CURETTES, OVAL, # 0.....	6 3/4"
1 each	VOLKMAN BONE CURETTES, OVAL, # 1.....	6 3/4"
1 each	VOLKMAN BONE CURETTES, OVAL, # 2.....	6 3/4"
1 each	VOLKMAN BONE CURETTES, OVAL, # 3.....	6 3/4"
1 each	VOLKMAN BONE CURETTES, OVAL, # 4.....	6 3/4"
1 each	VOLKMAN BONE CURETTES, OVAL, # 5.....	6 3/4"
1 each	VOLKMAN BONE CURETTES, OVAL, # 6.....	6 3/4"

**POST MORTEM INSTRUMENTS**

<b>QTY.</b>	<b>DESCRIPTION</b>	
1 each	STERILIZER UTILITY FORCEPS, STRAIGHT.....	11"
1 each	OPERATING SCISSORS, STRAIGHT, S/S.....	5"
1 each	MAYO DISSECTING SCISSORS, STRAIGHT.....	6 3/4"
1 each	MAYO DISSECTING SCISSORS, CURVED.....	6 3/4"
1 each	DRESSING FORCEPS, SERRATED.....	6"
1 each	TISSUE FORCEPS, 1 x 2 TEETH.....	6"
1 each	TISSUE FORCEPS, 1 x 2 TEETH.....	10"
1 each	PROBE, W/EYE.....	10"
1 each	LANGENEACK METACARPAL SAW.....	4 1/2"
1 each	GLUCK RIB SHEARS.....	8 3/4"
1 each	MAYO DISSECTING SCISSORS, STRAIGHT.....	9"
1 each	CARTILAGE KNIFE, BLADE.....	6 1/2"
1 each	VIRCHOW KNIFE, BLADE.....	3 1/2"
1 each	SUTURE WIRE SCISSORS, ANGULAR.....	4 3/4"
1 each	DIRECTOR AND TONGUE TIE.....	6"
8 each	ALLIS FORCEPS, 4 x 5 TEETH.....	6"
2 each	GREEN RETRACTOR.....	8 1/2"
1 each	PARKER RETRACTOR, D.E., SET OF 2.....	7 1/8" x 7"
2 each	RICHARDSON RETRACTOR, SMALL.....	
2 each	VOLKMAN RETRACTORS, SHARP, 4 PRONG.....	
2 each	SENN D.E., RETRACTOR.....	6 1/4"
1 each	ALM RETRACTOR.....	2 3/4"
1 each	METZENBAUM SCISSORS, CURVED.....	5 3/4"
12 each	BACKHAUS TOWEL CLAMP.....	5 1/4"
8 each	SPONGE FORCEPS, STRAIGHT SERRATED.....	9 1/2"

**NEPHRECTOMY SET**

<b>QTY .</b>	<b>DESCRIPTION</b>	
USED WITH MAJOR BASIC SET		
8 each	ROCHESTER-PEAN FORCEPS, CURVED.....	8"
8 each	ROCHESTER-OCHSNER FORCEPS, STRAIGHT.....	8"
2 each	DRESSING FORCEPS, SERRATED.....	10"
2 each	MASSON NEEDLE HOLDER, T.C. JAW.....	10 1/2"
2 each	LOWER GALL DUCT FORCEPS.....	7"
1 set	GREY CYSTIC DUCT FORCEPS, W/O TEETH, SET OF 2.....	
1 each	BLAKE GALL STONE FORCEPS, CURVED.....	8 1/4"
1 each	DESJARDIN GALL STONE FORCEPS.....	9 1/4"
1 each	RANDALL KIDNEY STONE FORCEPS, NO.1.....	
1 each	RANDALL KIDNEY STONE FORCEPS, NO.2.....	
1 each	RANDALL KIDNEY STONE FORCEPS, NO.3.....	
1 each	RANDALL KIDNEY STONE FORCEPS, NO.4.....	
2 each	HERRICK KIDNEY CLAMP.....	9"
1 each	OCHSNER TROCAR, SIZE 20 FR.....	
2 each	DEAVER RETRACTOR.....	2" x 12"
1 each	METZENBAUM SCISSORS, CURVED.....	7"
1 each	BOZEMAN DRESSING FORCEPS, CURVED.....	10"

## VENOUS SECTION SET

QTY .	DESCRIPTION	
1 each	OPERATING SCISSORS, STR., SHARP/BLUNT	5 1/2"
2 each	HALSTEAD MOSQUITO FORCEPS, STRAIGHT	5"
2 each	HALSTEAD MOSQUITO FORCEPS, CURVED	5"
1 each	DRESSING FORCEPS, SERRATED	5 1/2"
1 each	CRILE-WOOD NEEDLE HOLDER, T.C. JAW	6"
1 each	ADSON TISSUE FORCEPS, W/MOUSE TEETH	
4 each	BACKHAUS TOWEL CLAMP	5 1/4"

## RECTAL INSTRUMENT SET

QTY.	DESCRIPTION	
1 each	OPERATING SCISSORS, STR., SHARP/BLUNT	5 1/2"
1 each	MAYO DISSECTING SCISSORS, STRAIGHT	6 3/4"
1 each	MAYO DISSECTING SCISSORS, CURVED	6 3/4"
8 each	ROCHESTER-PEAN FORCEPS, CURVED	6 1/2"
8 each	ROCHESTER-OCHSNER FORCEPS, CURVED	6 1/2"
6 each	PENNINGTON CLAMP, STRAIGHT	5 3/4"
8 each	CRILE FORCEPS, STRAIGHT	5 1/2"
2 each	DRESSING FORCEPS, SERRATED	6"
2 each	TISSUE FORCEPS, 1 x 2 TEETH	6"
2 each	MAYO-HEGAR NEEDLE HOLDER, T.C. JAW	7"
1 each	SUTURE WIRE SCISSORS, ANGULAR	4 1/4"
1 each	GROOVED DIRECTOR	6"
2 each	PROBE, W/EYE, SILVER	6"
4 each	ALLIS FORCEPS, 5 x 6 TEETH	7 3/4"
1 each	BUIE PILE CLAMP	8 1/4"
6 each	PRATT "T" SHAPED FORCEPS	5 1/2"
1 each	SMITH ANAL RETRACTOR	
1 each	SIM SPECULUM, FENESTRATED BLAD.E	
1 each	HIRSCHMAN ANASCOPE, SMALL	
1 each	HIRSCHMAN ANASCOPE, MEDIUM	
1 each	HIRSCHMAN ANASCOPE, LARGE	
6 each	BACKHAUS TOWEL CLAMP	5 1/2"
6 each	FOERSTER SPONGE FORCEPS, STRAIGHT, SERR.	9 1/2"

## NORMAL DELIVERY SET

QTY .	DESCRIPTION
1 each	LARGE BOWEL
2 each	SIM,S SPACULLM (SMALL, LARGE)
1 each	EPISOTOMY SCISSOR
1 each	NON TOOTHED FORCEPS
2 each	ARTERY FORCEPS STRAIGHT (SMALL, LARGE)
2 each	ARTERY FORCEPS CURVED
3 each	SPONG HOLDING FORCEPS
1 each	NEEDLE HOLDER MEDIUMSIZE
1 each	KIDNEY TRAY BIG SIZE
2 each	KIDNEY TRAY SMALL SIZE

**D&C SET**

<b>QTY .</b>	<b>DESCRIPTION</b>
1 each	INSTRUMENT TRAY
2 each	BOWEL SMALL AND MEDIUM
2 each	SIM,S SPACULUM
3 each	SPONG HOLDER
12 each	DILATOR SET IN ALL SIZE
1 each	MATALIC CATHETER
1 each	B.P HANDLE NO 3
1 each	TISSUE SCISSOR
3 each	SUCTION CURETTE
3 each	CURETT WITH HANDLE SMALL, MEDIUM, LARGE
2 each	TOOTHED AND NON TOOTHED FORCEPS
2 each	COMPLETE SET OF CURETTE
1 each	WALL, SPACULUM FORCEPS

**MICRO SURGERY SET (MAJOR SET)**

complete set includes one each of the following:

<b>QTY .</b>	<b>DESCRIPTION</b>	
1 each	MICRO TYING FORCEPS	4 3/8" 0.3mm tip
1 each	BARRAQUER NEEDLE HOLDER	5" curved, with lock
1 each	MICRO SCISSORS	5" straight 1x2 teeth
1 each	GRAEFE IRIS FORCEPS	4" straight 1x2 teeth
1 each	MICRO CLAMPS APPLICATOR	5 1/2"
1 each	APPROXIMATION CLAMP	without suture holding frame
1 each	MICRO SCISSORS (REILL)	5 1/2" curved, serrated
1 each	PLATFORM TYING FORCEPS	5 1/2" 0.7mm tip
1 each	HEPP-SCHEIDEL DISSECTING SCISSORS	5 1/2" curved
1 each	CLAMP BOX	for micro clamps
1 each	STERILIZATION AND INSTRUMENT CASE	for eight piece micro set
1 each	INSTRUMENTS RACK	for eight piece micro set

**MICRO SURGERY SET (MINI SET)**

<b>QTY .</b>	<b>DESCRIPTION</b>	
1 each	PLATFORM TYING FORCEPS	5 1/2" 0.7mm tip
1 each	BARRAQUER NEEDLE HOLDER	5" curved with lock
1 each	MICRO SCISSORS	5" curved, long blade, round handle
1 each	STERILIZATION AND INSTRUMENT CASE	for three piece micro set

# ***Index***

# INDEX

DESCRIPTION	PAGE #	DESCRIPTION	PAGE #
<b>A</b>			
Abadie Intestinal Clamp Forceps .....	346	Arruga Needle Holders .....	170, 171
Abdominal Retractors .....	286, 373	Arthroscope Basket .....	568
Abraham Knives .....	33	Articulated Tension Device .....	425
Abraham Tonsil Holding Forceps.....	541	Asch Septum Forceps .....	530
Adlerkreutz Tissue Forceps .....	99	Atraumatic Dressing Forceps .....	108
Adson / Micro-adson Tissue & Dressing Forceps .....	106	Aufranc Retractor .....	466
Adson Bone Rongeurs .....	481	Aufricht Rasp .....	526
Adson Clip Applying Forceps .....	418	Auvarc Vaginal Specula.....	370
Adson Dressing Forceps T.c.....	117	Ayre Knives .....	33
Adson Elevator .....	461	<b>B</b>	
Adson Haemostatic Forceps .....	121, 123	Babcock Intestinal Forceps T.c.....	349
Adson Needle Holders.....	165	Babcock Intestinal Forceps .....	333, 334, 335, 349
Adson Periosteal Elevator .....	463, 465	Babinsky Hammer .....	02
Adson Retractor.....	269, 274, 275	Baby Crile-Wood Needle Holders T.c. ....	179
Adson Suction Tube .....	18	Baby Crile-Wood Needle Holders.....	163
Adson Tissue & Dressing Forceps T.c. ....	116	Baby Metzenbaum Super Cut Scissors.....	82
Adson-Baby Retractor .....	273	Baby-Collin Retractor .....	285
Adson-Brown Tissue & Dressing Forceps .....	106	Baby-Crile Haemostatic Forceps .....	121
Adventitia Scissors .....	75	Baby-Doyen Intestinal Clamps .....	336
Aesculap Forceps .....	559	Baby-Kocher Intestinal Clamps .....	336
Aesculap Sponge & Dressing Forceps .....	155	Baby-Mikulicz Haemostatic Forceps .....	143
Agnew Tympanum Needle.....	497	Baby-Mixer Haemostatic Forceps .....	124
Alar Hooklets, Nasal Retractors .....	515	Baby-Mosquito (Hartmann) Haemostatic Forceps .....	120
Alexander Gouges .....	458	Baby-Overholt Haemostatic Forceps.....	124
Alexander Retractor.....	467	Baby-Roux Retractors .....	231
Alexander Uterine Biopsy Forceps .....	390	Baby-Satinsky De Bakey Vascular Clamps .....	310
Allis Intestinal Forceps T.c .....	349	Baby-Sdson Haemostatic Forceps .....	124
Allis Intestinal Forceps.....	331, 334, 349	Baby-Senn Mueller Retractors .....	214
Allison Retractor .....	255, 321	Backhaus Clip Towel Forceps.....	149
Allport Hooklet .....	203	Backhaus Towel Forceps.....	148
Alligator Ear Forceps & Ear Syringe.....	502	Bacon Bone Rongeurs .....	479
Alm Retractor.....	265	Bailey Rib Spreader.....	320
Amputation & Resection .....	36	Bailey-Gibbon Rib Spreader .....	320
Amputation Knife .....	36	Bainbridge Haemostatic Forceps .....	134
Amputation Saw .....	438	Bainbridge Intestinal Clamps .....	338
Anaestophon Stethoscope .....	03	Bainbridge Vascular Clamps.....	295
Anderson-Adson Retractor .....	274	Bakes Gall Duct Dilator .....	353
Anderson-Neivert Chisel .....	518	Balfour Retractor .....	280
Andrews-Pynchon Suction Tubes.....	20	Balfour-Baby Retractor .....	281
AO Coupling Fiber Handle .....	421	Ball & Socket Towel Forceps .....	149
AO Coupling T-handle .....	421	Ballenger Septum Gouge .....	517
Arruga Needle Holders T.c.....	186	Ballenger Swivel Knife .....	516

DESCRIPTION	PAGE #	DESCRIPTION	PAGE #
Bane Bone Rongeurs .....	481	Billeau Curette .....	499
Barbara Tympanum Needle .....	498	Birch Trocar .....	22
Bardeleben Bone Holding Forceps .....	429	Birkett Haemostatic Forceps .....	135
Barnes-Neville Obstetrical Forceps .....	400	Blade Holder Blade Breaker .....	28
Barnhill Adenoid Curettes .....	551	Blade Retractor .....	469
Barr Rectal .....	347	Blake Gall Stone Forceps .....	356
Barraquer Cilia Forceps .....	113	Blake Suction Curettes .....	377
Barraquer Micro Scissors .....	71	Blalock Clamp .....	320
Barraquer Needle Holders .....	171	Blohmke Tonsil Holding Forceps .....	541
Barraquer Needle Holders .....	171	Blood Scoop Retractor .....	264
Barraquer/with Catch Needle Holders .....	171	Blount Knee Retractor .....	466
Barraquer-Troutman Needle Holders .....	171	Blount Retractors .....	230
Barrett Tenaculum Forceps .....	375	Blumenthal Bone Rongeurs .....	479
Barth Ear Curette .....	498	Boettcher Tonsil Scissors .....	533
Battery Handle .....	06	Böhler Bone Rongeurs .....	483
Baumgartner Needle Holders T.c. ....	174	Boies Septum Forceps .....	530
Baumgartner Needle Holders .....	162	Bone Holding Forceps .....	434
Beacham Tonsil Forceps .....	543	Bone Hook .....	437, 453
Beck De Bakey Vascular Clamps .....	315	Bone Shear .....	327
Beck De Bakey Vascular Clamps .....	316	Bone Tamp Endoscopic .....	447
Beckmann (Negus) Adenoid Curettes .....	551	Bone Tamps .....	453
Beckmann Adenoid Curettes .....	551	Bonney Dissecting Dressing Forceps T.c. ....	118
Beckmann Nasal Speculum .....	510	Bonney Tissue Forceps .....	102
Beckmann-Adson Retractor .....	275	Bose Hook .....	206
Beckmann-Eaton Retractor .....	275	Bose Hooklet .....	555
Bedpan .....	567	Boucheron Ear Specula .....	493
Beebee Wire Cutting Scissors .....	68, 69	Bowl With Lip .....	565
Beer Cilia Forceps .....	113	Bowl .....	565
Bellucci Micro Ear Forceps .....	505	Bowman Lacrimal Probes .....	195
Bending Iron .....	426	Box With Filter .....	562
Bending Template .....	425	Boynton Needle Holders T.c. ....	186
Bengolea Haemostatic Forceps .....	130	Boynton Needle Holders .....	170
Bennett Knee Retractor .....	466	Boys-Allis Intestinal Forceps .....	332
Bensaude Intestinal Rectal .....	348	Bozemann Haemostatic Forceps .....	141
Berger Uterine Biopsy Forceps .....	391	Bozemann Needle Holders T.c. ....	173
Bergmann Bandage Scissors .....	77	Bozemann Needle Holders .....	163
Bergmann Mallet .....	441	Bozemann-Douglas Haemostatic Forceps .....	141
Bergmann Scissors .....	79	Bozemann-Fritsch Uterine Flushing Tube .....	386
Berliner Hammer .....	02	Brand Tendon Forceps .....	473
Bernhard Towel Forceps .....	149	Brantley-Turner Retractor .....	255
Beyer Bone Punch .....	528	Braun Decapitating Hook .....	395
Beyer Bone Rongeurs .....	483	Braun Obstetrical Forceps .....	400
Beyer Mastoid Rongeurs .....	504	Braun Suction Curettes .....	377
Beyer Rongeur .....	482	Braun Tonsil Forceps .....	543, 545
Biemer Suction Tube .....	14	Braun Vaginal Speculum .....	366

# INDEX

DESCRIPTION	PAGE #	DESCRIPTION	PAGE #
Braun-Stadler Bandage Scissors .....	78	Busch Bandage Scissors.....	78
Breisky Obstetrical Measuring Forceps .....	398	Byrd Suction Tube .....	13
Breisky Wiener Modell / Vienna Pattern Retractor .....	369		
Brewster Retractor.....	261	<b>C</b>	
Bridge Haemostatic Forceps .....	134	C - Clamp Drill Guide .....	428
Briesky Vaginal Speculum .....	367	C.W. Mayo Abdominal Retractor .....	261
Bristow's Periosteal Elevators .....	462	Cairns Haemostatic Forceps .....	124
Brodie Probe.....	196	Calipers .....	12
Brom Retractor .....	209	Calipers, Dynamometers, Flexometer .....	11
Broncho-Esophagoscopy Forceps .....	559	Caplan Plaster Shears.....	489
Brophy (Sullivan) Scissors.....	64	Cardinale Operating Scissors T.c. ....	88
Brophy Dressing Forceps .....	98	Cardinale Scissors.....	47
Brophy Tissue Forceps.....	98	Cardiovascular Scissors .....	58
Brown Needle Holders.....	162, 165	Carmalt Splinter Forceps .....	114
Brown Tissue & Dressing Forceps .....	106	Carrel Haemostatic Forceps.....	120
Bruenings Septum Forceps .....	513	Carroll Caliper.....	11
Bruenings Tongue Depressor .....	534	Carroll Needle Holders T.c.....	179
Bruenings Tonsil Snares.....	548	Carroll Needle Holders .....	163
Bruner Retractor .....	237	Carroll Periosteal Elevator .....	465
Brünings Forceps .....	559	Carroll Tendon Forceps .....	473
Brunings Knives .....	33	Caspar Hooklet .....	204
Brunings Septum.....	520	Caspar Laminectomy Rongeur .....	409
Brünings Tonsillectomy Forceps.....	560	Caspar Retractor .....	278
Brunner Intestinal Forceps .....	337	Caspar Retractors .....	227
Brunner Retractor .....	238	Castaneda De Bakey Vascular Clamps.....	311-313
Brunner Rib Sternum Shears .....	328	Castaneda Rib Retractors .....	325
Bruns Bandage Scissors .....	77	Castroviejo Blade Holder .....	28
Bruns Bone Curettes .....	442, 443, 445	Castroviejo Caliper .....	12
Bruns Plaster Scissors T.c.....	92	Castroviejo Micro Scissors .....	71, 72
Bryant Sponge & Dressing Forceps .....	152	Castroviejo Needle Holders T.c .....	185, 187
Buchwald Tongue Depressor .....	534	Castroviejo Needle Holders.....	171
Buck Applicator.....	199	Castroviejo Olsen Heager / Needle Holders / Scissors .....	170
Buck Ear Curette .....	498	Castroviejo-Epker Caliper.....	12
Buck Ear Polypus Forceps .....	501	Cather Tray.....	562
Buck Hammer.....	01	Catheter Dilator .....	354
Buck Stitch Scissors .....	67	Catlin Knife .....	36
Buck Tympanum Needle.....	497	Catlin Knives.....	34
Bucket with lid.....	566	Chadwick Scissors .....	66
Buckley Retractor .....	265	Chandler Bone Elevator .....	461
Buelau Trocar .....	21	Chaput Haemostatic Forceps .....	154
Bulldog Clamp .....	291	Chaput Intestinal Forceps.....	332
Burford Rib Retractors .....	326	Charnley Bone Forceps .....	430
Burke Uterine Biopsy Forceps.....	389	Charnley Tissue & Dressing Forceps .....	101
Burnham Bandage Scissors .....	79		



DESCRIPTION	PAGE #	DESCRIPTION	PAGE #
Charnley-Mueller Compression Clamp.....	478	Collin Rib Shears.....	329
Charriere Saw .....	36	Collin Scalpel Handle .....	25
Charriere Saw.....	81, 438	Collin Sponge & Dressing Forceps.....	156, 161
Cheatel Box Joint Sterilizing Forceps.....	569	Collin Suction Curettes .....	378
Cheatel Screw Joint Sterilizing Forceps.....	569	Collin Suture Forceps .....	200
Cheek Retractors & Tongue Depressors .....	540	Collin Vaginal Speculum.....	362
Cheek & Lip Retractor Movable.....	244	Collin-Duval Tissue Forceps.....	103
Cheron Sponge & Dressing Forceps.....	156	Collin-Hartmann Retractors .....	214
Chevalier-Jackson Tracheal Tube .....	553	Colver Tonsil Forceps .....	542
Childe Suture Forceps.....	200	Combination Wrench .....	425
Chisel Handle .....	456	Compression Device .....	425
Chisels / Osteotomes .....	448	Cone Clip Applying Forceps .....	418
Christophe Haemostatic Forceps .....	122	Cone Retractor .....	268
Church Vascular Scissors.....	61	Conventional Laryngoscope Set.....	08
Cilia Forceps.....	113	Converse Alar Hooklet.....	515
Cinelli Osteotome .....	519	Converse Chisel .....	518
Citelli Laminectomy Rongeur.....	410	Converse Needle Holders T.c.....	178
Citelli Mastoid Rongeurs .....	504	Cooley Bakey Vascular Clamps.....	317
Classon Scissors .....	56	Cooley De Bakey Vascular Clamps.....	316
Cleveland Bone Cutting Forceps.....	487	Cooley Arteriotomy Scissors.....	56
Cleveland Bone Rongeur .....	480	Cooley Atraumatic Dressing Forceps .....	108
Cleveland-Gardner Bone Cutting Forceps .....	486	Cooley Cardiovascular Scissors.....	57
Cloward Modif. Retractor.....	277	Cooley Clamping Forceps .....	314
Cloward Retractor.....	288	Cooley De Bakey Vascular Clamps.....	301, 311
Cloward Spreader.....	419	Cooley Intracardiac Needle Holders T.c.....	177
Cloward-Type Laminectomy Rongeurs .....	404	Cooley Microvascular Needle Holders T.c.....	183
Cloward-Type Rongeur.....	405	Cooley Retractor.....	257
Clutton Bougies .....	354	Cooley Reverse Cut Scissors.....	52
Coakley Sinus Curettes .....	550	Cooley Rib Retractor .....	322
Coakley Trocar .....	22	Cooley Suction Tube .....	13
Cobb Chisel / Osteotomes .....	448	Cooley Vascular Forceps.....	321
Cobb Elevators .....	461	Cooley Vascular Scissors .....	54
Cobb Gouges .....	454	Cooley-Baumgaften Wire Twister T.c.....	180
Cobb Modif. Elevator .....	460	Cooley-Derra De Bakey Vascular Clamps.....	318
Cobb Spinal Elevator .....	460	Cooper Needle .....	192
Cobb Spinal Elevator Endoscopic.....	449	Cope Hooklets .....	213
Coller Haemostatic Forceps .....	122	Cordes Tonsillectomy Forceps.....	560
Collier Needle Holders.....	167	Corwin Needle Holders T.c.....	188
Collin Bone Holding Forceps .....	429	Corwin Round Scalpel Handle .....	28
Collin Intestinal Forceps .....	333	Coryllos Retractors .....	236
Collin Intestinal Forceps .....	334	Cottle Alar Hooklet.....	515
Collin Kidney Stone Forceps .....	351	Cottle Cartilage Crusher .....	530
Collin Knives .....	30, 34	Cottle Elevator.....	522
Collin Obstetrical Measuring Forceps.....	398	Cottle Hook.....	207
Collin Retractor.....	232, 282, 284, 285	Cottle Hooklet.....	203

# INDEX

DESCRIPTION	PAGE #	DESCRIPTION	PAGE #
Cottle Mallet.....	441	Cushing-Kocher Hooklet.....	218
Cottle Nasal Scissors .....	63	Cuticle Nipper .....	201
Cottle Nasal Speculum .....	508	Czerny Rectal .....	347
Cottle Nasal Speculum .....	509	Czerny Tonsil Forceps .....	545
Cottle Periosteal Elevator .....	522		
Cottle Retractor .....	215, 515	<b>D</b>	
Cottle Scissors T.c. ....	94	Dale Vascular Clamps .....	293
Cottle Septal Speculum .....	511	Dandy Haemostatic Forceps .....	121
Cottle-Kazanjian Bone Cutting Forceps .....	488	Dandy Vascular Scissors .....	59
Cottle-Neivert Alar Hooklet .....	515	Darling Retractor .....	268
Cottle-Neivert Hook .....	207	Dartigues Kidney Stone Forceps .....	351
Cotton Holder .....	566	Dartigues Seizing Forceps .....	376
Coupland Suction Tube .....	13	Davidson Retractors .....	236
Coupling Dental Handle .....	421	Davis Dura Dissectors .....	470
Crafoord Haemostatic Forceps.....	130, 137	Davis Nerve Separator & Spatula.....	416
Crafoord Lobectomy Scissors .....	57	Davis Sterilizing Forceps .....	569
Crafoord Scissors .....	62	Davis Tissue Forceps .....	103
Crafoord-Sellors Haemostatic Forceps .....	135	Davis-Boyle Mouth Gage.....	537
Crawford Retractor .....	263	Day Hooklet .....	205
Crile Haemostatic Forceps .....	121	De Bakey - Bahnson Vascular Clamps.....	299
Crile Hooklet .....	205	De Bakey - Mosquito Vascular Clamps .....	295
Crile Needle Holders .....	170	De Bakey - Rankin Vascular Clamps.....	295
Crile Retractors.....	230	De Bakey / Lightweight Tissue Forceps .....	107
Crile-Murray Needle Holders .....	168	De Bakey / Pediatric Vascular Clamps .....	319
Crile-Wood Needle Holders T.c .....	181, 172, 174	De Bakey Clamping Forceps .....	289
Crile-Wood Needle Holders .....	163, 176	De Bakey Femur Retractor.....	276
Crura-Nipper Micro Ear Forceps .....	506	De Bakey Needle Holders T.c.....	172
Crutchfield Skull Traction Tong Cups.....	403	De Bakey Tissue & Dressing Forceps .....	107
Curette .....	471	De Bakey Vascular Clamps .....	296, 300, 302-309
Cusco Vaginal Speculum.....	361, 362	De Bakey Vascular Scissors.....	54, 60
Cushing Bone Drills .....	423	De Lee Corner Retractors .....	262
Cushing Decompression Retractor .....	468	De Lee Obstetrical Forceps .....	400
Cushing Dressing Forceps T.c. ....	117	De Lee Obstetrical Measuring Forceps .....	398
Cushing Dressing Forceps.....	97, 119	De Lee Universal Retractors .....	262
Cushing Hand Drills .....	402	De Martel-Wolfson Anastomosis Clamps .....	342
Cushing Hook .....	207	De Vilbiss Vaginal Speculum .....	361
Cushing Hooklet .....	218	Dean Scissors T.c.....	92
Cushing Laminectomy Rongeurs .....	404	Dean Tonsil Scissors .....	533
Cushing Love Gruenwald Spurling Rongeur .....	405	Dean-Dellicate Scissors .....	51
Cushing Periosteal Elevators .....	463,465	Dean-Shellcross Haemostatic Forceps .....	135
Cushing Pituitary Spoon.....	446	Deaver Operating Scissors.....	40
Cushing Tissue Forceps T.c.....	117	Deaver Retractor .....	241, 242, 246-247
Cushing Tissue Forceps .....	98, 119	Debakey Atraumatic Dressing Forceps .....	108
Cushing Vein Retractor .....	468	Debakey Bulldog Clamps .....	290

DESCRIPTION	PAGE #	DESCRIPTION	PAGE #
Debakey Cardiovascular Needle		Dissector.....	471
Holders T.c.....	177	Dittel Urethral Catheters .....	355
Debakey Endarterectomy Scissors .....	58	Dixon-Lovelace Haemostatic Forceps.....	136
Debakey Micro Needle Pulling Tissue		Douay Uterine Biopsy Forceps.....	392
Forceps T.c.....	118	Double Prong Micro Hook .....	202
Debakey Scissors T.c. ....	93	Douglas Cilia Forceps.....	113
De-Bakey Suction Tube .....	17	Douglas Trocar .....	21
Debakey Vascular Scissors .....	55	Doyen Intestinal Clamps.....	336, 339
Debakey-Diethrich Bulldog Calmps.....	292	Doyen Lateral Speculum .....	369
Debakey-Potts Scissors .....	55	Doyen Mallets.....	440
Debakey-Vascular/Extra Light Needle		Doyen Myoma Screw .....	376
Holders T.c.....	179	Doyen Needle Holders .....	167
Decker Intervertebral Disc Laminectomy		Doyen Operating Scissors.....	46
Rongeur .....	414	Doyen Probe.....	196
Dejerine Hammer .....	01	Doyen Retractor .....	244, 284
Demartel Vascular Scissors.....	58	Doyen Rib Raspatory .....	461
Denhardt Mouth Gag .....	535	Doyen Rib Shears .....	329
Denis-Browne Retractor .....	286	Doyen Towel Forceps .....	148
Depth Gauge .....	425	Doyen Vaginal Retractors.....	252
Derf Needle Holders T.c.....	178,181	Doyen Vaginal Specula (for Children	
Derf Needle Holders .....	167	& Virgins) .....	368
Deschamps Needle .....	192-194	Doyen Vaginal Speculum.....	367
Desjardins Gall Duct Dilator .....	353	Doyen-Collin Mouth Gag .....	535
Desjardins Gall Stone Forceps .....	357	Doyen-Stille Retractors.....	239
Desjardins Haemostatic Forceps.....	137	Dressing Forceps T.c. ....	119
Desmarres Hooklet .....	218	Dressing Jar With Knob.....	565
Devibiss Clip Applying Forceps .....	418	Dressing Jar .....	565
Diagnostic Set .....	05	Drill Bits .....	420
Diagnostic Sets With Standard Illumination.....	05	Drill Guide .....	428
Diamant Pin Cutter .....	490	Drill Pointed Guide .....	428
Dick Haemostatic Forceps.....	146	Drill Sleeve .....	425, 427
Dieffenbach Knives.....	29, 30,34	Drill Small Pointed .....	428
Diethrich/Micro Coronary Clamp .....	291	Dubois Scissors.....	47
Dietrich Vascular Clamps.....	293	Duckbill Alligator Ear Forceps.....	502
Dingmann Bone Holding Forceps.....	429	Duehrssen Dressing Forceps .....	103
Dingmann Mouth Gage .....	539	Duehrssen Tissue Forceps .....	103
Director .....	196	Duke Trocar.....	22
Dissecting & Gynecological Scissors .....	41, 47	Dunhill Haemostatic Forceps.....	123
Dissecting Ket.....	10	Duplay Sponge & Dressing Forceps .....	153
Dissecting Knives .....	29-33, 34, 35	Duplay Sponge Forceps .....	159
Dissecting Scissors .....	51	Duplay Tonsil Forceps .....	543
Dissecting Scissors T.c. ....	89, 90	Duplex Stethoscope .....	03
Dissecting Scissors .....	43, 50, 62	Duplex-Baby Stethoscope .....	03
Dissecting Sets.....	06	Dura Twist Hook .....	416
Dissecting Tissue Forceps T.c. ....	117	Durante Tissue Forceps .....	102
Dissection Scissors .....	75		

# INDEX

DESCRIPTION	PAGE #	DESCRIPTION	PAGE #
Dust Bin .....	567	.....	431
Duval Intestinal Forceps .....	332	Farrell Applicator .....	198, 199
Duval Intestinal Forceps .....	335	Faulkner Ehtmoid Currettes .....	550
Duval Intestinal Forceps .....	349	Faure Biopsy Forceps .....	394
Duval-Collin Intestinal Forceps .....	332	Favaloro Coronary Scissors .....	56
<b>E</b>		Favaloro Vascular Scissors .....	59
Ear Forceps .....	507	Fehland Intestinal Forceps .....	337
Ear Hooklets & Tympanum Needle .....	500	Feilchenfeld Splinter Forceps .....	114
Ear Hooklets, Tympanum Needle .....	499	Ferguson Bone Holding Forceps .....	429
Ear Polypus Forceps .....	501	Ferguson-Ackland Mouth Gag .....	535
Ear Specula .....	493	Ferguson-Moon Rectal Retractors .....	258
Ear Speculum .....	494	Fergusson Operating Scissors .....	40
Echlin / Stille-Luer Bone Rongeur .....	482	Fergusson Suction Tube .....	19, 531
Echlin Bone Rongeur .....	484	Fergusson Tubing Clump .....	150
Eicken Tonsillectomy Forceps .....	560	Ferris - Smith Laminectomy Rongeur .....	413
Eiselsberg Scissors .....	66	Ferris-Smith Tissue Forceps .....	102
Eiselsberg-Matheiu Needle Holders T.c.....	189	Fiber Key Handle .....	421
Electric Mirror .....	552	Fiberoptic & Disposable Laryngoscope Set.....	09
Emmet Hook .....	206	Fiberoptic Laryngoscope Set .....	08
Emmet Sponge & Dressing Forceps .....	156	Finocchietto (Modif.) Retractor .....	323
Endoscope Basket .....	568	Finocchietto / Baby Rib Retractors .....	325
Enema Cane .....	567	Finocchietto Infant Rib Retractor .....	322
Engel Plaster Saw .....	81, 438	Finocchietto Needle Holders .....	164
Engl. Modell Towel Forceps .....	148	Finocchietto Rib Retractors .....	325
Ent-Dean Vascular Scissors .....	57	Finochietto Haemostatic Forceps .....	132
Enterotomy Scissors .....	62	Finochietto Needle Holders T.c.....	175
Eppendorf Uterine Biopsy Forceps .....	391, 392	Finochietto Vascular Scissors .....	57
Esmarch Knife .....	77	Finsen Retractor .....	265
Esmarch Scissors .....	77	Finsterer Suction Tubes .....	24
Eufrate Pasque Needle Holders T.c.....	179	Fisch Ear Hooklet .....	500
Evans Dressing Forceps .....	119	Fisch Hooklet .....	202
Evans Pelvic Needle Tissue Forceps .....	119	Flat Gouge .....	455
Eves Tonsil Snares .....	548	Flat Nose Pliers .....	473
Ewald / Hudson Tissue & Dressing Forceps ....	106	Flat Nose Parallel Pliers .....	474
Extraction Pliers .....	475, 476, 491	Flat-Nose Pliers .....	475
<b>F</b>		Fletcher Sponge Forceps .....	158
Face-Life, Dissecting, Nasal Scissors .....	44	Fleurant Trocar .....	21
Farabeuf Periosteal Elevators .....	464	Foerster Sponge Forceps .....	160
Farabeuf Retractors .....	232	Foerster-Ballenger Sponge Forceps .....	159
Farabeuf-Lambotte Bone Holding Forceps .....		Foerster-Ballenger Sponge Forceps .....	160
		Foman Rasp .....	453
		Fomon Alar Hooklet .....	515
		Fomon Hook .....	207
		Fomon Nasal Scissors .....	63
		Fomon Osteotome .....	519

DESCRIPTION	PAGE #	DESCRIPTION	PAGE #
Fomon Rasp .....	527	Gelpi Vaginal Retractor .....	276
Fomon Scissors T.c. ....	94	Gelpi-Ioktite Retractor .....	268
Fomon Scissors .....	44	Gemini Haemostatic Forceps .....	133
Forceps Jar .....	566	General Instruments .....	195-199, 201
Foregger Laryngoscope .....	07	Gerald Dressing Forceps .....	97, 98
Fowler Knives .....	33	Gerald Tissue Forceps .....	98
Fraenkel Tonsillectomy Forceps .....	560	Gerster Bone Clamp .....	432
Frazier 30° Suction Tube .....	18	Gerzog Mallet .....	441
Frazier 45° Suction Tube .....	18	Gerzog-Sexton Tympanum Needle .....	497
Frazier Dura Dissectors .....	470	Giertz-semb Rib Sternum Shears .....	328
Frazier Hooklet .....	202	Gigli Handle .....	438
Frazier Nerve Hooks .....	416	Gigli Saw .....	438
Frazier Suction Tube .....	18-20, 531	Gillies Hooklet .....	202
Frazier-Ferguson Suction Tube .....	18	Gillies Needle Holders .....	166, 176
Freer Alar Hooklet .....	515	Gillies Nerve Hooks .....	416
Freer Elevator .....	324, 452, 520, 523	Gillies Osteotome .....	518
Freer Hooklet .....	202	Gillies Tissue Forceps .....	99
Freer Knife .....	324	Gil-Vernet Hooklet .....	217
Freer Mucous Knife .....	520	Gil-Vernet Retractors .....	235
Freer Raspatory .....	520, 522, 520	Glabella Rasps & Nasal Rasps .....	527
Freer Separator & Elevator .....	521	Glabella Rasps, Nasal Rasps .....	526
Freer Septum Chisel .....	517, 522	Glover De Bakey Vascular Clamps .....	302, 311
Freer Septum Gouge .....	517	Glover Vascular Clamps .....	305
Freer Yasargil Dissector .....	520, 523	Gluck Rib Shear .....	327
French-Eye Needle Holders T.c. ....	174	Goelet Retractor .....	251
Frenzel Tongue Depressor .....	534	Goldman-Fox (spezial) Scissors .....	51
Fricke Artery Forceps .....	151	Goldman-Fox Operating Scissors T.c. ....	88
Friedman & Mini-Friedman Bone Rongeurs .....	479	Goldman-Fox Scissors .....	51
Friedmann Retractor .....	373	Goldman-Fox Super Cut Scissors .....	82
Fritch Retractor .....	244	Good Scissors .....	64
Fulton Scissors .....	53	Good Tonsil Scissors .....	533
Furnal .....	567	Gorney Scissors T.c. ....	91
		Gorney Septal Scissors .....	489
		Gorney Suction Tube .....	19
		Gosset Retractor .....	279, 281
		Gourdet Uterine Depressor .....	378
		Gradle Cilia Forceps .....	113
		Graduated Metal Ruler .....	11
		Graduated Tape Measurer .....	11
		Graefe Dressing Forceps T.c. ....	111
		Graefe Hook .....	207
		Graefe Hooklet .....	205
		Graefe Tissue & Dressing Forceps T.c. ....	111
		Graefe Tissue Forceps T.c. ....	111
		Graig Septum Forceps .....	513

## G

G Loves Box .....	562
Galabin Uterine Sounds .....	384
Galipots .....	566
Gall Stone Forceps .....	357
Galt Bone Drill .....	402
Garland Haemostatic Forceps .....	136
Gauss Obstetrical Forceps .....	397
Gayne Evans Tonsil Dissector .....	546
Gellhorn Biopsy Forceps .....	394
Gelpi Skin & Vaginal Retractor .....	276

# INDEX

DESCRIPTION	PAGE #	DESCRIPTION	PAGE #
Graig-Domnick Septum Forceps .....	513	Hard Tonsil Dissector .....	547
Graves Vaginal Speculum Leep / Lietz .....	360	Harrington Retractors .....	245
Graves Vaginal Speculum .....	360	Harrington Spinal Elevator .....	449, 460
Gray Haemostatic Forceps .....	137, 142	Harris Angled Suture Forceps .....	358
Grazil Dissecting Scissors .....	39	Hartmann / French Tuning Forks .....	495
Grazil Operating Scissors .....	39	Hartmann Alligator Ear Forceps .....	502
Green Retractors .....	228	Hartmann Bone Rongeurs .....	479
Green-Armytage Obstetrical Forceps .....	397	Hartmann Ear Hooklet .....	500
Green-Armytage Placenta Forceps .....	396	Hartmann Ear Specula .....	493
Gregory Vascular Clamps .....	294	Hartmann Eustachian Catheters .....	494
Gregory-Soft Clamping Forceps .....	289	Hartmann Hook .....	206
Grey Turner Haemostatic Forceps .....	123	Hartmann Nasal Cutting Forceps .....	529
Groenholm Retractor .....	209	Hartmann Nasal Speculum .....	510
Gross Ear Hooklet .....	500	Hartmann Septum Forceps .....	512
Gross Sponge & Dressing Forceps .....	153	Hartmann Tongue Depressor .....	540
Gruber Aural Specula .....	493	Hartmann Tuning Forks .....	495
Gruenwald-Henke Nasal Cutting Forceps .....	529	Hartmann Tuning Forks .....	496
Guedel-Negus / Miller Laryngoscope .....	07	Hartmann-French Tuning Forks .....	496
Guedel-Negus Laryngoscope .....	06	Hartmann-Halle Nasal Speculum .....	510
Gum Locklin Scissors T.c. ....	92	Hartmann-Hoffmann Alligator Ear Forceps .....	502
Gum, Operating Scissors .....	64	Hartmann-Noyes Alligator Ear Forceps .....	502
Gum, Stitch Scissors .....	66	Harvey Scissors .....	66
Gumco Clamp .....	359	Harvey Wire Cutting Scissors .....	69
Guthrie Hooklet .....	202	Haslinger Tonsil Snares .....	549
Guyon Dilating Bougies .....	354	Heaney / Ballantine Haemostatic Forceps .....	136
Guyon Haemostatic Forceps .....	138	Heaney / Rezak Haemostatic Forceps .....	136
Guyon Urethral Catheters .....	355	Heaney Haemostatic Forceps .....	139, 144, 145
		Heaney Modif. Haemostatic Forceps .....	144
		Heaney Needle Holders .....	165, 176
		Heaney-Gyne Needle Holders T.c .....	182
		Heaney-Kanter Haemostatic Forceps .....	139
		Heany Retractor .....	262
		Heath Vascular Scissors .....	54
		Hegar Gyne Uterine Dilators .....	388
		Hegar Uterine Dilators .....	387
		Hegar-Baumgartner Needle Holders .....	168
		Hegemann-Diethrich Scissors .....	52
		Hegenbarth Suture Forceps .....	200
		Heiss Haemostatic Forceps .....	130, 132, 140
		Heiss Retractor .....	265
		Heister Mouth Gag .....	536
		Hening Spreader .....	81
		Henke Tonsil Dissector .....	546
		Henley Retractor .....	267
		Hennig Plaster Shears .....	489

## H

Haberer Intestinal Clamp Forceps .....	345
Haig Ferguson Obstetrical Forceps .....	400
Haight Rib Retractor .....	323
Hajek Mallet .....	441
Hajek-Kofler Laminectomy Rongeur .....	410
Hakansson Bone Rongeurs .....	481
Halle Elevator .....	520, 522
Halle Nasal Speculum .....	511
Halle Scissors .....	64
Halsey Needle Holders T.c. ....	178
Halsey Needle Holders .....	167, 176
Halsted Haemostatic Forceps .....	122, 130
Halsted-Mosquito Haemostatic Forceps .....	120, 130
Hank Gyne Uterine Dilators .....	387
Hank Uterine Dilators .....	387



# INDEX

DESCRIPTION	PAGE #	DESCRIPTION	PAGE #
<b>J</b>		<b>Jurasz Laryngeal Polypus Forceps</b> .....558	
Jackson Burrows Retractor .....	276	<b>K</b>	
Jackson Retractor.....	555	Kader Retractor .....	248, 263
Jackson Tendon Seizing Forceps .....	157	Kahler Tonsillectomy Forceps.....	560
Jackson Vaginal Specula .....	365	Kallmorgen Vaginal Retractor .....	367
Jacob's Chuck .....	421	Kallmorgen Vaginal Speculum.....	367
Jacobs Tenaculum Forceps .....	376	Kalt Needle Holders T.c.....	187
Jacobs Tonsil Forceps .....	545	Kalt Needle Holders.....	171
Jacobson Haemostatic Forceps .....	122	Kantrowitz Haemostatic Forceps .....	134
Jacobson Heavy Style Needle Holders T.c.....	187	Kay De Bakey Vascular Clamps .....	303
Jacobson Needle Holders T.c... 185, 186, 173, 187		Kaye Face-Lift Scissors .....	44
Jacobson Needle Holders .....	164	Kaye Scalpel Handle .....	28
Jager Tendon & Cross Ligament Passing Forceps .....	157	Kaye-Millard Retractor.....	251
Jameson Caliper .....	11	Kelly Haemostatic Forceps .....	120
Jameson Needle Holders .....	164	Kelly Intestinal Rectal .....	348
Jamison Super Cut Scissors .....	84	Kelly Operating Scissors .....	46
Janden Ear Curette .....	498	Kelly Retractor .....	243, 258, 260, 261
Jansen Bone Curettes Double-ended .....	444	Kelly Scissors T.c.....	91
Jansen Ear Forceps .....	507	Kelly Sponge & Dressing Forceps.....	161
Jansen Retractor .....	265	Kern Bone Holding Forceps .....	431
Jansen-Gruenwald Dressing Forceps .....	104	Kerrison Bone Punche.....	528
Jansen-Middleton Septum Forceps.....	525	Kerrison Puncher .....	412
Jatho Biopsy Forceps .....	558	Kevorkian Suction Curettes .....	377
Jatho Nasopharynx Forceps.....	558	Kevorkian Uterine Biopsy Forceps .....	392, 393
Javid Vascular Clamps .....	319	Kevorkian-Pacific Uterine Biopsy Forceps .....	390
Jean Tissue & Dressing Forceps.....	101	Key Handle .....	421
Jeweler Type, Dissecting Forceps .....	112	Key Periosteal Elevator .....	461, 463,465
John Hopkins Haemostatic Forceps .....	140	Key Dermal Punch.....	532
John-Hopkins Bulldog Holding Forceps .....	292	Key Modif. Dermal Punch.....	532
Johns-Hopkins (Potts Modif.) Clamp .....	320	Kidney Tray (German Pattern).....	565
Johnson Needle Holders .....	168	Kidney Tray With Cover (English Pattern) .....	565
Johnson Prostatic Needle Holder .....	358	Kielland Obstetrical Forceps.....	399
Joll (Friedman) Thyroid- & Veginal Retractor....	276	Kielland-Luikart Obstetrical Forceps.....	400
Jones / Perforating Towel Forceps .....	148	Killian Applicator .....	198
Jorgenson Operating Scissors .....	40	Killian Elevator .....	521, 523
Joseph Alar Hooklet.....	515	Killian Nasal Speculum .....	508, 511
Joseph Hooklet.....	203	Killian Septum Forceps .....	512, 525
Joseph Nasal Saws .....	516	Killian Septum Gouge .....	517
Joseph Operating Scissors.....	45	Killian-Claus Septum Gouge .....	517
Joseph Rasp.....	527	Killner Scissors .....	48
Joseph Scissors T.c.....	92	Kilner Alar Hooklet.....	515
Judd-Allis Intestinal Forceps.....	331	Kilner Hook .....	206
Julian Needle Holders T.c .....	183	Kilner Hooklet .....	202



DESCRIPTION	PAGE #	DESCRIPTION	PAGE #
Kilner Needle Holders T.c.....	173	Kuehne Cilia Forceps.....	113
Kilner Needle Holders.....	167	Kuemmel Retractor.....	249, 256
Kilner Operating Scissors.....	45		
Kilner-Doughty Mouth Gage.....	539	<b>L</b>	
Kirschner Retractor.....	287	La Forceps Adenotomes.....	551
Kirschner.....	478	Laborde Tongue Holding Forceps.....	554
Kirschner-Balfour Retractor.....	287	Lahey (Sweet) Haemostatic Forceps.....	137
Kirstein Nasal Scissors.....	514	Lahey Clinic Nerve Hooks.....	416
Klapp Retractors.....	229	Lahey Goiter Retractor.....	227
Kleinert Kutz Elevator & Dissector.....	452	Lahey Retractors.....	227
Kleinert-Kutz Bone Rongeurs.....	483	Lahey Tonsil Forceps.....	542
Klinikum Berlin Tubing Clump.....	150	Lambert-Kay Vascular Clamps.....	304
Klinkenbergh-Loth Vascular Scissors.....	61	Lambotte Bone Holding Forceps.....	431
Knapp Iris Scissors.....	49	Lambotte Hooklets.....	212
Knee Retractor.....	224	Lambotte Osteotome.....	457, 459, 519
Knight Nasal Scissors.....	63	Lambotte Periosteal Elevators.....	464
Knight Septum Forceps.....	513	Landau Retractor.....	369
Knighthon Retractor.....	266	Landau Trocar.....	22
Knowles Scissors.....	79	Landolt Laminectomy Rongeur.....	407
Knutson Urethrographie-Instrument.....	359	Landolt Operating Scissors.....	65
Kocher Haemostatic Forceps.....	128	Landolt Scissors.....	66
Kocher Hooklets.....	211	Landolt Suction Tube.....	23
Kocher Intestinal Clamps.....	336, 338	Landolt Suction Tubes.....	24
Kocher Retractor.....	219, 220, 222, 253	Landon Vaginal Retractor.....	367
Kocher Tonsil Dissector.....	547	Lane Bone Holding Forceps.....	431
Kocher-Langenbeck Retractors.....	221	Lane Intestinal Clamp Forceps.....	344
Kocher-Ochsner Haemostatic Forceps.....	127	Lane Intestinal Forceps.....	335
Kocher-Wagner Retractor.....	222	Lane Periosteal Elevators.....	462
Koenig Tuning Forks.....	496	Lane Tissue Forceps.....	102
Koerte Retractor.....	233, 256	Lange Alar Hooklet.....	515
Kogan Endo Cervical Speculum.....	374	Lange Hook.....	206
Kogan Gyne Endo Cervical Speculum.....	374	Lange Suture Forceps.....	200
Koenig Retractors.....	215	Lange Tonsillectomy Forceps.....	560
Korte-Wagner Retractors.....	233	Lange-Hohmann Retractor.....	467
Krause Nasal Polypus Snare.....	514	Langenbeck Ear Curette.....	498
Krause Tonsillectomy Forceps.....	560	Langenbeck Knife.....	34, 36
Krause Trocar.....	22	Langenbeck Needle Holders T.c.....	189
Krause-Voss Nasal Polypus Snare.....	514	Langenbeck Periosteal Elevators.....	463-465
Krayenbuhl Hooklet.....	204	Langenbeck Retractor.....	223-225
Kristeller Vaginal Specula.....	365	Langenbeck-Delicate Needle Holders T.c.....	189
Kristeller Vaginal Specula (Upper & Lower Blades).....	364	Langenbeck-Mini Retractor.....	213
Kristeller Vaginal Speculum.....	363	Langenbeck-Ryder Needle Holders T.c.....	189
Kronecker Needle.....	192	Large Countersink.....	420
Kronlenin Haemostatic Forceps.....	151	Laryngeal Mirror.....	552

# INDEX

DESCRIPTION	PAGE #	DESCRIPTION	PAGE #
Laryngeal Mirror Handle .....	552	Forceps .....	152
Laryngoscope & Accessories .....	07	Lister-Excentric Bandage Scissors .....	79
Laryngoscope Conventional & Fiberoptic Set(Double Set) .....	08	Liston Bone Cutting Forceps .....	486, 487
Laryngoscope Holder .....	557	Liston Knives .....	34
Lateral Vaginal Retractor Blue Coated Leep / Lietz .....	372	Liston-Key (Horsley) Bone Cutting Forceps .....	488
Lateral Vaginal Retractor .....	372	Liston-Stille Bone Cutting Forceps .....	487
Lathbury-Farrel Applicator .....	198, 199	Littauer / Liston Bone Cutting Forceps .....	486
Lawrence Haemostatic Forceps .....	134	Littauer Cilia Forceps .....	113
Le Grange Scissors .....	66	Littauer Stitch Scissors .....	67
Lead Hand .....	473	Little Retractor .....	229, 469
Lebsche Sternum Chisel .....	327	Little Wood Tissue Forceps .....	335
Leedham Tissue & Dressing Forceps .....	101	Littler Scissors .....	48
Lees Vascular Clamps .....	304	Litwak General Utility Scissors .....	58
Legueu Retractor .....	253, 284	Litwin Angled Scissors .....	55
Leksell Bone Rongeur .....	484	Lockhart-Mummery Probe .....	196
Leksell Rongeur Forceps .....	485	Locking Pliers .....	474
Leksell-Stille Bone Rongeur .....	482	Locklin Scissors .....	51
Leland-Jones De Bakey Vascular Clamps .....	306	Lockwood Intestinal Forceps .....	333
Lempert Bone Rongeurs .....	481	Long Haemostatic Forceps .....	142
Lempert Ear Curette .....	498	Lopez-Reinke Suction Tube .....	19
Lerche Tissue Forceps .....	99	Lorenz Scissors .....	79
Leriche Retractor .....	249	Lorer-Reinke Tonsil Suction Dissector .....	547
Lewin Bone Clamp .....	432	Lorna Towel Forceps .....	149
Lewis Rasp .....	526	Loute Vise Grip Pliers .....	474
Lexer Gouge .....	455	Love Gruenwald Laminectomy Rongeur .....	409
Lexer Modif. Gouge .....	455	Love Retractor .....	216
Lexer Modif. Osteotome .....	455	Love Tonsil Snares .....	549
Lexer Operating Scissors T.c .....	87	Love-Gruenwald Laminectomy Rongeurs .....	404
Lexer Osteotome .....	455	Love-Kerrison Laminectomy Punch .....	411
Lexer Scissors .....	44	Lower Haemostatic Forceps .....	137
Lexer-Baby Scissors .....	44	Lowman-Hoglund Bone Clamp .....	432
Leyla Self-Retaining Brain Retractor .....	401	Lowmann Bone Clamp .....	432
Lichtenberg Needle Holders T.c .....	188	Lubet-Barbon Septum Forceps .....	512
Lichtenberg Needle Holders .....	170	Luc Septum Forceps .....	513
Lichtwitz Antrum Trocar .....	20	Lucae / Ent Dressing Forceps .....	104
Lichtwitz Trocar .....	22	Lucae Ear Forceps .....	507
Ligature Needles .....	192-194	Lucae Ear Hooklet .....	500
Lightweight-Adson Tissue Forceps .....	107	Lucae Hooklet .....	205
Lincole Vascular Scissors .....	61	Lucae Mallets .....	440
Lister Bandage Plaster Scissors T.c .....	92	Lucae Tuning Forks .....	495, 496
Lister Bandage Scissors .....	77, 79	Lucae Tympanum Needle .....	497
Lister Bougies Catheter .....	354	Lucas Bone Curettes Double-ended .....	443
Lister Sinus Forceps Sponge & Dressing		Luer Bone Rongeur .....	479, 480
		Luer Retractor .....	555
		Luer Retractors .....	230

DESCRIPTION	PAGE #	DESCRIPTION	PAGE #
Luer Suction Tubes .....	20	Masson-Luethy Needle Holders .....	166
Luer Tracheal Tubes .....	553	Masson-Lutti-Bozeman Needle Holders T.c .....	184
Luethy-Beck Needle Holders T.c .....	189	Mathieu Needle Holders .....	169
Lukens Hooklets .....	213	Mathieu Rectal .....	347
Lukens Retractor .....	555	Mathieu Retractors .....	230
Lumbar Lamina Spreader .....	419	Mathieu Vaginal Retractor .....	367
Lumbar, Cervical Impactors & Drivers .....	447	Mathieu Vaginal Speculum .....	366
Luniatscheck Tonsil Dissector .....	546	Mathieu-Ryder Needle Holders T.c.....	188
		Mathieu-Ryder Vascular Needle Holders T.c ...	188
		Mathieu-Stille Needle Holders T.c.....	186
		Matin Tonsil Snares .....	549
		Matson Retractor .....	467
		Maurer-Collin Cutting Forceps .....	328
		Mayfield Bone Rongeur .....	482, 484
		Mayo Abdominal Retractor .....	261
		Mayo Dissecting Scissors .....	41
		Mayo Operating Scissors T.c.....	86
		Mayo Rochester Needle Holders.....	169
		Mayo Super Cut Scissors .....	84
		Mayo Uterine Sounds .....	383
		Mayo-Adams Retractor.....	269
		Mayo-Adams Retractor.....	273
		Mayo-Blake Gall Stone Forceps .....	356
		Mayo-Collin Retractors .....	232
		Mayo-Harrington Dissecting Scissors.....	58
		Mayo-Hegar Needle Holders T.c.....	175
		Mayo-Hegar Needle Holders .....	162
		Mayo-Noble Dissecting Scissors .....	41
		Mayo-Robson Intestinal Clamps.....	336
		Mayo-Russian Tissue Forceps .....	103
		Mayo-Stille Dissecting Scissors .....	41
		Mayo-Stille Operating Scissors T.c.....	87
		Mc Indoe Bone Cutting Forceps .....	487
		Mc Indoe Scissors .....	62
		Mc Kenzie Clip Applying Forceps .....	418
		Mc Kenzie Hand Drills .....	402
		Mcgee Micro Ear Forceps .....	506
		Mcindoe Tissue & Dressing Forceps .....	101
		Mcintosh Laryngoscope Set .....	06
		Mcivor Mouth Gage .....	537
		Mclean Obstetrical Forceps .....	399
		Mead Bone Rongeur .....	480
		Mead Mallets .....	440
		Measuring Jug .....	566
		Medicine Cup Graduated.....	566

## M

M.G.H (Mass. General Hospital)	
Needle Holders .....	165
Mac + Miller Combo Laryngoscope Set.....	08
Mac + Miller Combo Laryngoscope .....	08
Mac Disposable Laryngoscope Set.....	09
Mac Laryngoscope Set.....	09
Macdonald Dissector .....	521
Macphail Needle Holders .....	169
Magill Catheter Forceps .....	04
Maier Sponge & Dressing Forceps.....	155
Malleable Retractor .....	264
Malleolar Bone Holding Forceps .....	434
Malleolar Countersink.....	420
Mallets .....	439
Maltz Rasp.....	526
Mannerfelt Hooklet .....	205, 218
Mannerfelt-Langenbeck Hooklet .....	205
Marbach Bandage Scissors.....	78
Markham/Meyerding Retractor .....	268
Markwalder Bone Cutting Forceps .....	486
Marquardt Bone Rongeur .....	484
Marschik-Krone Tonsil Holding Forceps .....	541
Martel Haemostatic Forceps.....	154
Martin Applicator .....	199
Martin Obstetrical Measuring Forceps.....	398
Martin Retractor .....	250
Martin Uterine Sounds .....	383
Martin Vaginal Specula .....	370
Martin-Cartilage Scissors .....	62
Martini Bone Curettes Double-ended .....	444
Masing Alar Hooklet.....	515
Masing Osteotome .....	517
Masson Needle Holders T.c.....	184
Masson Needle Holders .....	166

# INDEX

DESCRIPTION	PAGE #	DESCRIPTION	PAGE #
Meeker Haemostatic Forceps.....	124	Millin's Suction Tube .....	13
Mesh Basket .....	568	Mills Scissors .....	53
Metal Nasal Tips .....	494	Mills Vascular Needle Holders T.c .....	185
Metzenbaum Delicate Scissors T.c. ....	89, 90	Milne Murray Obstetrical Forceps.....	400
Metzenbaum Dissecting Scissors .....	42, 43	Mini Countersink .....	420
Metzenbaum Needle Holders T.c.....	186	Mini Drill Sleeve .....	427
Metzenbaum Needle Holders .....	168	Mini Lambotte Osteotomes.....	457
Metzenbaum Super Cut Scissors .....	83	Mini Lexer Gouge .....	455
Metzenbaum-Baby Dissecting Scissors .....	43	Mini Otoscope Set .....	05
Metzenbaum-Jamison Dissecting Scissors .....	43	Mini-Gemini Haemostatic Forceps .....	133
Metzenbaum-Lahey Scissors T.c.....	91	Mini-Roux Retractors .....	231
Meyerding Retractor .....	229, 251, 468	Mini-Townsend Uterine Biopsy Forceps .....	392
Michel Suture Forceps.....	200	Mirco Cup Forceps .....	415
Micro Alligator Forceps .....	415	Miskimon Retractor.....	269, 270
Micro Alligator Scissors .....	415	Mixer Gall Stone Forceps .....	357
Micro Derf Needle Holders T.c.....	181	Mixer Haemostatic Forceps.....	132, 137
Micro Dissecting Scissors.....	75	Mixer Operating Scissors .....	40
Micro Ear Forceps & Mastoid Rongeurs .....	504	Mixer-O'Shaugnessy Haemostatic Forceps ....	132
Micro Ear Forceps .....	503, 506	Moberg Retractor .....	209
Micro Forceps .....	109, 110	Mod. Martin Dressing Forceps .....	96
Micro Grasping Forceps .....	415	Mod. Michel Suture Forceps.....	200
Micro Hook .....	471	Mod. USA Tissue Forceps .....	100
Micro Needle Holders .....	171	Mod-bonn Operating Scissors .....	65
Micro Ryder Needle Holders T.c.....	172	Model USA Spreader.....	81
Micro Scissors .....	71-76	Model USA Vise Grip Pliers .....	474
Micro-Adson Haemostatic Forceps .....	124	Modell Piccolo Applicator.....	198
Micro-Halsted Haemostatic Forceps .....	120	Modell Tubingen Retractor .....	250
Microsurgery Needle Holders T.c.....	184, 186	Modell USA Dressing Forceps.....	107
Microvascular Needle Holders T.c. ....	172, 177	Modell Wurzburg Mouth Gage.....	537
Middeldorpf Cheek Retractor.....	540	Modified Wien Nasal Speculum.....	508, 511
Middeldorpf Retractors .....	227, 228	Modified-USA Gynecology Scissors .....	78
Mikulicz Haemostatic Forceps .....	129, 143	Mogen Circumcision Clamp.....	359
Mikulicz Retractors .....	243, 245	Mollinson Tonsil Dissector .....	546
Miller Alveotomy File.....	453	Mollison Retractor .....	267, 273
Miller Disposable Laryngoscope Set .....	09	Molt Mouth Gag .....	535
Miller Dressing Forceps .....	104	Möltgen Caliper.....	11
Miller Laryngoscope Set .....	09	Morris Retractor .....	260
Miller Rasp.....	526	Morris-De Bakey Vascular Clamps .....	298
Miller Retractor .....	209	Morse Scissors .....	58
Miller-Colburn Bone File .....	453	Morse-Favaloro Sternal Retractor .....	323
Miller-Colburn Rasp .....	526	Mouth Gag, Lip & Cheek Retractors.....	536
Milligan Cranial Rongeurs .....	417	Mouth Gage .....	538, 539
Milligan Retractor.....	268	Moynihan Gall Duct Dilator.....	353
Millin Bladder Neck Spreader .....	359	Moynihan Haemostatic Forceps .....	129
Millin Capsule Forceps .....	358	M-Schmidt Tongue Depressor .....	534

DESCRIPTION	PAGE #	DESCRIPTION	PAGE #
Murphy Retractors .....	212	Non-Perforating Towel Forceps .....	148
Museux Tenaculum Forceps .....	375	Norfolk & Norwich Retractor .....	274
Museux Tonsil Forceps .....	545	Northbent Stitch Scissors .....	67
<b>N</b>		Noto Sponge & Dressing Forceps .....	161
Nabatoff Varicose Vein Probe Complete Set .....	330	Nott Vaginal Speculum .....	362
Naegele Obstetrical Forceps .....	399	Novak Suction Cannula Curette .....	384
Naegele Perforator Forceps .....	395	Noyes Micro Scissors .....	71, 73
Nager Tonsil Snares .....	549	Nussbaum Intestinal Clamp Forceps .....	345
Nail Extracting Forceps .....	472	Nussbaum Intestinal Clamps .....	340
Nail Extractor .....	476	<b>O</b>	
Nail Nipper .....	201	O'Brien Needle Holders T.c .....	184
Nail Scissors .....	70	O'Brien Vascular Scissors .....	54
Nail Splitting Forceps .....	472	O'Shaughnessy Haemostatic Forceps .....	123
Nasal Scissors & Nasal Tompon .....	514	O'Sullivan - O'connor Retractor .....	282, 373
Nasal Speculum .....	508-511	Ochsner Suture Forceps .....	200
Nasal Suction Tube .....	531	Ochsner Trocar .....	22
Naunton Morgan Needle Holders .....	164	Ochsner Vascular Clamps .....	293
Needle Case .....	564, 566	Oldberg Laminectomy Rongeur .....	407
Needle Holders T.c .....	172-175, 177-189	Olivecrona Knives .....	33
Needle Holders .....	162-171, 176	Olivecrona Vascular Scissors .....	61
Needle Nose Pliers .....	473, 476	Olivecrona Dura Dissectors .....	470
Negus Chest Support For Mouth Gag .....	539	Olivecrona Nasal Scissors .....	514
Negus Haemostatic Forceps .....	129	Ollier Retractors .....	227, 235
Negus Suction Dissector .....	521	Olsen-Hegar Needle Holders T.c .....	174, 179
Neivert Chisel .....	518	Olsen-Hegar Needle Holders .....	166, 176
Neivert Hooklets .....	213	Ombredanne Mallet .....	441
Neivert Needle Holders T.c .....	182	Operating Fine Scissors .....	65
Neivert Needle Holders .....	167	Operating Laryngoscope .....	557
Nelaton Probe .....	196	Operating Scissors .....	65
Nelson Lung Dissecting Scissors .....	57	Operating, Dissecting Scissors T.c .....	91
Nelson Tissue Forceps .....	102	Operating, Dissecting Scissors .....	39, 40, 42, 45, 46
Nelson Trocar .....	21	Ortho / With Plastic Caps Mallet .....	441
Nelson Trocar .....	22	Ortho Bone Clamp .....	432
Nerve Probe Endoscopic .....	451	Ortho Mallet .....	441
Neumann Vascular Scissors .....	59	Orthopaedic Mallet .....	441
Neuro-Duoflex Hammer .....	01	Orthopaedics Wire Cutter .....	490
Neutral & Load Drill Guide .....	427	Osteotomes .....	519
New Orleans Needle Holders T.c .....	172, 179	Otoscope / Ophthalmoscope Set .....	05
New Orleans Needle Holders .....	165, 176	Otoscope Set .....	05
New Port Vaginal Retractor .....	372	Overholt Haemostatic Forceps .....	131
News Hooklet .....	555	Overholt-Geissendoerfer Haemostatic Forceps .....	131
Niro Hooklet .....	203	Overholt-Mixer Haemostatic Forceps .....	125
Nissen Haemostatic Forceps .....	125		

# INDEX

DESCRIPTION	PAGE #	DESCRIPTION	PAGE #
<b>P</b>			
Parametrium Haemostatic Forceps .....	139	Plaster Scissors .....	77-79
Parametrium Operating Scissors T.c. ....	87	Plaster Shears .....	80
Parker Retractors .....	232	Plester Retractor .....	269, 271
Parker-Langenbeck Retractors .....	232	Plester Suction Tube .....	18, 19
Parker-Mott Retractors .....	232	Plester Suction Tube .....	531
Partsch Gouges .....	458	Plester Tympanum Needle .....	499
Partsch Mallets .....	440	Ploitzer Ear Specula .....	493
Patella Bone Holding Forceps .....	434	Politzer Air Douche .....	494
Paul Hooklet .....	209	Politzer Tympanum Needle .....	497
Payr Intestinal Clamp .....	343	Pool Suction Tube .....	16
Payr-Baby Intestinal Clamp .....	343	Poots-Smith Dressing Forceps .....	98
Pean Haemostatic Forceps .....	125, 128, 129, 151	Potts Tenotomy Scissors .....	49
Pederson Vaginal Speculum Leep / Lietz .....	360	Potts Vascular Clamps .....	295
Pederson Vaginal Speculum .....	360	Potts-De Martel Scissors .....	53
Peers-Bertman Towel Forceps .....	149	Potts-Reynolds Tenotomy Scissors .....	49
Peet Splinter Forceps .....	115	Potts-Smith Dressing Forceps T.c. ....	118
Pelkmann Sponge Forceps .....	159	Potts-Smith Scissors T.c. ....	93
Pelvic Instruments .....	437	Potts-Smith Scissors .....	53, 62
Pelvic Reduction Forceps Asymmetric .....	436	Potts-Smith Super Cut Scissors .....	84
Pelvic Reposition Forceps .....	435-437	Potts-Smith Tissue Forceps .....	98
Penfield Dura Dissectors .....	417	Potts-Smith Vascular Scissors .....	52, 57
Penfield Elevator Endoscopic .....	451	Pozzi Gyne Tenaculum Forceps .....	374
Penfield Elevators .....	452	Pozzi Tonsil Forceps .....	543
Pennington / Siezing Haemostatic Forceps .....	154	Pratt Ehtmoid Curettes .....	550
Pennington Raspatory .....	522	Pratt Gyne Uterine Dilators .....	387
Pennybacker Periosteal Elevators .....	463	Pratt Haemostatic Forceps .....	154
Penzzuoli Vascular Clamps .....	311	Pratt Rectal .....	347
Percussion Hammers .....	01, 02	Pratt Tenaculum Forceps .....	375
Percy Retractor .....	438	Presbyterian Tubing Clump .....	150
Perforated Baskets .....	568	Price Thomas De Bakey Vascular Clamps .....	319
Perforated Box .....	562	Price-Thomas De Bronchus Clamp .....	319
Perforated Tray .....	563	Prince Scissors .....	64
Periosteal Elevator .....	461, 466	Probes .....	197
Perkins Retractor .....	271	Prostatic Retractor .....	352
Perthes Reamer .....	453	Providence-Hospital Haemostatic Forceps .....	120
Phaneuf Haemostatic Forceps .....	142	Pryor-Pean Retractor .....	255
Phaneuf Haemostatic Forceps .....	144	Putti Elevators .....	453
Pierce Trocar .....	22		
Pin Wrench .....	425	<b>Q</b>	
Pinard Aluminium Stethoscopes .....	03	Quinby Vascular Scissors .....	60
Pinard Wooden Stethoscopes .....	03	Quire Ear Polypus Forceps .....	501
Piper Obstetrical Forceps .....	399		
Pituitary Rongeur .....	413		

DESCRIPTION	PAGE #	DESCRIPTION	PAGE #
<b>R</b>			
Rabiner Hammer .....	02	Richardson Retractor.....	259
Ragnell Scissors T.c. ....	92	Richardson Retractors .....	258
Ragnell-Davis Retractors .....	215	Richardson/kelly Retractor .....	251
Ralk Bone Drills .....	422	Richardson-Eastman Retractor .....	259
Ralk Splinter Forceps.....	115	Richter Operating Scissors.....	40
Ramathibodi Tubal Hook .....	372	Richter Retractor .....	266
Ramathibodi Uterine Manipulator .....	372	Richter-Heath Suture Forceps .....	200
Ramplsey Sponge Forceps .....	160	Righby Retractor.....	270
Ramsay Tissue & Dressing Forceps .....	101	Ring Cutter .....	472
Ramsay Tissue & Dressing Forceps .....	101	Roberts Haemostatic Forceps .....	135
Randall Kidney Stone Forceps .....	350	Robinson's Periosteal Elevators .....	462
Raney Clip Applying Forceps .....	418	Rochard Retractor .....	284
Rankin Haemostatic Forceps .....	121, 122	Rochester Needle Holders T.c .....	183
Raspatory .....	471	Rochester-Carmalt Haemostatic Forceps .....	128, 129
Ratchet Fixation Bone Holding Forceps .....	434	Rochester-Pean Haemostatic Forceps.....	126
Ray Pituitary Curette .....	446	Roder Tonsil Snares .....	549
Razor .....	36	Roeder Towel Forceps.....	148
Recamier Uterine Curette.....	379, 380	Rogge Sterilizing Forceps .....	569
Reduction Bone Holding Forceps .....	434	Rollet (Blair) Hook .....	209
Reduction Forceps .....	434	Rollet Hook .....	209
Rees Scissors T.c .....	91	Rollet Hooklet .....	202
Reil Bone Holding Forceps .....	434	Roosevelt Intestinal Clamp Forceps .....	346
Reiner Ear Syringe .....	502	Rose Retractor .....	230, 555
Renal Artery Clamng Forceps .....	318	Rosen Ear Specula.....	493
Resano Dressing Forceps T.c.....	117	Rosen Tympanum Needle .....	499, 500
Resano Intestinal Forceps .....	337	Rosenbrg Tonsillectomy Forceps.....	560
Resano Vascular Scissors .....	57	Roser-Konig Mouth Gag.....	535
Resection Knife .....	36	Ross Retractor.....	252
Retractor .....	224	Round Badpan.....	567
Retractor For Knee .....	467	Round Cut Scissors.....	66
Retractor.....	213-216	Roux Cheek Retractor .....	540
Retractors ....	219-223, 225-226, 228-236, 239-247	Roux Retractors.....	231
Retractors, Vein Hooks.....	251	Roux-Magnus Retractors.....	231
Reverdin Needles .....	190, 191	Rubio Wire Twister T.c.....	180
Reverdin Retractor .....	264	Rumel Haemostatic Forceps .....	132
Reynolds Operating Scissors .....	45	Ruskin Bone Rongeur .....	484
Rhoton Micro Dissection Instruments .....	450	Ruskin Bone Rongeurs.....	483
Rhoton-Merz Brain Retractor Set .....	401	Ruskin Bone Splitting Forceps .....	488
Rib Elevator Endoscopic .....	449	Ruskin-Liston Bone Cutting Forceps .....	487
Rib Retractors.....	323	Ruskin-Mini Bone Rongeurs.....	483
Ribbon Retractor .....	264	Russel-Davis Mouth Gage.....	538
Ricard Retractor .....	285	Russian-Modell Tissue Forceps .....	103
Richardson Eastman Retractors.....	230	Rydel-Seiffer Tuning Forks .....	496
		Ryder French-Eye/Standard/Micro Needle Holders T.c.....	178

# INDEX

DESCRIPTION	PAGE #	DESCRIPTION	PAGE #
Ryder Needle Holders T.c.....	177	Schaedel Towel Forceps.....	148
<b>S</b>		Scheinmann Tonsillectomy Forceps .....	560
Saalfeld Miliium Knife & Comedone Extractor...324		Scherback Vaginal Specula .....	371
Sachs Cranial Rongeurs.....	417	Schindler Haemostatic Forceps.....	140
Sachs Hooklet .....	203	Schlesinger Laminectomy Rongeur.....	406
Sachs Nerve Elevator.....	452	Schmeden Nasal Cutting Forceps.....	529
Sachs Nerve Hooks.....	416	Schmieden Needle .....	191
Sachs Nerve Separator & Spatula.....	416	Schmieden-Dick Needle .....	191
Saenger Placenta Forceps .....	396	Schmieden-Taylor Vascular Scissors.....	61
Safety Super Cut Scissors.....	82	Schmieden-Taylor .....	60
Sairges Tenaculum Forceps .....	375	Schnidt / Sawtell Haemostatic Forceps .....	124
Samii.....	105	Schoemaker-Loth Scissors.....	66
Sanvenero Operating Scissors.....	45	Schoenbore Retractors .....	215, 229, 555
Saroot Haemostatic Forceps .....	123	Schröder Gyne Tenaculum Forceps .....	374
Sarot Needle Holders T.c.....	182	Schröder Tenaculum Forceps.....	374
Sarot Needle Holders T.c.....	174	Schroeder Tonsil Forceps.....	542-544
Sarot Needle Holders T.c.....	178	Schroeder Uterine Scoops .....	377
Sarot Needle Holders .....	163	Schuardt Rib Sternum Shears .....	329
Satinsky De Bakey Vascular Clamps.....	310	Schubert Biopsy Forceps .....	394
Satinsly Vascular Scissors.....	61	Schuhknecht Retractor .....	270
Satterlee Saw .....	36	Schuknecht Tympanum Needle.....	499
Satterlee Saw .....	438	Schuknecht Wire Cutting Scissors .....	69
Sauerbruch Retractors .....	235, 236, 239	Schulze Uterine Flushing Tube.....	386
Sauerbruch Rib Sternum Shears.....	329	Schulze-Bergmann Intestinal Rectal .....	348
Sauerbruch Rongeur Forceps .....	485	Schumacher Bandage Scissors .....	78
Sauerbruch-Frey Bone Nibblers .....	327	Schumacher Sternum Shears .....	327
Sawtell Haemostatic Forceps .....	123	Schumacher Uterine Biopsy Forceps .....	390
Sawyer Retractors .....	258	Schumacher-Nan-Doren Biopsy Forceps.....	395
Scaler Box .....	564	Schweckendiek Tonsil Scissors .....	533
Scaler Tray .....	564	Scoville Bone Curettes .....	445
Scalp-Contour Retractor.....	266	Scoville Nerve Hooks .....	416
Scalpel Handle .....	25, 26, 28	Scoville Retractor .....	216, 468
Scalpel Handle #3 .....	25	Scoville Ruptured Disc Curette.....	445
Scalpel Handle #3 / Graduated .....	25	Scoville-Richter Retractors .....	283
Scalpel Handle #3 Long Angled .....	26	Screw Driver .....	424
Scalpel Handle #4 .....	25	Screw Forceps .....	425
Scalpel Handle 3l Long.....	26	Screw Nut Wrench .....	478
Scalpel Handle 4l .....	25	Scudder Intestinal Clamps.....	340
Scalpel Handle 4l Long.....	26	Sebilleau Elevator .....	460
Scalpel Handle, #7 .....	26	Sedillot Periosteal Elevators .....	462
Scalpel Handle,#3, #4 .....	26	Segond Knives .....	33
Scalpel Handles .....	27	Segond Myoma Knife .....	376
Scalpel Plastic Handle .....	25, 26	Segond-Landau Haemostatic Forceps .....	140
		Seiffert Applicator.....	198
		Self - Centering Bone Holding Forceps .....	430



DESCRIPTION	PAGE #	DESCRIPTION	PAGE #
Sellers Rib Contractor .....	320	Sims Suction Curettes .....	377
Semb Bone Cutting Forceps .....	488	Sims Uterine Curette .....	381-384
Semb Bone Holding Forceps .....	328, 430	Sims-Kelly Retractor .....	261
Semb Bone Rongeurs .....	483	Sims-Maier Sponge & Dressing Forceps .....	156
Semken Dressing Forceps .....	97	Sims-Special Uterine Sounds .....	383
Semken Tissue Forceps .....	99	Singley-Tuttle Intestinal Tissue Forceps .....	103
Semm Retractor .....	286	Singley-Tuttle Tissue Forceps .....	103
Semm Vaginal Speculum .....	362	Sinus & Ethmoid Curettes .....	550
Senn Mallow Retractor .....	214	Skene Tonsil Forceps .....	543
Senn Retractor .....	469	Skull Traction Tongs .....	403
Senn-Green Retractors .....	215	Sleeve Holding .....	424
Senning Needle Holders T.c. ....	173	Slip Joint Vise Grip Pliers .....	474
Senning Needle Holders .....	165	Sluder-Ballenger Tonsil Snares .....	549
Senn-Mueller Retractors .....	214	Small Countersink .....	420
Septum & Periosteal Elevators .....	523	Smellie Decapitating Hook .....	395
Septum Chisels, Septum Gouges .....	517	Smellie Perforator Forceps .....	395
Septum Elevators & Periosteal Elevators .....	520	Smith (Mod. USA) Scissors .....	79
Septum Elevators, Periosteal Elevators .....	521	Smith Peterson Gouges .....	456, 458
Septum Forceps .....	512, 513, 525	Smith Peterson Osteotomes .....	456
Septum Osteotome .....	519	Smith Wire Cutting Scissors .....	69
Septum, Periosteal Elevators .....	522	Smith-Blue Intestinal Rectal .....	348
Seutin Shears .....	489	Smith-Peterson Gouge .....	459
Sexton Tympanum Needle .....	497	Smith-Peterson Osteotome .....	459
Seyffert Vaginal Speculum .....	361	Smithwick Hook & Dissector .....	451
Shapleigh Ear Curette .....	498	Snellen Curette .....	499
Sharp Hook .....	425	Socket Wrench .....	425
Shaving Mug .....	567	Somer Kidney Stone Forceps .....	351
Shortbent Stitch Scissors .....	67	Spatula .....	198
Siebold Scissors .....	47	Speaking Tube .....	553
Siegle Diagnostic Head Complete Set .....	494	Spencer / Delicate Stitch Scissors .....	67
Silver Chisel .....	518	Spencer Coronary Needle Holders T.c .....	186
Simon / Schroder Uterine Scoops .....	378	Spencer Stitch Scissors .....	67
Simon Bone Curettes .....	443	Spencer-Wells Haemostatic Forceps .....	125
Simon Bone Curettes .....	446	Sphenoid Bone Punches .....	528
Simon Hook .....	206	Splinter Forceps .....	114
Simon Knives .....	34	Split Lamp .....	565
Simon Retractor .....	250	Spratt Bone Curettes .....	442
Simon Vaginal Speculum .....	366	Spratt Bone Curettes .....	445
Simplex Tongue Depressor .....	540	Sprit Lamp .....	566
Simpson Obstetrical Forceps .....	399	Spurling Laminectomy Rongeur .....	406
Simpson Uterine Sounds .....	383	Sputum Mug .....	567
Simpson-Braun Obstetrical Forceps .....	399	S-Shaped Retractors .....	242
Sims Operating Scissors T.c. ....	88	St Clair Thompson Elevator .....	522
Sims Rectal .....	347	St. Clair-Thomson Adenoid Curettes .....	551
Sims Scissors .....	47	St. Marks Retractor .....	254

# INDEX

DESCRIPTION	PAGE #	DESCRIPTION	PAGE #
Thorek Scissors.....	44	Trousseau Tongue Holding Forceps.....	554
Thorek-Feldman Scissors.....	44	Troutman Micro Scissors.....	72
Thudichum (Golfsmith) Nasal Speculum.....	509	Troutman-Chris Blade Holder.....	28
Tieck-halle Nasal Speculum.....	510	Tubbs Dilator Forceps.....	321
Tischler Biopsy Forceps.....	394	Tubing Clump.....	150
Tischler Uterine Biopsy Forceps.....	389, 392, 393	Tuebinger Modell Retractor.....	269
Tischler-Kevorkian Uterine Biopsy Forceps.....	389	Tuffier / Haberer Retractor.....	264
Tischler-Morgan Uterine Biopsy Forceps.....	393	Tuffier Haemostatic Forceps.....	154
Tissue & Dressing Forceps T.c.....	111, 118	Tuffier Intestinal Forceps.....	332
Tissue & Dressing Forceps.....	95	Tuffier Retractor.....	244, 245
Tissue Forceps.....	119	Tuffier Rib Retractor.....	323, 324
Tissue Lifter.....	471	Tumarkin Ear Specula.....	493
Tivnen Tonsil Seizing Forceps.....	507	Tuning Forks.....	495, 496
Tobold Laryngeal Polypus Forceps.....	558	Turner-Doyen Retractors.....	252
Tobold Tongue Depressor.....	534	Tyding Tonsil Snares Forceps.....	548
Toenis Dissecting Scissors.....	58	Tydings Tonsil Seizing Forceps.....	507
Toennis Dura Dissectors.....	470	Tympanum Needle & Ear Curettes.....	498
Toennis Hooklet.....	202	Tympanum Needle.....	497
Toennis Needle Holders T.c.....	186		
Toennis Needle Holders.....	170	<b>U</b>	
Toennis Nerve Hooks.....	416	Uckermann Tracheotomy Trocar.....	554
Toennis Vascular Scissors.....	60	Uffenorde bone Curettes.....	443
Toennis-Adson Scissors T.c.....	94	Ulrich Bone Holding Forceps.....	430, 431
Toennis-Adson Vascular Scissors.....	60	Ulrich Sponge Forceps.....	158
Tohoku Towel Forceps.....	149	Univ. Minnesota Tongue Depressor.....	540
Tongue Depressor.....	534	Universal (Colour Available).....	77
Tonsil Forceps.....	545	Universal Bandage Scissors.....	77
Tonsil Grasping Forceps.....	542	Universal Bone Rongeurs.....	479
Tonsil Snares.....	548, 549	Universal Laryngeal.....	557
Tonsil, Nasal Scissors.....	63	Universal Scissors T.c.....	492
Tonsillectomy Forceps Exchangeable Tips.....	560	Universal Scissors.....	477
Townley Caliper.....	11	Universal Trocar.....	20
Tracheotomy Set.....	556	Unna Comedone Extractor.....	324
Traction Cable.....	330	Urinal - Female.....	567
Traube Hammer.....	02	Urinal - Male.....	567
Travers Retractor.....	270	Uro-Tangential Gall Stone Forceps.....	357
Trelat Vaginal Speculum.....	362	Usa Retractors.....	230
Trethowan's Periosteal Elevators.....	462	Us-Army Retractors.....	230
Treves Tissue & Dressing Forceps.....	101	Uterine Biopsy Forceps.....	389
Trocar.....	15	Utility Shears.....	489
Trocars / Suction Tubes.....	20	Utility Sterilizing Forceps.....	569
Trocars.....	21, 22		
Troeltsch Ear Forceps.....	507		
Troemner Hammer.....	01		
Troemner-Simplex Hammer.....	01		

DESCRIPTION	PAGE #	DESCRIPTION	PAGE #
<b>V</b>			
Vacuum Curettes .....	385	Wangensteen Dressing Forceps T.c. ....	118
Vaginal Specula & Retractors .....	369	Wangensteen Dressing Forceps .....	98
Vaginal Specula, Vaginal Retractors .....	367	Wangensteen Needle Holders T.c. ....	175
Vaginal Speculum .....	366	Wangensteen Needle Holders .....	166, 168
Valleix Uterine Sounds.....	383	Wangensteen Tissue Forceps T.c.....	118
Van Buren Dilator.....	354	Wartenberg Pinwheel .....	02
Van Doren Biopsy Forceps.....	395	Wash Basin.....	565
Vascular Scissors .....	52-61	Wassmund Retractors .....	229
Vascular, Dissecting & Plaster Scissors T.c.....	92	Watron-Ceyne Raspatory .....	521
Vascular, Dissecting Scissors T.c.....	93	Watson-Williams Bone Punche .....	528
Vascular, Enterotomy Scissors .....	62	Watson-Williams Tonsil Punch Forceps.....	529
Vein Artery Clamp Forceps.....	289	Weber Aesthesiometer .....	03
Verbrugge Bone Holding Forceps .....	433	Weber Vascular Clamps .....	297
Vernier Caliper .....	11	Webster Needle Holders T.c.....	182
Vezien Operating Scissors .....	46	Webster Needle Holders.....	162
Vickers Mallets.....	440	Wecker Micro Scissors .....	71
Vienna Nasal Speculum.....	511	Weider Tongue Depressor .....	534
Virchow Dissecting Knives.....	35	Weil - Blakesley Laminectomy Rongeur.....	414
Vise Grip Pliers .....	475	Weil-blakesley Bone Punche .....	528
Vogel Trocar .....	22	Weil-Blakesley Laminectomy Rongeur.....	408
Volkman Retractor .....	214	Weinberg Vagotomy Retractor (Joe's Hoe) .....	252
Volkman Bone Curettes Double-ended .....	444	Weingärtner Alligator Ear Forceps.....	502
Volkman Bone Curettes.....	442	Weissbarth Vaginal Specula .....	369
Volkman Hooklets.....	212	Weitlaner Retractor.....	271, 272
Volkman Retractors .....	212, 233, 234	Wertheim Haemostatic Forceps .....	144, 146, 147
Voltolini (Dplay) Nasal Speculum .....	509	Wertheim Needle Holders T.c.....	173
<b>W</b>			
Wachenfeldt Suture Forceps .....	200	Wertheim Needle Holders.....	166
Wagener Ear Hooklet .....	500	Wertheim Parametrium Clamps.....	145, 146
Wagener Hooklet .....	205	Wertheim-Cullen Haemostatic Forceps.....	147
Wagner Gum Scissors.....	64	Westcott Micro Scissors .....	72, 73
Wagner Laminectomy Rongeur.....	408	Westermark Haemostatic Forceps .....	141
Walb Dissecting Knives .....	35	Westmacott Septum Forceps .....	512
Waldmann Bandage Scissors.....	78	Wetheim Operating Scissors .....	46
Wallich Ovum Forceps.....	396	White Tonsil Forceps .....	542
Walsham Septum Forceps .....	530	Whitehead Mouth Gag.....	536
Walter Chisel .....	518	Whitehead-Jennings Mouth Gag.....	536
Walton Operating Scissors .....	65	Wickham Bulldog Holding Forceps.....	292
Walton Retractor.....	266	Wickham Mini Bulldog Holding Forceps.....	292
Walton-Liston Bone Cutting Forceps .....	487	Wiener Hook.....	202
		Wikstroem Haemostatic Forceps.....	136
		Wilde Intervertebral Disc Laminectomy Rongeur.....	414
		Wilde Nasal Polypus Snare .....	514
		Willet-Martel Haemostatic Forceps.....	154
		Willett Obstetrical Forceps.....	397

# INDEX

DESCRIPTION	PAGE #	DESCRIPTION	PAGE #
William Lacrimal Probes .....	195	Yasargil .....	105
Williams Intestinal Forceps .....	331	Yasargil-Sami Tissue Forceps .....	104
Williams Screw Driver .....	424	Yeomann Biopsy Punching Forceps .....	341
Williger Bone Curettes Double-ended .....	444	Young Needle .....	191
Williger Bone Curettes .....	442	Young Prostatic Retractor .....	352
Williger Mallets.....	440	Young Retractor.....	256
Williger Periosteal Elevators .....	462	Young Tongue Holding Forceps.....	554
Williger Retractor .....	273		
Wilmer Iris Scissors .....	49		
Winkelmann Circumcision Clamp .....	359		
Winter Placenta Forceps .....	396		
Winterton Vaginal Speculum.....	362		
Wire Bending Pliers .....	477		
Wire Cutter .....	477		
Wire Cutter T.c.....	492		
Wire Cutters.....	491		
Wire Cutting Pliers T.c .....	492		
Wire Cutting Scissors .....	68, 69		
Wire Cutting Scissors T.c.....	94		
Wire Forceps .....	476		
Wire Instruments .....	477		
Wire Retaining Retractor .....	265		
Wire Tightening Pliers .....	475		
Wire Tightening Pliers T.c. ....	180		
Wire Twisters T.c.....	180		
Wittner Uterine Biopsy Forceps.....	391		
Wolff Plaster Shears .....	489		
Wolff Saw.....	81		
Woodson Dural Separator/packer .....	452		
Woodson Elevator/spatula.....	452		
Wrigley Obstetrical Forceps.....	400		
Wuaugh Tissue & Dressing Forceps .....	101		
Wullstein Micro Ear Forceps.....	505		
Wullstein Retractor .....	270		
Wullstein Suction Tube .....	23		

## Z

Zaikind Lung Retractor .....	261
Zaufal Ear Hooklet.....	500
Zaufal-Jansen Bone Rongeurs.....	483
Zenker Haemostatic Forceps .....	134
Zenker Retractor.....	226, 263
Ziegler Cilia Forceps .....	113
Zöllner Ear Polypus Forceps .....	501
Zollner Ear Specula .....	493
Zweifel Needle Holders T.c.....	189

## Y

Yankauer Hooklet .....	203
Yankauer Suction Tube.....	17, 20
Yasargil Haemostatic Forceps .....	125
Yasargil Laminectomy Rongeur.....	407
Yasargil Lure-Lock Cone Suction Tubes.....	24
Yasargil Suction Tube .....	23
Yasargil Tissue Forceps.....	104



# ZIANA INDUSTRIES

 [sales@zianaindustries.com](mailto:sales@zianaindustries.com)  
[expziana@gmail.com](mailto:expziana@gmail.com)

[info@zianaindustries.com](mailto:info@zianaindustries.com)

 [www.zianaindustries.com](http://www.zianaindustries.com)

 +92-52-4261495 , +92-52-4265791

 +92-321-9408040

 +92-52-4264970

**Islam Nagar Road Pacca Garah  
Sialkot 51310 - Pakistan.**